

GENERAL CATALOG

DRILLING

we improve, we evolve, we **ADD**

JosS
◉

JosS d.o.o.

Sokolska 45, 2000

Maribor, Slovenia

+386 2 421 57 20

+386 41 705 509

joss@joss.si

www.joss.si

2025





Tungaloy's Insights – Smart Manufacturing

Tungaloy, as one of the leaders in the metal removal industry, offers the latest innovations in grades and geometries for superb performance and tool life.

*Tungaloy's latest
innovations in cutting
tools contribute to
carbon neutrality*



VOL. 3 DRILLING

A	Grade	A001 -
B	Insert	B001 -
C	External Toolholder	C001 -
D	Internal Toolholder	D001 -
E	Threading Tool	E001 -
F	Parting, Grooving	F001 -
G	Miniature Machining	G001 -
H	Milling Cutter	H001 -
I	Endmill	I001 -
J	Drilling Tool	J001 -
K	Tooling System	K001 -
L	User's Guide	L001 -
M	Alphanumeric Index	M001 -

About Tunggaloy Cutting Tool Catalog

■ Note in using this catalog:

- ★ This catalog provides the information of Tunggaloy's cutting tools as of March 2023.
- ★ The specifications are subject to change without prior notice for product improvements. Also, the products may be discontinued in the future due to the development of new products.
- ★ The dimensions of all products are shown in millimeters (mm).
- ★ For indexable tools, such as drill bodies, applicable inserts or heads need to be ordered separately.

■ How to use this catalog:

VOL. 3
DRILLING

Grade A001 -
Insert B001 -
External Toolholder C001 -
Internal Toolholder D001 -
Threading Tool E001 -
Parting, Grooving F001 -
Miniature Machining G001 -
Milling Cutter H001 -
Endmill I001 -
Drilling Tool **J001 -**
Tooling System K001 -
User's Guide L001 -

2 Alphanumeric Index M001 -

J001

1

DRILLMASTER
D L/D=1.5
Exchangeable head drill, L/D = 1.5, Taper type

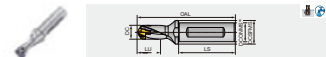

Designation	CC	CCOMMS	DCSFRM	LU	LS	DRIFTHN	DMC	DMF	Pocket size	Head
T0000P-S-1	8	12	14	12	45	62.9	68	47	6.3	DMF10C-DMF20C
T0000P-S-2	10	14	16	14	45	70	76.4	54.1	7	DMF10C-DMF20C
T0000P-S-3	12	16	18	16	45	77.2	86.8	61	8	DMF10C-DMF20C
T0000P-S-4	14	18	20	18	45	84.1	97.4	68	9	DMF10C-DMF20C
T0000P-S-5	16	20	22	20	45	90.4	108	75.4	10	DMF10C-DMF20C
T0000P-S-6	18	22	24	22	45	96.8	118.6	82.4	11	DMF10C-DMF20C
T0000P-S-7	20	24	26	24	45	103.2	128.8	89.4	12	DMF10C-DMF20C
T0000P-S-8	22	26	28	26	45	109.6	139	96.4	13	DMF10C-DMF20C
T0000P-S-9	24	28	30	28	45	116	149.2	103.4	14	DMF10C-DMF20C
T0000P-S-10	26	30	32	30	45	122.4	159.4	110.4	15	DMF10C-DMF20C
T0000P-S-11	28	32	34	32	45	128.8	169.6	117.4	16	DMF10C-DMF20C
T0000P-S-12	30	34	36	34	45	135.2	179.8	124.4	17	DMF10C-DMF20C
T0000P-S-13	32	36	38	36	45	141.6	190	131.4	18	DMF10C-DMF20C
T0000P-S-14	34	38	40	38	45	148	200.2	138.4	19	DMF10C-DMF20C
T0000P-S-15	36	40	42	40	45	154.4	210.4	145.4	20	DMF10C-DMF20C
T0000P-S-16	38	42	44	42	45	160.8	220.6	152.4	21	DMF10C-DMF20C
T0000P-S-17	40	44	46	44	45	167.2	230.8	159.4	22	DMF10C-DMF20C
T0000P-S-18	42	46	48	46	45	173.6	241	166.4	23	DMF10C-DMF20C
T0000P-S-19	44	48	50	48	45	180	251.2	173.4	24	DMF10C-DMF20C
T0000P-S-20	46	50	52	50	45	186.4	261.4	180.4	25	DMF10C-DMF20C

SPARE PARTS

Insert	-	KT000-10
Toolholder	-	K0000-10
Head	-	H0000-10

References pages: Head → J005 - J033
Standard cutting conditions → J033

J012 J001

TID-R-2E L/D=2
Exchangeable head drill, L/D = 2, Cylindrical shank, for external coolant supply

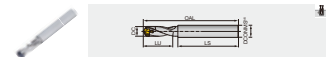

Designation	CC	CCOMMS	LU	LS	DRIFTHN	DMC	DMF	Pocket size	Head	
T0000P-S-1	8	12	14	12	45	62.9	68	47	6.3	DMF10C-DMF20C
T0000P-S-2	10	14	16	14	45	70	76.4	54.1	7	DMF10C-DMF20C
T0000P-S-3	12	16	18	16	45	77.2	86.8	61	8	DMF10C-DMF20C
T0000P-S-4	14	18	20	18	45	84.1	97.4	68	9	DMF10C-DMF20C
T0000P-S-5	16	20	22	20	45	90.4	108	75.4	10	DMF10C-DMF20C
T0000P-S-6	18	22	24	22	45	96.8	118.6	82.4	11	DMF10C-DMF20C
T0000P-S-7	20	24	26	24	45	103.2	128.8	89.4	12	DMF10C-DMF20C
T0000P-S-8	22	26	28	26	45	109.6	139	96.4	13	DMF10C-DMF20C
T0000P-S-9	24	28	30	28	45	116	149.2	103.4	14	DMF10C-DMF20C
T0000P-S-10	26	30	32	30	45	122.4	159.4	110.4	15	DMF10C-DMF20C
T0000P-S-11	28	32	34	32	45	128.8	169.6	117.4	16	DMF10C-DMF20C
T0000P-S-12	30	34	36	34	45	135.2	179.8	124.4	17	DMF10C-DMF20C
T0000P-S-13	32	36	38	36	45	141.6	190	131.4	18	DMF10C-DMF20C
T0000P-S-14	34	38	40	38	45	148	200.2	138.4	19	DMF10C-DMF20C
T0000P-S-15	36	40	42	40	45	154.4	210.4	145.4	20	DMF10C-DMF20C
T0000P-S-16	38	42	44	42	45	160.8	220.6	152.4	21	DMF10C-DMF20C
T0000P-S-17	40	44	46	44	45	167.2	230.8	159.4	22	DMF10C-DMF20C
T0000P-S-18	42	46	48	46	45	173.6	241	166.4	23	DMF10C-DMF20C
T0000P-S-19	44	48	50	48	45	180	251.2	173.4	24	DMF10C-DMF20C
T0000P-S-20	46	50	52	50	45	186.4	261.4	180.4	25	DMF10C-DMF20C

SPARE PARTS

Insert	-	KT000-10
Toolholder	-	K0000-10
Head	-	H0000-10

References pages: Head → J005 - J033
Standard cutting conditions → J033

J012 J001

- 1 Select the tool type at the application index on the left pages.
- 2 The index is in the alphanumeric order. Use it for your product search.

■ How to read the list for the standard items:

- ★ Designations for indexable tools – drill bodies, holders, etc.
 - Orders are to be received for the tools with the designations in the catalog.
- ★ Lineup for drill heads and solid tools
 - Blank : Please contact us regarding the product.

About Tungaloy Cutting Tool Catalog

■ Icons at the left side of each page

External toolholder (cutting edge shape / angle)

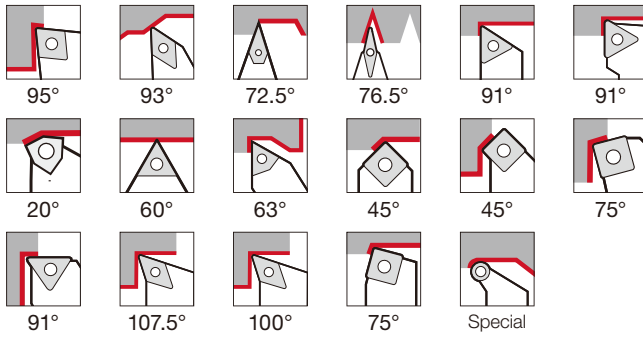

Internal toolholder (cutting edge shape / angle)

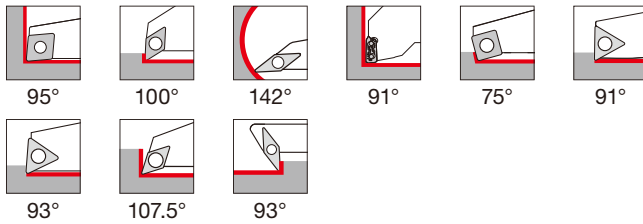

Parting, Grooving

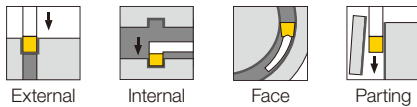

Miniature machining



Mill

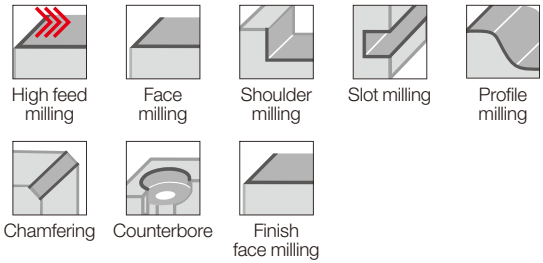

Endmill

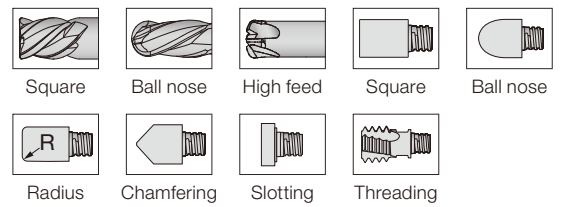

Drill

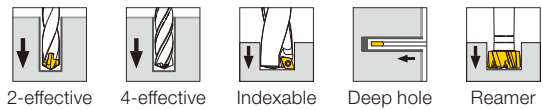

■ Icons for applications of each product

Threading

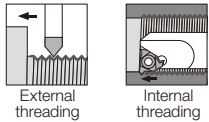

Grooving

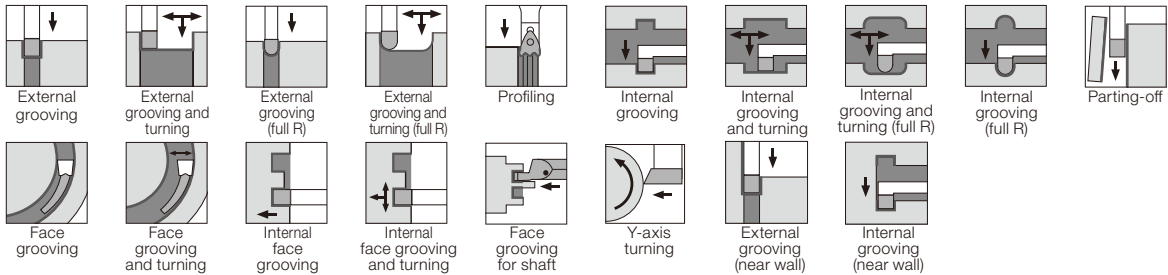

Milling

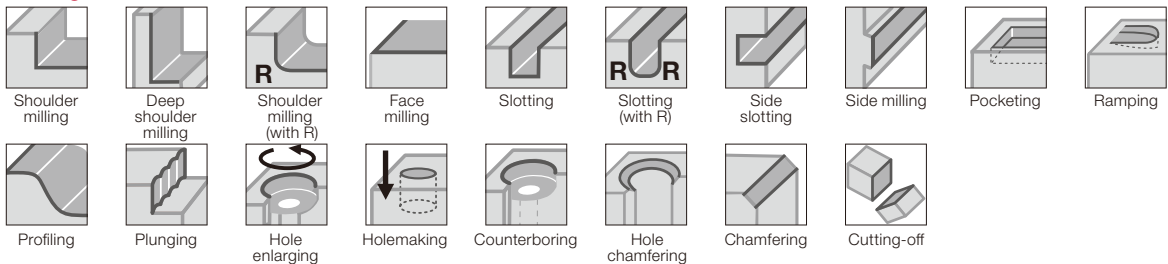

Drilling



About the dimension symbols conforming to ISO13399

■ What is ISO13399?

ISO13399 is an international standard for the purpose of standardizing the electronic data of tools in the world.

■ Switching to the dimension symbols conforming to ISO13399

In this catalog, we use the dimension symbols (properties) conforming to ISO13399 international standard.

Below are the examples of the change.

■ Examples of the change:

	Before	After
Insert		
Turning		
Milling		
Drilling		

ISO13399 standardizes not only the format of 2D and 3D CAD data but also the tool dimension symbols (properties) and reference position information. This allows the tool information to be read and combined into NC programs and CAM software, regardless of any tool maker's data. In addition to General Catalog (paper catalog), we are also updating the symbols in e-catalog (electronic catalog on our website) to the properties conforming to ISO13399. The e-catalog also provides 2D and 3D CAD data in accordance with ISO13399 standard.

■ Insert

New symbol	Old symbol	Description
AN	-	Main cutting edge relief angle
APMX	Max. ap	Maximum depth of cut
AS	A	Side cutting edge relief angle
BW	B	Body width
BS	bs	Side cutting edge (wiper) length
CDX	T max	Maximum groove depth
CW	W	Grooving edge width
D1	ød1	Mounting hole diameter
DCONMS	øDs	Mounting part diameter on the machine
DMIN	øDm	Minimum machining diameter
EPSR	-	Nose angle
GAN	-	Rake angle (insert)
IC	ød	Inscribed circle diameter
INSD	A	Insert diameter (round type)
INSL	B	Insert length
KAPR	κ	Approach angle
LBB	-	Chipbreaker width
LE	A	Effective cutting edge length
LF	L1	Standard length
M	m	Distance from inscribed circle to cutting edge (m dimension)
PDX	t	Thread position (X direction)
PDY	ℓ3	Thread position (Y direction)
PNA	θ	Cutting edge angle
PSIRL	θ	Left-hand front cutting edge angle
PSIRR	θ	Right-hand front cutting edge angle
RE	r	Corner radius
S	T	Thickness
W1	-	Insert width

■ Turning, Grooving

New symbol	Old symbol	Description
B	b	Shank width
BD	øD1, øD2, øD3	Body external diameter
CDX	ar	Maximum groove depth
CND	-	Oil hole diameter
CNT	-	Oil hole plug size
CUTDIA	øDmax	Maximum parting diameter
CW	W	Grooving edge width
CWN	-	Minimum grooving edge width
CWX	-	Maximum grooving edge width
DAXN	øDm	Minimum diameter in face grooving
DAXX	øDmax	Maximum diameter in face grooving
DCONMS	øDs	Mounting part diameter on the machine
DCONWS	øD, ød2	Mounting part diameter on the workpiece
DMIN	øDm	Minimum machining diameter
GAMF	α	Radial rake angle
GAMP	θ	Axial rake angle
H	h	Shank length
HBH	h2	Height of offset on the bottom of head
HBKL	f2	Length of uneven level on the back of head
HBKW	L2	Width of uneven level on the back of head
HBL	L2	Length of offset on the bottom of head
HF	h1	Standard height
KAPR	κ	Approach angle
LB	L	Body length
LF	L1	Standard length
LH	L2	Head length
OAH	h4	Overall height
OAL	L1	Overall length
OAW	L3	Overall width
PSIR	β	Lead angle
WB	-	Body width
WF	f	Standard width
WFS	f2	Standard width (the second corner)

About the dimension symbols conforming to ISO13399

■ Tooling system

New symbol	Old symbol	Description
APMX	Max. ap	Maximum depth of cut
BD	$\varnothing D1, \varnothing D2, \varnothing D3$	Body external diameter
BHTA	α	Neck taper angle (half of nose angle)
BTED	$\varnothing d1$	Taper tip diameter
CRKS	S	Mounting screw size
DBC	$\varnothing d3$	Bolt hole pitch diameter
DCONMS	$\varnothing Ds$	Mounting part diameter on the machine
DCONWS	$\varnothing D, \varnothing d2$	Mounting part diameter on the workpiece
DMIN	$\varnothing Dm$	Minimum machining diameter
GAMF	$\alpha, R.R.$	Radial rake angle
GAMP	$\theta, A.R.$	Axial rake angle
KAPR	κ	Cutting edge angle
LB	L2, L3	Body length
LF	L	Standard length
LPR	L1	Parting length
LS	ℓs	Shank length
LSC	Lmin	Clamp length
LSCX	Lmax	Maximum clamp length
OAH	H4	Overall height
OAL	L	Overall length
OAW	W	Overall width
THID	-	Mounting screw size
WB	W	Body width
WF	f	Standard width

■ Drilling

New symbol	Old symbol	Description
BD	$\varnothing D1, \varnothing D2, \varnothing D3$	Body external diameter
CND	-	Oil hole diameter
CNT	-	Oil hole plug size
CRKS	S	Mounting screw size
DC	$\varnothing Dc$	Machining diameter
DCONMS	$\varnothing Ds$	Mounting part diameter on the machine
DCONWS	$\varnothing D, \varnothing d2$	Mounting part diameter on the workpiece
DSCFMS	$\varnothing D$	Connecting part diameter
KAPR	κ	Cutting edge angle
LCF	ℓ	Flute length
LF	Lf	Standard length (from the drill shoulder)
LPR	-	Parting length (from flange to tip)
LS	ℓs	Shank length
LU	ℓ	Machinable depth
NOF	z	Number of flutes
OAL	L	Overall length (from tip)
PL	PL	Distance from drill tip to shoulder
ZEFP	Z eff	Number of effective cutting edges on periphery

■ Milling

New symbol	Old symbol	Description
APMX	Max. ap	Maximum depth of cut
BD	$\varnothing D1, \varnothing D2, \varnothing D3$	Body external diameter
BHTA	α	Neck taper angle (half of nose angle)
CBDP	ℓ	Mounting hole depth
CDX	Max. ae	Maximum slot width
CHW	k	Chamfer width on the corner
CICT	z	Number of inserts
CRKS	S	Mounting screw size
CW	W	Slotting edge width
CWN	-	Minimum slotting edge width
CWX	-	Maximum slotting edge width
DBC	$\varnothing d3$	Bolt hole pitch diameter
DC	$\varnothing Dc$	Machining diameter
DCONMS	$\varnothing d$	Mounting part diameter on the machine
DCONWS	$\varnothing D, \varnothing d2$	Mounting part diameter on the workpiece
DSCFMS	$\varnothing Db$	Mounting surface diameter on the machine
DCX	$\varnothing Dc1$	Maximum machining diameter
GAMF	R.R.	Radial rake angle
GAMP	A.R.	Axial rake angle
H	T	Width across flat
KAPR	κ	Cutting edge angle
KWW	a	Drive key width
LF	Lf	Standard length
LH	Lf	Neck length
LS	ℓs	Shank length
NOF	z	Number of flutes
OAL	L, L6	Overall length
PDX	t	Thread position (X direction)
PNA	θ	Cutting edge angle
PSIR	β	Lead angle
RMPX	θ	Maximum ramping angle
THUB	T	Hub height (slot mill)
WT	Kg	Weight
ZEFP	Z eff	Number of effective cutting edges on the periphery

Note:

- Symbols unspecified in ISO13399 standard and Tungaloy's original symbols are not included.
- The symbols still under discussion are included. Please note any change or addition may occur.

■ CAD data provided in e-catalog

● 2D data (DXF format file)

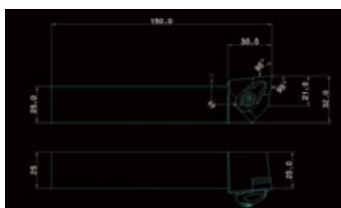

Turning:
Shows the insert with standard corner radius.

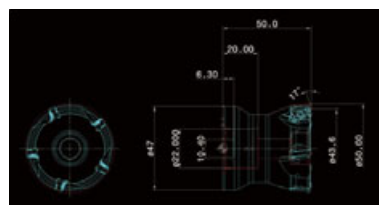

Milling:
Includes actual cutting edge curve (CUT layer) and body cross section (NOCUT layer).

● 3D data Light type (STP format file): Can be used to check tool path and interference.

Turning: Equipped with an insert with a standard corner radius.

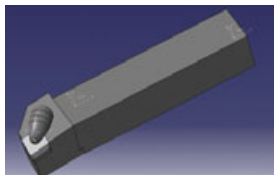

Milling: A rotating body model of an actual cutting edge curve and a body cross section.



● 3D data Detail type (STP format file): Can be used to create a new tool layout chart. (Can be combined with any insert model on a CAD software.)

Turning

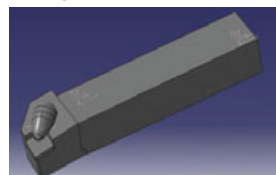

Milling



Drilling Tool



Drilling Tool



2 Effective Drill

J004, J006
J009 -



4 Effective Drill

J004
J057



Indexable Drill

J004
J059 -



Deep Hole Drill

J005
J091 -



Reamer

J005
J164 -

Basic Selection of Drilling Tools

Application ranges of drilling tools

Exchangeable Head Drills & Indexable Drills

2 Effective Drill

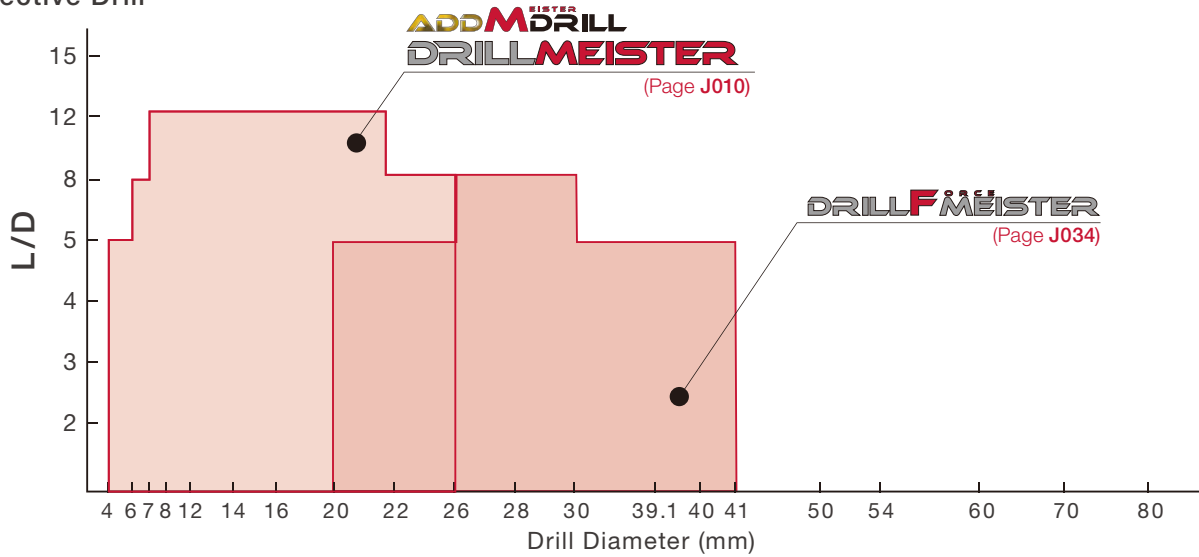

Indexable Drill

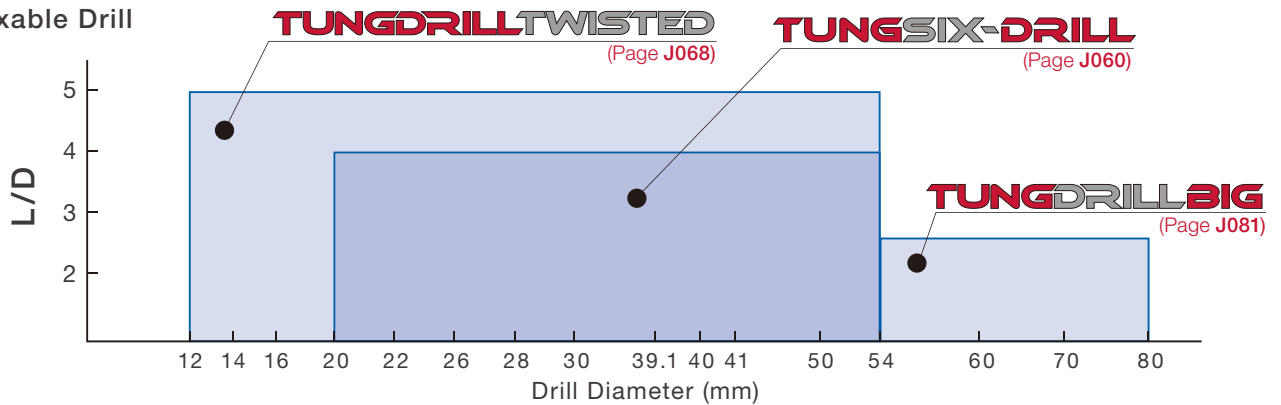

Deep Hole Drill

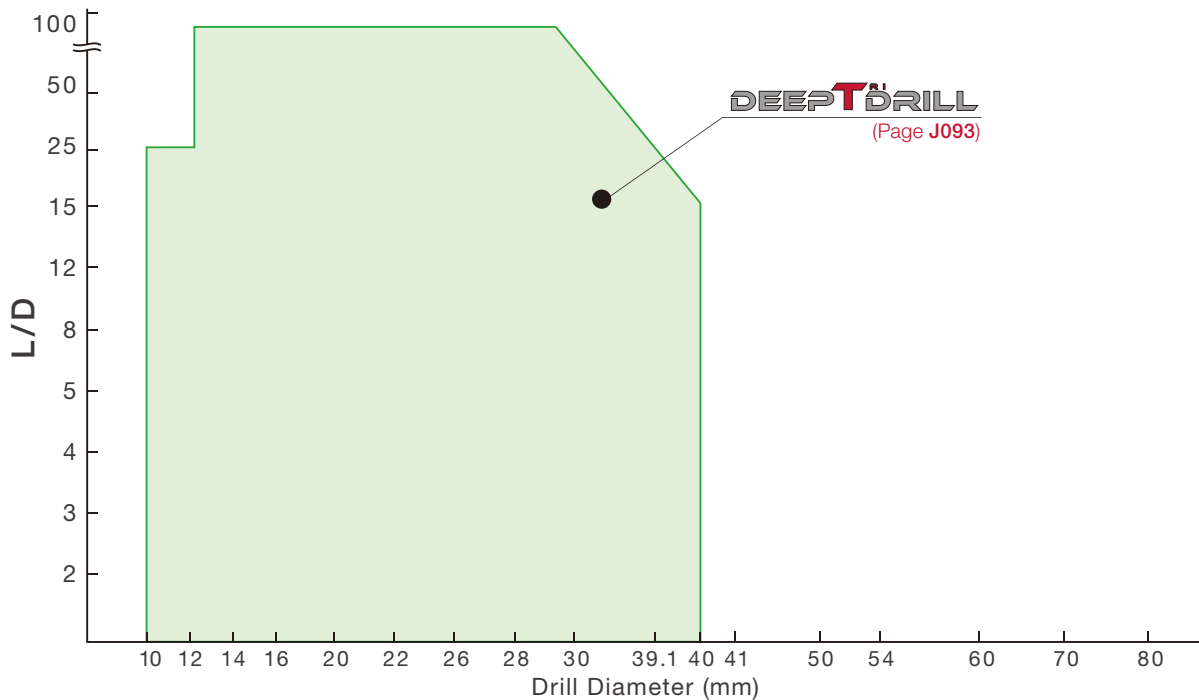

Solid Drills, Brazed Carbide Drills

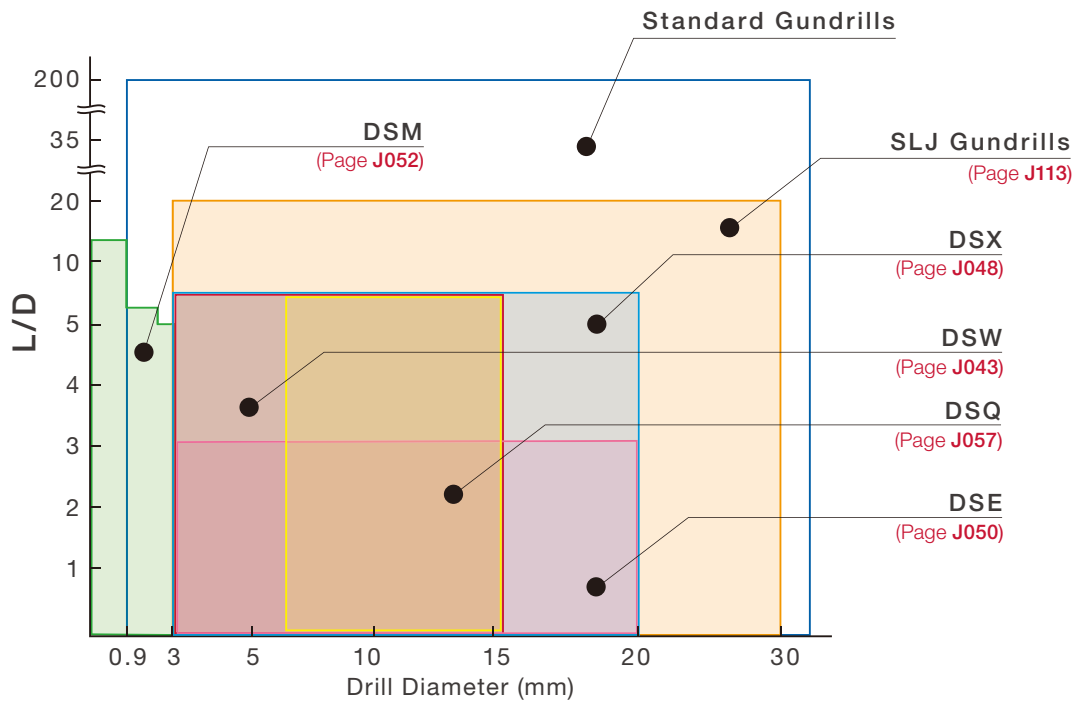

Hole diameter tolerance*

TUNGSIX-DRILL

L/D	Tool diameter	Hole diameter tolerance*
2	ø20 - ø27	+ 0.25 / 0
	ø28 - ø54	+ 0.3 / 0
3	ø20 - ø27	+ 0.25 / 0
	ø28 - ø54	+ 0.3 / 0
4	ø20 - ø27	+ 0.3 / 0
	ø28 - ø54	+ 0.35 / 0

TUNGDRILLTWISTED

L/D	Tool diameter	Hole diameter tolerance*
2	ø12.5 - ø17	+ 0.25 / 0
	ø17.5 - ø54	+ 0.3 / 0
3	ø12.5 - ø17	+ 0.25 / 0
	ø17.5 - ø54	+ 0.3 / 0
4	ø12.5 - ø17	+ 0.4 / 0
	ø17.5 - ø54	+ 0.45 / 0
5	ø12.5 - ø17	+ 0.4 / 0
	ø17.5 - ø54	+ 0.45 / 0

ADDMASTER DRILLMEISTER

L/D	Tool diameter	Hole diameter tolerance*
1.5	ø6 - ø17.9	+ 0.03 / 0
	ø18 - ø25.9	+ 0.035 / 0
2	ø6 - ø16.9	+ 0.04 / 0
3	ø4 - ø17.9	+ 0.04 / 0
	ø18 - ø25.9	+ 0.045 / 0
3.5	ø6 - ø19.9	+ 0.04 / 0
5	ø4 - ø25.9	+ 0.05 / 0
6	ø6 - ø17.9	+ 0.05 / 0
	ø18 - ø19.9	+ 0.055 / 0
8	ø6 - ø17.9	+ 0.05 / 0
	ø18 - ø25.9	+ 0.055 / 0
12	ø8 - ø17.9	+ 0.05 / 0
	ø18 - ø25.9	+ 0.055 / 0

DRILLFMEISTER

L/D	Tool diameter	Hole diameter tolerance*
3	ø20 - ø29.9	+ 0.05 / 0
	ø30 - ø41	+ 0.06 / 0
5	ø20 - ø29.9	+ 0.08 / 0
	ø30 - ø41	+ 0.09 / 0
8	ø26 - ø29.9	+ 0.08 / 0
	ø30 - ø33.9	+ 0.09 / 0

















DEEPTDRILL

L/D	Tool diameter	Hole diameter tolerance*
8	ø33.1 - ø39.1	+ 0.05 / - 0.1
10	ø16 - ø40	+ 0.05 / - 0.1
	ø14 - ø40	+ 0.05 / - 0.1
15	ø12 - ø13.99	+ 0.05 / - 0.11
	ø14 - ø15	+ 0.05 / - 0.1
20	ø12 - ø13.99	+ 0.05 / - 0.11
	ø14 - ø15	+ 0.05 / - 0.1
25	ø10 - ø13.99	+ 0.05 / - 0.11
	ø14 - ø38.1	+ 0.05 / - 0.1
35, 40, 45	ø12 - ø13.99	+ 0.05 / - 0.11
	ø14 - ø15	+ 0.05 / - 0.1

*Just for reference



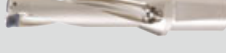



General drilling - Quick Guide

★ : First choice
☆ : Second choice

Tool series	Designation	Appearance	Tool diameter	Effective Cutting edge	L/D	Coolant supply	IT class	Workpiece material					Remark	Page	
								P	M	K	N	S			H
ADD M DRILL	TID		ø4 - ø5.9	2	3 5	Int.	8 - 10	★	★	★	★	★	★	Exchangeable head drill	J010 -
DRILLMEISTER	TID TIDC TIDCF		ø6 - ø25.9	2	1.5 2 3 3.5 5 6 8 12	Int. / Ext.	8 - 10	★	★	★	★	★	★	Exchangeable head drill	J012 -
DRILL F MEISTER	TIS		ø20 - ø41	2	3 5 8	Int.	9 - 10	★	★	★	☆	★	★	Exchangeable head drill	J034 -
SOLID DRILL	DSM DSM-CP		ø0.1 - ø3	2	5 10 15	Ext.	9 - 10	★	★	★	☆	☆	☆	Solid drill	J041 -
	CDS		ø1 - ø9	2	3 - 8	Ext.	9 - 10			★	★			Solid drill	J043
	DSW		ø3 - ø12	2	3 5 8	Int. / Ext.	9 - 10	★	★	★	☆	★	☆	Solid drill	J044 -
	DSX		ø3 - ø20	2	3 5 8	Int.	9 - 10	★	★	★	☆	☆	☆	Solid drill	J049 -
	DSE		ø3 - ø15	2	2 3	Ext.	9 - 10	★	☆	☆	☆	★	☆	Solid Drill	J051
	FDC		ø5 - ø16	2	5 8	Int.	9 - 10			★	★			Solid Drill	J053
	DMX		ø3 - ø16.5	2	2 3	Ext.	9 - 10	★	☆	☆	☆	★	☆	Solid Drill	J054
	DMX-F		ø3 - ø12.5	2	3 5	Ext.	9 - 10			★	★			Solid Drill	J055 -
	FDS		ø11	2	3	Ext.	8 - 10			★	★			Solid Drill	J056
	SOLID 4 FLUTE DRILL	DSQ		ø6 - ø16	4	3 5	Ext.	9 - 10			★				Solid Drill
TUNG SIX-DRILL	TDS		ø20 - ø54	1	2 3 4	Int.	11 - 13	★	★	★	☆	★	★	Indexable drill	J060 -
TUNG DRILL TWISTED	TDX		ø12.5 - ø54	1	2 3 4 5	Int.	11 - 13	★	★	★	☆	★	★	Indexable drill	J068 -
TUNG DRILL BIG	TDS TDX		ø55 - ø80	1	2.5	Int.	11 - 13	★	★	★	☆	★	★	Indexable drill	J081 -

Deep drilling - Quick Guide

★ : First choice
☆ : Second choice

Tool series	Designation	Appearance	Tool diameter	Effective Cutting edge	L/D	Coolant supply	IT class	Workpiece material					Remark	Page	
								P	M	K	N	S			H
DEEPTDRILL	MCTR/TRLG		ø10-ø40	1	8 10 15 20 25 35 40 45 (for machining centers) Length ≤ 1650 mm (for gundrill machines)	Int.	IT10-11	★	☆	★	☆	☆	☆	Indexable drill	J093 -
GUNDRILL	SLJ		ø3-ø12.2	1	Length ≤ 1650 mm (for gundrill machines)	Int.	IT7-8	☆	☆	★	★	☆	☆	Brazed tool	J113
TRI-FINE	FNTR		ø16-ø28	1	-	Int.	IT10	★	★	★	☆	★	★	Indexable drill	J116 -
FINE-BEAM	FNBM		ø25-ø65	1	-	Int.	IT10	★	★	★	☆	★	★	Indexable drill	J121 -
UNIDEX	MBU/UTE/BTU		ø38-ø106.99	1	-	Int.	IT10	★	★	★	☆	☆	☆	Indexable drill	J129 -
Brazed BTA drill	MBU/UTE/BTU		ø8-ø65	1	-	Int.	IT9	★	★	★	☆	☆	☆	Brazed tool	J150 -
HF drill	HF		ø30-ø69	1	6 - 14	Int.	IT10	★	☆	★	☆	★	☆	Indexable drill	J163

Reaming - Quick Guide

★ : First choice
☆ : Second choice

Tool series	Designation	Appearance	Tool diameter	Effective Cutting edge	L/D	Coolant supply	IT class	Workpiece material					Remark	Page	
								P	M	K	N	S			H
REAMMEISTER	TRM		ø11.5-ø32	6, 8	1.5 3 5 8	Int.	IT7	★	★	★	☆	★	★	Indexable drill	J164 -

Grade
Insert
Ext. Toolholder
Int. Toolholder
Threading
Grooving
Miniature tool
Milling cutter
Endmill
Drilling tool
Tooling System
User's Guide
Index











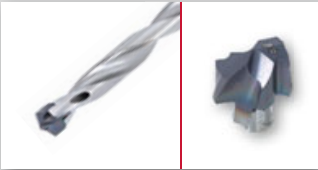











DrillMeister

2 Effective Drill

Exchangeable head drill

	ADDMEISTER DRILL  Exchangeable head drill series $\varnothing 4 \text{ mm} - \varnothing 5.9 \text{ mm} / L/D = 3, 5$	J010 - J025 -
	DRILLMEISTER  Exchangeable head drill series $\varnothing 6 \text{ mm} - \varnothing 25.9 \text{ mm} / L/D = 1.5, 2, 3, 3.5, 5, 6, 8, 12$	J010 J012 - J025 -
	DRILL FORCE MEISTER  Two cutting edges functioned for productivity in large diameter drilling $\varnothing 20 \text{ mm} - \varnothing 41 \text{ mm} / L/D = 3, 5, 8$	J034 -

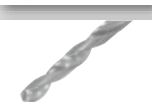
Solid Drill

	SOLIDDRILL High performance solid carbide drill	J041 -
	DSM / DSM-CP $\varnothing 0.1 \text{ mm} - \varnothing 3 \text{ mm} / L/D = 5, 10, 15$	J041 -
	CDS $\varnothing 0.4 \text{ mm} - \varnothing 9 \text{ mm} / L/D = 3 - 8$	J043
	 DSW $\varnothing 3 \text{ mm} - \varnothing 12 \text{ mm} / L/D = 3, 5, 8$	J044 -
	 DSX $\varnothing 3 \text{ mm} - \varnothing 20 \text{ mm} / L/D = 3, 5, 8$	J048 -
	DSE $\varnothing 3 \text{ mm} - \varnothing 15 \text{ mm} / L/D = 2, 3$	J051 -
	 FDC $\varnothing 5 \text{ mm} - \varnothing 16 \text{ mm} / L/D = 5, 8$	J053
	DMX / DMX-F $\varnothing 3 \text{ mm} - \varnothing 16.5 \text{ mm} / L/D = 2, 3, 5$	J055 -
	FDS $\varnothing 11 \text{ mm} / L/D = 3$	J056



Exchangeable head drills for unparalleled tool life and machining performance

- Helical margin to prevent chip adhesion between the body and the hole during machining
- Tool body made from highest grade of steel with superior hardness for high wear resistance
- Wide variety of geometries for every drilling application
- Advanced grade options ensure stable, long tool life
- Internal coolant channels supply efficient cooling and lubrication during the drilling process

ADD M^{EISTER} DRILL
Tool diameter: $\varnothing 4$ - $\varnothing 5.9$ mm

DRILLMEISTER
Tool diameter: $\varnothing 6$ - $\varnothing 25.9$ mm

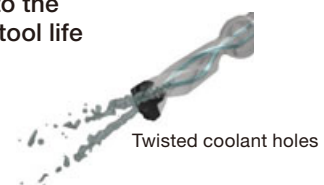

Quick and precise head changing with advanced self-clamping system

- Drilling head pocket designed to withstand high machining cutting conditions
- Allows easy and fast head indexing, minimizing machine downtime

Reference pages: **J011 - J033**,
Technical reference → **L079**

Exchangeable head drill, L/D = 3, Cylindrical shank

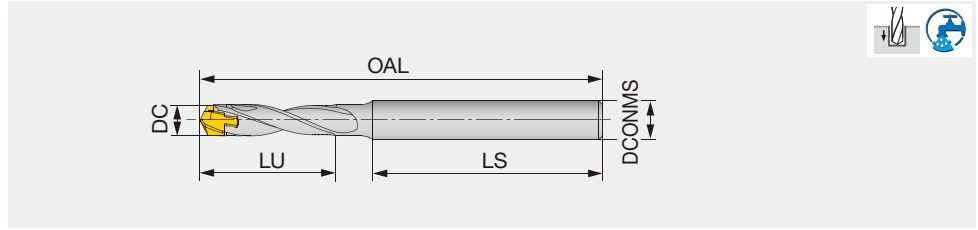

Designation	DC	DCONMS	LU	LS	OAL		Pocket size	Head
					DMP	DMC		
TID040R06-3	4 - 4.4	6	13	35	57.7	58.1	4	DM*040 - DM*044
TID045R06-3	4.5 - 4.9	6	14	35	59.7	59.9	4.5	DM*045 - DM*049
TID050R06-3	5 - 5.4	6	16	35	61.4	61.8	5	DM*050 - DM*054
TID055R06-3	5.5 - 5.9	6	17	35	64	64.3	5.5	DM*055 - DM*059

Tool diameter	Hole diameter tolerance*
ø4 - ø5.9	+0.04 / 0

*Just for reference

- An overall length (OAL) differs based on each head geometry.
- When using the drill at a higher feed rate, make sure to provide an axial support by placing the overhang adjusting screw at the drill shank end in the tool holder. This will prevent high thrust force from pushing the drill back into the holder during drilling.
- When axially adjusting the shank inside the holder to obtain a required drill overhang, make sure the shank length remaining inside the holder does not come short of the minimum clamping length (LSCN) specified by the holder supplier.

TID-R L/D=5

Exchangeable head drill, L/D = 5, Cylindrical shank

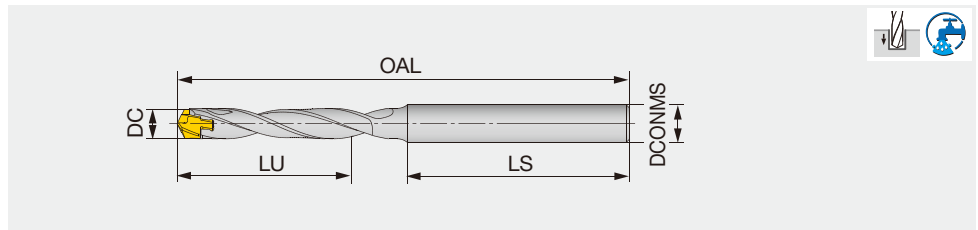

Designation	DC	DCONMS	LU	LS	OAL		Pocket size	Head
					DMP	DMC		
TID040R06-5	4 - 4.4	6	21	35	65.7	66.1	4	DM*040 - DM*044
TID045R06-5	4.5 - 4.9	6	23	35	68.7	68.9	4.5	DM*045 - DM*049
TID050R06-5	5 - 5.4	6	26	35	71.3	71.6	5	DM*050 - DM*054
TID055R06-5	5.5 - 5.9	6	28	35	74.2	74.5	5.5	DM*055 - DM*059

Tool diameter	Hole diameter tolerance*
ø4 - ø5.9	+0.05 / 0

*Just for reference

- An overall length (OAL) differs based on each head geometry.
- When using the drill at a higher feed rate, make sure to provide an axial support by placing the overhang adjusting screw at the drill shank end in the tool holder. This will prevent high thrust force from pushing the drill back into the holder during drilling.
- When axially adjusting the shank inside the holder to obtain a required drill overhang, make sure the shank length remaining inside the holder does not come short of the minimum clamping length (LSCN) specified by the holder supplier.

SPARE PARTS

Designation	Clamping key
TID040..., TID045...	K-TID4-4.99
TID050..., TID055...	K-TID5-5.99



DRILLMEISTER

TID L/D=1.5

Exchangeable head drill, L/D = 1.5, flange type

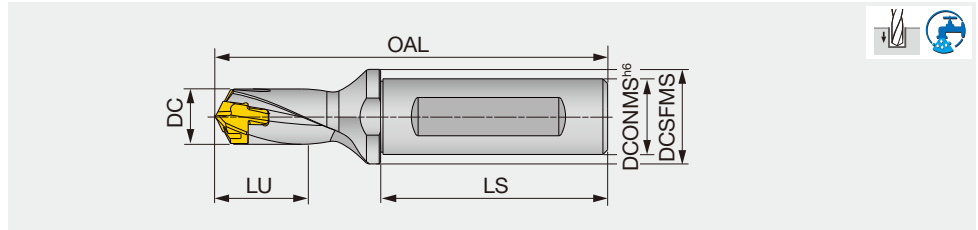

Designation	DC	DCONMS	DCSFMS	LU	LS	OAL			Pocket size	Head
						DMP/H/N	DMC	DMF		
TID060F12-1.5	6 - 6.4	12	16	10	45	67.9	68	67	6	DM*060 - DM*064
TID065F12-1.5	6.5 - 6.9	12	16	11	45	68.9	69.1	68	6.5	DM*065 - DM*069
TID070F12-1.5	7 - 7.4	12	16	12	45	70	70.4	69.1	7	DM*070 - DM*074
TID075F12-1.5	7.5 - 7.9	12	16	13	45	70.7	71.2	69.8	7	DM*075 - DM*079
TID080F12-1.5	8 - 8.9	12	16	14	45	72.3	72.4	71.4	8	DM*080 - DM*089
TID090F12-1.5	9 - 9.9	12	16	16	45	74.2	74.3	73.1	9	DM*090 - DM*099
TID100F16-1.5	10 - 10.9	16	20	17	48	79.1	79.7	77.7	10	DM*100 - DM*109
TID110F16-1.5	11 - 11.9	16	20	19	48	81	81.6	79.4	11	DM*110 - DM*119
TID120F16-1.5	12 - 12.9	16	20	20	48	82.8	83.4	81.2	12	DM*120 - DM*129
TID130F16-1.5	13 - 13.9	16	20	22	48	84.9	85.7	83	13	DM*130 - DM*139
TID140F16-1.5	14 - 14.9	16	20	24	48	89	89.8	87	14	DM*140 - DM*149
TID150F20-1.5	15 - 15.9	20	25	26	50	96	96.9	93.9	15	DM*150 - DM*159
TID160F20-1.5	16 - 16.9	20	25	27	50	99.1	100.1	96.8	16	DM*160 - DM*169
TID170F20-1.5	17 - 17.9	20	25	29	50	102.2	103.2	99.7	17	DM*170 - DM*179
TID180F25-1.5	18 - 18.9	25	32	30	56	111.3	112.4	108.5	18	DM*180 - DM*189
TID190F25-1.5	19 - 19.9	25	32	33	56	114.3	115.4	111.3	19	DM*190 - DM*199
TID200F25-1.5	20 - 20.9	25	32	34	56	117.4	118.6	115.1	20	DM*200 - DM*209
TID210F25-1.5	21 - 21.9	25	32	36	56	120.5	121.7	118	21	DM*210 - DM*219
TID220F25-1.5	22 - 22.9	25	32	37	56	123.6	124.8	120.9	22	DM*220 - DM*229
TID230F32-1.5	23 - 23.9	32	42	39	60	130.6	132	127.8	23	DM*230 - DM*239
TID240F32-1.5	24 - 24.9	32	42	40	60	133.7	135.1	130.7	24	DM*240 - DM*249
TID250F32-1.5	25 - 25.9	32	42	43	60	136.8	138.3	133.7	25	DM*250 - DM*259

Tool diameter	Hole diameter tolerance*
ø6 - ø17.9	+0.03 / 0
ø18 - ø25.9	+0.035 / 0

- An overall length (OAL) differs based on each head geometry.
 - For drill diameters from ø8 - ø9.9 mm, the drill shoulder to shank bottom distance when a DMC drill head is mounted is 0.3 mm shorter when compared with a DMP head of the equivalent sizes. The distances are the same for the DMC and DMP drill heads in other diameters than the above.

*Just for reference

SPARE PARTS



Designation	Clamping key
TID060... - TID090...	K-TID6-9.99
TID100... - TID190...	K-TID10-19.99
TID200... - TID250...	K-TID20-26.99

Reference pages: Head → **J025 - J032**
 Standard cutting conditions → **J033**

TID-R-2E L/D=2

Exchangeable head drill, L/D = 2, Cylindrical shank, for external coolant supply

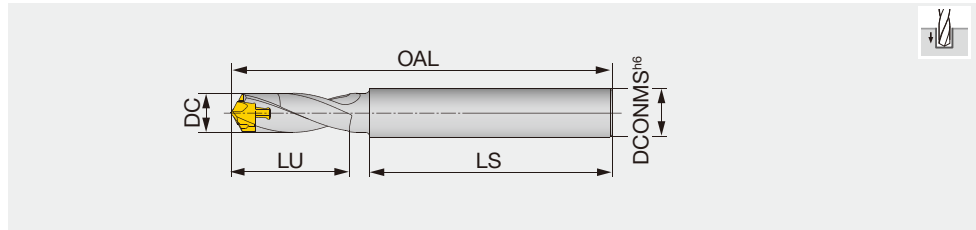

Designation	DC	DCONMS	LU	LS	OAL			Pocket size	Head
					DMP/H/N	DMC	DMF		
TID060R8-2E	6 - 6.4	8	12	45	66.1	66.2	65.2	6	DM*060 - DM*064
TID065R8-2E	6.5 - 6.9	8	13	45	67.2	67.3	66.3	6.5	DM*065 - DM*069
TID070R8-2E	7 - 7.4	8	13	45	68	68.4	67.1	7	DM*070 - DM*074
TID075R8-2E	7.5 - 7.9	8	14	45	69	69.4	68.1	7	DM*075 - DM*079
TID080R10-2E	8 - 8.9	10	15	50	75.2	75.3	74.3	8	DM*080 - DM*089
TID090R10-2E	9 - 9.9	10	17	50	77.4	77.5	76.3	9	DM*090 - DM*099
TID100R12-2E	10 - 10.9	12	22	60	94.3	94.9	92.9	10	DM*100 - DM*109
TID110R12-2E	11 - 11.9	12	24	60	96.5	97.1	94.9	11	DM*110 - DM*119
TID120R14-2E	12 - 12.9	14	26	65	103.6	104.2	102	12	DM*120 - DM*129
TID130R14-2E	13 - 13.9	14	27	65	108.8	109.6	106.9	13	DM*130 - DM*139
TID140R16-2E	14 - 14.9	16	29	70	115	115.8	113	14	DM*140 - DM*149
TID150R16-2E	15 - 15.9	16	32	70	118	118.9	115.9	15	DM*150 - DM*159
TID160R18-2E	16 - 16.9	18	33	70	122.2	123.2	119.9	16	DM*160 - DM*169

Tool diameter	Hole diameter tolerance*
ø6 - ø16.9	+0.04 / 0

*Just for reference

- An overall length (OAL) differs based on each head geometry.
- When using the drill at a higher feed rate, make sure to provide an axial support by placing the overhang adjusting screw at the drill shank end in the tool holder. This will prevent high thrust force from pushing the drill back into the holder during drilling.
- When axially adjusting the shank inside the holder to obtain a required drill overhang, make sure the shank length remaining inside the holder does not come short of the minimum clamping length (LSCN) specified by the holder supplier.
- For drill diameters from ø8 - ø9.9 mm, the drill shoulder to shank bottom distance when a DMC drill head is mounted is 0.3 mm shorter when compared with a DMP head of the equivalent sizes. The distances are the same for the DMC and DMP drill heads in other diameters than the above.

SPARE PARTS

Designation	Clamping key
TID060... - TID095...	K-TID6-9.99
TID100... - TID160...	K-TID10-19.99

Reference pages: Head → **J025 - J032**
Standard cutting conditions → **J033**



DRILLMEISTER

TID L/D=3

Exchangeable head drill, L/D = 3, flange type

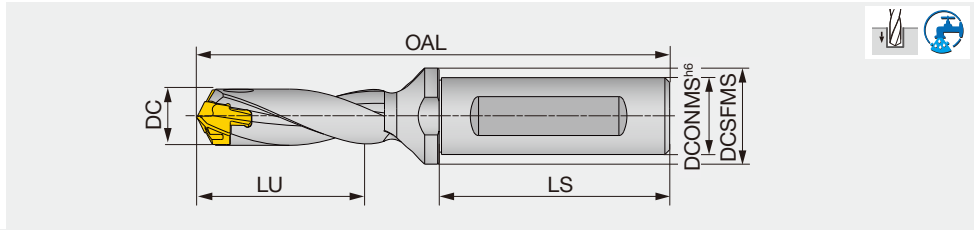

Designation	DC	DCONMS	DCSFMS	LU	LS	OAL			Pocket size	Head
						DMP/H/N	DMC	DMF		
TID060F12-3	6 - 6.4	12	16	19	45	76.9	77	76	6	DM*060 - DM*064
TID065F12-3	6.5 - 6.9	12	16	21	45	78.7	78.8	77.8	6.5	DM*065 - DM*069
TID070F12-3	7 - 7.4	12	16	22	45	80.5	80.9	79.6	7	DM*070 - DM*074
TID075F12-3	7.5 - 7.9	12	16	24	45	82	82.4	81.1	7	DM*075 - DM*079
TID080F12-3	8 - 8.4	12	16	26	45	84.3	84.4	83.4	8	DM*080 - DM*084
TID085F12-3	8.5 - 8.9	12	16	28	45	85.8	85.9	84.9	8	DM*085 - DM*089
TID090F12-3	9 - 9.4	12	16	29	45	87.7	87.8	86.6	9	DM*090 - DM*094
TID095F12-3	9.5 - 9.9	12	16	31	45	89.2	89.3	88.1	9	DM*095 - DM*099
TID100F16-3	10 - 10.4	16	20	32	48	94.1	94.7	92.7	10	DM*100 - DM*104
TID105F16-3	10.5 - 10.9	16	20	34	48	95.6	96.2	94.2	10	DM*105 - DM*109
TID110F16-3	11 - 11.4	16	20	35	48	97.5	98.1	95.9	11	DM*110 - DM*114
TID115F16-3	11.5 - 11.9	16	20	37	48	99	99.6	97.4	11	DM*115 - DM*119
TID120F16-3	12 - 12.4	16	20	38	48	100.8	101.4	99.2	12	DM*120 - DM*124
TID125F16-3	12.5 - 12.9	16	20	39	48	102.3	102.9	100.7	12	DM*125 - DM*129
TID130F16-3	13 - 13.4	16	20	41	48	104.4	105.2	102.5	13	DM*130 - DM*134
TID135F16-3	13.5 - 13.9	16	20	44	48	105.9	106.7	104	13	DM*135 - DM*139
TID140F16-3	14 - 14.4	16	20	45	48	110	110.8	108	14	DM*140 - DM*144
TID145F16-3	14.5 - 14.9	16	20	47	48	111.5	112.3	109.5	14	DM*145 - DM*149
TID150F20-3	15 - 15.9	20	25	48	50	118.5	119.4	116.4	15	DM*150 - DM*159
TID160F20-3	16 - 16.9	20	25	51	50	123.1	124.1	120.8	16	DM*160 - DM*169
TID170F20-3	17 - 17.9	20	25	54	50	127.7	128.7	125.2	17	DM*170 - DM*179
TID180F25-3	18 - 18.9	25	32	57	56	138.3	139.4	135.5	18	DM*180 - DM*189
TID190F25-3	19 - 19.9	25	32	61	56	142.8	143.9	139.8	19	DM*190 - DM*199
TID200F25-3	20 - 20.9	25	32	64	56	147.4	148.6	145.1	20	DM*200 - DM*209
TID210F25-3	21 - 21.9	25	32	67	56	152	153.2	149.5	21	DM*210 - DM*219
TID220F25-3	22 - 22.9	25	32	70	56	156.6	157.8	153.9	22	DM*220 - DM*229
TID230F32-3	23 - 23.9	32	42	73	60	165.1	166.5	162.3	23	DM*230 - DM*239
TID240F32-3	24 - 24.9	32	42	76	60	169.7	171.1	166.7	24	DM*240 - DM*249
TID250F32-3	25 - 25.9	32	42	80	60	174.3	175.8	171.2	25	DM*250 - DM*259

Tool diameter	Hole diameter tolerance*
ø6 - ø17.9	+0.04 / 0
ø18 - ø25.9	+0.045 / 0

- An overall length (OAL) differs based on each head geometry.
 - For drill diameters from ø8 - ø9.9 mm, the drill shoulder to shank bottom distance when a DMC drill head is mounted is 0.3 mm shorter when compared with a DMP head of the equivalent sizes. The distances are the same for the DMC and DMP drill heads in other diameters than the above.

*Just for reference

SPARE PARTS



Designation	Clamping key
TID060... - TID095...	K-TID6-9.99
TID100... - TID190...	K-TID10-19.99
TID200... - TID250...	K-TID20-26.99

Reference pages: Head → **J025 - J032**
 Standard cutting conditions → **J033**

TIDC L/D=3

Exchangeable head drill, L/D = 3, Cylindrical shank, for chamfering adapter

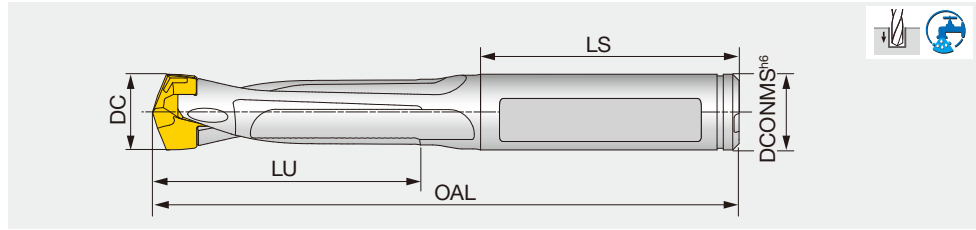

Designation	DC	DCONMS	LU	LS	OAL			Pocket size	Head
					DMP/H/N	DMC	DMF		
TIDC075C8-3	7.5 - 7.9	8	23	36	70.1	70.6	69.2	7	DM*075 - DM*079
TIDC080C8-3	8 - 8.4	8	24	36	70.6	70.8	69.7	8	DM*080 - DM*084
TIDC085C9-3	8.5 - 8.9	9	26	36	72.8	73	71.9	8	DM*085 - DM*089
TIDC090C9-3	9 - 9.4	9	27	36	74.7	74.9	73.7	9	DM*090 - DM*094
TIDC095C10-3	9.5 - 9.9	10	29	36	76.2	76.4	75.2	9	DM*095 - DM*099
TIDC100C10-3	10 - 10.4	10	32	41	86.1	86.7	84.8	10	DM*100 - DM*104
TIDC105C11-3	10.5 - 10.9	11	33	41	87.6	88.2	86.3	10	DM*105 - DM*109
TIDC110C11-3	11 - 11.4	11	35	41	89.5	90.2	88	11	DM*110 - DM*114
TIDC115C12-3	11.5 - 11.9	12	37	41	91	91.7	89.5	11	DM*115 - DM*119
TIDC120C12-3	12 - 12.4	12	38	41	92.8	93.4	91.2	12	DM*120 - DM*124
TIDC125C13-3	12.5 - 12.9	13	40	46	98.3	98.9	96.7	12	DM*125 - DM*129
TIDC130C13-3	13 - 13.4	13	41	47	102.4	103.2	100.5	13	DM*130 - DM*134
TIDC135C14-3	13.5 - 13.9	14	43	43	99.9	100.7	98	13	DM*135 - DM*139
TIDC140C14-3	14 - 14.4	14	45	44	103	103.8	101	14	DM*140 - DM*144
TIDC145C15-3	14.5 - 14.9	15	46	45	105.5	106.3	103.5	14	DM*145 - DM*149
TIDC150C15-3	15 - 15.9	15	48	45	107.5	108.4	105.4	15	DM*150 - DM*159
TIDC160C16-3	16 - 16.9	16	51	48	117.5	118.5	115.2	16	DM*160 - DM*169
TIDC170C17-3	17 - 17.9	17	54	48	119.7	120.7	117.2	17	DM*170 - DM*179
TIDC180C18-3	18 - 18.9	18	57	48	123.3	124.4	120.5	18	DM*180 - DM*189
TIDC190C19-3	19 - 19.9	19	61	54	132.4	133.5	129.4	19	DM*190 - DM*199

Tool diameter	Hole diameter tolerance*
ø7.5 - ø17.9	+0.04 / 0
ø18 - ø19.9	+0.045 / 0

*Just for reference

- An overall length (OAL) differs based on each head geometry.
- When using the drill at a higher feed rate, make sure to provide an axial support by placing the overhang adjusting screw at the drill shank end in the tool holder. This will prevent high thrust force from pushing the drill back into the holder during drilling.
- For drill diameters from ø8 - ø9.9 mm, the drill shoulder to shank bottom distance when a DMC drill head is mounted is 0.3 mm shorter when compared with a DMP head of the equivalent sizes. The distances are the same for the DMC and DMP drill heads in other diameters than the above.
- When axially adjusting the shank inside the holder to obtain a required drill overhang, make sure the shank length remaining inside the holder does not come short of the minimum clamping length (LSCN) specified by the holder supplier.

SPARE PARTS

Designation	Clamping key
TIDC075... - TIDC099...	K-TID6-9.99
TIDC100... - TIDC190...	K-TID10-19.99

Reference pages: Head → **J025 - J032**
Standard cutting conditions → **J033**

DRILLMEISTER

TID-R L/D=3.5

Exchangeable head drill, L/D = 3.5, Cylindrical shank

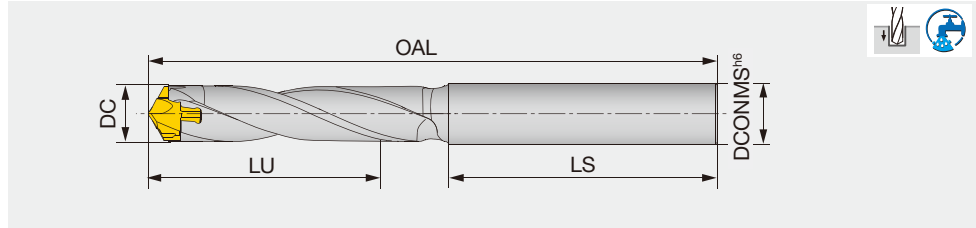

Designation	DC	DCONMS	LU	LS	OAL			Pocket size	Head
					DMP/H/N	DMC	DMF		
TID060R8-3.5	6 - 6.4	8	21	45	75.6	75.8	74.8	6	DM*060 - DM*064
TID065R8-3.5	6.5 - 6.9	8	23	45	77.5	77.6	76.6	6.5	DM*065 - DM*069
TID070R8-3.5	7 - 7.4	8	25	45	79.1	79.5	78.2	7	DM*070 - DM*074
TID075R8-3.5	7.5 - 7.9	8	26	45	80.8	81.3	80	7	DM*075 - DM*079
TID080R10-3.5	8 - 8.4	10	28	50	87.8	87.9	86.9	8	DM*080 - DM*084
TID085R10-3.5	8.5 - 8.9	10	30	50	89.5	89.7	88.6	8	DM*085 - DM*089
TID090R10-3.5	9 - 9.4	10	32	50	91.4	91.6	90.4	9	DM*090 - DM*094
TID095R10-3.5	9.5 - 9.9	10	33	50	93.2	93.3	92.1	9	DM*095 - DM*099
TID100R12-3.5	10 - 10.4	12	42	60	114	114.7	112.7	10	DM*100 - DM*104
TID105R12-3.5	10.5 - 10.9	12	44	60	115.7	116.3	114.4	10	DM*105 - DM*109
TID110R12-3.5	11 - 11.4	12	46	65	123.1	123.8	121.6	11	DM*110 - DM*114
TID115R12-3.5	11.5 - 11.9	12	48	65	124.8	125.4	123.2	11	DM*115 - DM*119
TID120R14-3.5	12 - 12.4	14	50	65	127.2	127.8	125.6	12	DM*120 - DM*124
TID125R14-3.5	12.5 - 12.9	14	52	65	128.8	129.5	127.3	12	DM*125 - DM*129
TID130R14-3.5	13 - 13.4	14	54	65	132.7	133.5	130.9	13	DM*130 - DM*134
TID135R14-3.5	13.5 - 13.9	14	56	65	134.4	135.2	132.5	13	DM*135 - DM*139
TID140R16-3.5	14 - 14.4	16	58	70	142.2	143	140.2	14	DM*140 - DM*144
TID145R16-3.5	14.5 - 14.9	16	60	70	143.8	144.7	141.9	14	DM*145 - DM*149
TID150R16-3.5	15 - 15.9	16	64	70	148.4	149.4	146.3	15	DM*150 - DM*159
TID160R18-3.5	16 - 16.9	18	68	70	153.9	154.9	151.7	16	DM*160 - DM*169
TID170R18-3.5	17 - 17.9	18	72	70	158.5	159.4	155.9	17	DM*170 - DM*179
TID180R20-3.5	18 - 18.9	20	76	70	164	165.1	161.2	18	DM*180 - DM*189
TID190R20-3.5	19 - 19.9	20	80	70	168.4	169.5	165.4	19	DM*190 - DM*199

Tool diameter	Hole diameter tolerance*
ø6 - ø19.9	+0.04 / 0

*Just for reference

- An overall length (OAL) differs based on each head geometry.
- When using the drill at a higher feed rate, make sure to provide an axial support by placing the overhang adjusting screw at the drill shank end in the tool holder. This will prevent high thrust force from pushing the drill back into the holder during drilling.
- When axially adjusting the shank inside the holder to obtain a required drill overhang, make sure the shank length remaining inside the holder does not come short of the minimum clamping length (LSCN) specified by the holder supplier.
- For drill diameters from ø8 - ø9.9 mm, the drill shoulder to shank bottom distance when a DMC drill head is mounted is 0.3 mm shorter when compared with a DMP head of the equivalent sizes. The distances are the same for the DMC and DMP drill heads in other diameters than the above.

SPARE PARTS



Designation	Clamping key
TID060... - TID095...	K-TID6-9.99
TID100... - TID190...	K-TID10-19.99

Reference pages: Head → **J025 - J032**
Standard cutting conditions → **J033**

TID L/D=5

Exchangeable head drill, L/D = 5, flange type

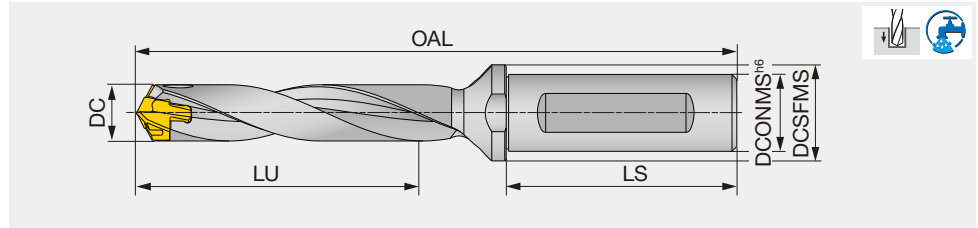

Designation	DC	DCONMS	DCSFMS	LU	LS	OAL			Pocket size	Head
						DMP/H/N	DMC	DMF		
TID060F12-5	6 - 6.4	12	16	31	45	88.9	89	88	6	DM*060 - DM*064
TID065F12-5	6.5 - 6.9	12	16	34	45	91.7	91.8	90.8	6.5	DM*065 - DM*069
TID070F12-5	7 - 7.4	12	16	36	45	94.5	94.9	93.6	7	DM*070 - DM*074
TID075F12-5	7.5 - 7.9	12	16	39	45	97	97.4	96.1	7	DM*075 - DM*079
TID080F12-5	8 - 8.4	12	16	42	45	100.3	100.4	99.4	8	DM*080 - DM*084
TID085F12-5	8.5 - 8.9	12	16	45	45	102.8	102.9	101.9	8	DM*085 - DM*089
TID090F12-5	9 - 9.4	12	16	47	45	105.7	105.8	104.6	9	DM*090 - DM*094
TID095F12-5	9.5 - 9.9	12	16	50	45	108.2	108.3	107.1	9	DM*095 - DM*099
TID100F16-5	10 - 10.4	16	20	52	48	114.1	114.7	112.7	10	DM*100 - DM*104
TID105F16-5	10.5 - 10.9	16	20	55	48	116.6	117.2	115.2	10	DM*105 - DM*109
TID110F16-5	11 - 11.4	16	20	57	48	119.5	120.1	117.9	11	DM*110 - DM*114
TID115F16-5	11.5 - 11.9	16	20	60	48	122	122.6	120.4	11	DM*115 - DM*119
TID120F16-5	12 - 12.4	16	20	62	48	124.8	125.4	123.2	12	DM*120 - DM*124
TID125F16-5	12.5 - 12.9	16	20	64	48	127.3	127.9	125.7	12	DM*125 - DM*129
TID130F16-5	13 - 13.4	16	20	67	48	130.4	131.2	128.5	13	DM*130 - DM*134
TID135F16-5	13.5 - 13.9	16	20	71	48	132.9	133.7	131	13	DM*135 - DM*139
TID140F16-5	14 - 14.4	16	20	73	48	138	138.8	136	14	DM*140 - DM*144
TID145F16-5	14.5 - 14.9	16	20	76	48	140.5	141.3	138.5	14	DM*145 - DM*149
TID150F20-5	15 - 15.9	20	25	78	50	148.5	149.4	146.4	15	DM*150 - DM*159
TID160F20-5	16 - 16.9	20	25	83	50	155.1	156.1	152.8	16	DM*160 - DM*169
TID170F20-5	17 - 17.9	20	25	88	50	161.7	162.7	159.2	17	DM*170 - DM*179
TID180F25-5	18 - 18.9	25	32	93	56	174.3	175.4	171.5	18	DM*180 - DM*189
TID190F25-5	19 - 19.9	25	32	99	56	180.8	181.9	177.8	19	DM*190 - DM*199
TID200F25-5	20 - 20.9	25	32	104	56	187.6	188.8	185.3	20	DM*200 - DM*209
TID210F25-5	21 - 21.9	25	32	109	56	194.2	195.4	191.8	21	DM*210 - DM*219
TID220F25-5	22 - 22.9	25	32	114	56	200.8	202.1	198.1	22	DM*220 - DM*229
TID230F32-5	23 - 23.9	32	42	119	60	211.3	212.7	208.5	23	DM*230 - DM*239
TID240F32-5	24 - 24.9	32	42	124	60	217.9	219.3	214.9	24	DM*240 - DM*249
TID250F32-5	25 - 25.9	32	42	130	60	224.5	226	221.4	25	DM*250 - DM*259

Tool diameter	Hole diameter tolerance*
ø6 - ø25.9	+0.05 / 0

- An overall length (OAL) differs based on each head geometry.
 - For drill diameters from ø8 - ø9.9 mm, the drill shoulder to shank bottom distance when a DMC drill head is mounted is 0.3 mm shorter when compared with a DMP head of the equivalent sizes. The distances are the same for the DMC and DMP drill heads in other diameters than the above.

*Just for reference

SPARE PARTS



Designation	Clamping key
TID060... - TID095...	K-TID6-9.99
TID100... - TID190...	K-TID10-19.99
TID200... - TID250...	K-TID20-26.99

Reference pages: Head → **J025 - J032**
 Standard cutting conditions → **J033**

DRILLMEISTER

TIDC L/D=5

Exchangeable head drill, L/D = 5, Cylindrical shank, for chamfering adapter

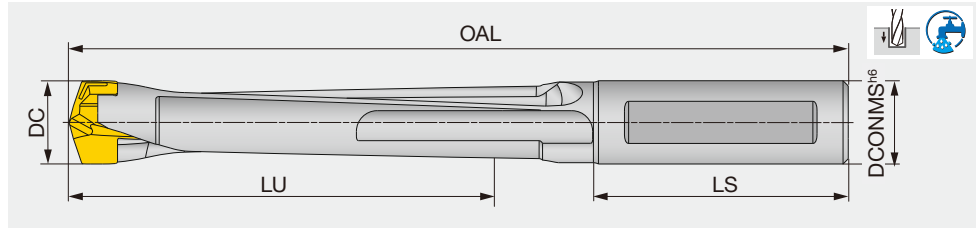

Designation	DC	DCONMS	LU	LS	OAL			Pocket size	Head
					DMP/H/N	DMC	DMF		
TIDC075C8-5	7.5 - 7.9	8	38	36	85.1	85.6	84.2	7	DM*075 - DM*079
TIDC080C8-5	8 - 8.4	8	40	36	92.3	92.5	91.4	8	DM*080 - DM*084
TIDC085C9-5	8.5 - 8.9	9	43	36	89.8	90	88.9	8	DM*085 - DM*089
TIDC090C9-5	9 - 9.4	9	45	36	92.7	92.9	91.7	9	DM*090 - DM*094
TIDC095C10-5	9.5 - 9.9	10	48	36	95.2	95.4	94.2	9	DM*095 - DM*099
TIDC100C10-5	10 - 10.4	10	52	41	106.1	106.7	104.8	10	DM*100 - DM*104
TIDC105C11-5	10.5 - 10.9	11	54	41	108.6	109.2	107.3	10	DM*105 - DM*109
TIDC110C11-5	11 - 11.4	11	57	41	111.5	112.2	110	11	DM*110 - DM*114
TIDC115C12-5	11.5 - 11.9	12	60	41	114	114.7	112.5	11	DM*115 - DM*119
TIDC120C12-5	12 - 12.4	12	62	41	116.8	117.4	115.2	12	DM*120 - DM*124
TIDC125C13-5	12.5 - 12.9	13	65	46	124.3	124.9	122.7	12	DM*125 - DM*129
TIDC130C13-5	13 - 13.4	13	67	47	128.4	129.2	126.5	13	DM*130 - DM*134
TIDC135C14-5	13.5 - 13.9	14	70	43	126.9	127.7	125	13	DM*135 - DM*139
TIDC140C14-5	14 - 14.4	14	73	44	131	131.8	129	14	DM*140 - DM*144
TIDC145C15-5	14.5 - 14.9	15	75	45	134.5	135.3	132.5	14	DM*145 - DM*149
TIDC150C15-5	15 - 15.9	15	78	45	137.5	138.4	135.4	15	DM*150 - DM*159
TIDC160C16-5	16 - 16.9	16	83	48	149.5	150.5	147.2	16	DM*160 - DM*169
TIDC170C17-5	17 - 17.9	17	88	48	153.7	154.7	151.2	17	DM*170 - DM*179
TIDC180C18-5	18 - 18.9	18	93	48	159.3	160.4	156.5	18	DM*180 - DM*189
TIDC190C19-5	19 - 19.9	19	99	54	170.4	171.5	167.4	19	DM*190 - DM*199

Tool diameter	Hole diameter tolerance*	
ø7.5 - ø19.9	+0.05 / 0	

*Just for reference

- An overall length (OAL) differs based on each head geometry.
- When using the drill at a higher feed rate, make sure to provide an axial support by placing the overhang adjusting screw at the drill shank end in the tool holder. This will prevent high thrust force from pushing the drill back into the holder during drilling.
- For drill diameters from ø8 - ø9.9 mm, the drill shoulder to shank bottom distance when a DMC drill head is mounted is 0.3 mm shorter when compared with a DMP head of the equivalent sizes. The distances are the same for the DMC and DMP drill heads in other diameters than the above.
- When axially adjusting the shank inside the holder to obtain a required drill overhang, make sure the shank length remaining inside the holder does not come short of the minimum clamping length (LSCN) specified by the holder supplier.

SPARE PARTS

Designation	Clamping key
TIDC075... - TIDC099...	K-TID6-9.99
TIDC100... - TIDC190...	K-TID10-19.99

Reference pages: Head → **J025 - J032**
Standard cutting conditions → **J033**

TID-R L/D=6

Exchangeable head drill, L/D = 6, Cylindrical shank

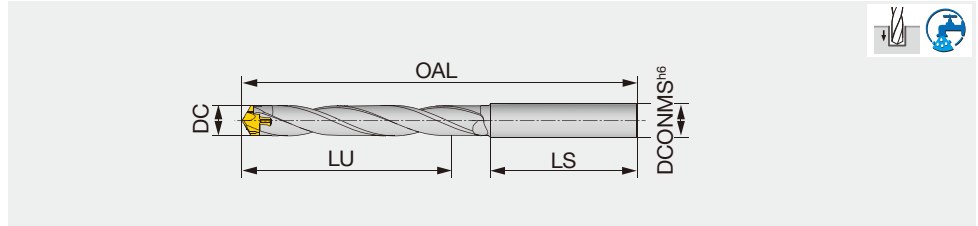

Designation	DC	DCONMS	LU	LS	OAL			Pocket size	Head
					DMP/H/N	DMC	DMF		
TID060R8-6	6 - 6.4	8	36	45	91.6	91.8	90.8	6	DM*060 - DM*064
TID065R8-6	6.5 - 6.9	8	39	45	94.7	94.9	93.9	6.5	DM*065 - DM*069
TID070R8-6	7 - 7.4	8	42	45	97.6	98	96.7	7	DM*070 - DM*074
TID075R8-6	7.5 - 7.9	8	45	45	100.6	101	99.7	7	DM*075 - DM*079
TID080R10-6	8 - 8.4	10	48	50	108.8	108.9	107.9	8	DM*080 - DM*084
TID085R10-6	8.5 - 8.9	10	51	50	111.8	111.9	110.9	8	DM*085 - DM*089
TID090R10-6	9 - 9.4	10	54	50	114.9	115.1	113.9	9	DM*090 - DM*094
TID095R10-6	9.5 - 9.9	10	57	50	117.9	118.1	116.9	9	DM*095 - DM*099
TID100R12-6	10 - 10.4	12	68	60	140	140.7	138.7	10	DM*100 - DM*104
TID105R12-6	10.5 - 10.9	12	71	60	142.9	143.6	141.6	10	DM*105 - DM*109
TID110R12-6	11 - 11.4	12	75	65	151.6	152.3	150.1	11	DM*110 - DM*114
TID115R12-6	11.5 - 11.9	12	78	65	154.5	155.2	153	11	DM*115 - DM*119
TID120R14-6	12 - 12.4	14	81	65	158.2	158.8	156.6	12	DM*120 - DM*124
TID125R14-6	12.5 - 12.9	14	84	65	161.1	161.7	159.5	12	DM*125 - DM*129
TID130R14-6	13 - 13.4	14	88	65	166.2	167	164.4	13	DM*130 - DM*134
TID135R14-6	13.5 - 13.9	14	91	65	169.2	169.9	167.3	13	DM*135 - DM*139
TID140R16-6	14 - 14.4	16	94	70	178.2	179	176.2	14	DM*140 - DM*144
TID145R16-6	14.5 - 14.9	16	97	70	181.1	181.9	179.1	14	DM*145 - DM*149
TID150R16-6	15 - 15.9	16	104	70	188.2	189.1	186.1	15	DM*150 - DM*159
TID160R18-6	16 - 16.9	18	110	70	196.2	197.2	193.9	16	DM*160 - DM*169
TID170R18-6	17 - 17.9	18	117	70	203.2	204.2	200.7	17	DM*170 - DM*179
TID180R20-6	18 - 18.9	20	124	70	211.3	212.3	208.4	18	DM*180 - DM*189
TID190R20-6	19 - 19.9	20	130	70	218.1	219.2	215.1	19	DM*190 - DM*199

Tool diameter	Hole diameter tolerance*
ø6 - ø17.9	+0.05 / 0
ø18 - ø19.9	+0.055 / 0

*Just for reference

- An overall length (OAL) differs based on each head geometry.
- When using the drill at a higher feed rate, make sure to provide an axial support by placing the overhang adjusting screw at the drill shank end in the tool holder. This will prevent high thrust force from pushing the drill back into the holder during drilling.
- When axially adjusting the shank inside the holder to obtain a required drill overhang, make sure the shank length remaining inside the holder does not come short of the minimum clamping length (LSCN) specified by the holder supplier.
- For drill diameters from ø8 - ø9.9 mm, the drill shoulder to shank bottom distance when a DMC drill head is mounted is 0.3 mm shorter when compared with a DMP head of the equivalent sizes. The distances are the same for the DMC and DMP drill heads in other diameters than the above.

SPARE PARTS

Designation	Clamping key
TID060... - TID095...	K-TID6-9.99
TID100... - TID190...	K-TID10-19.99

Reference pages: Head → **J025 - J032**
Standard cutting conditions → **J033**

DRILLMEISTER

TID L/D=8

Exchangeable head drill, L/D = 8, flange type

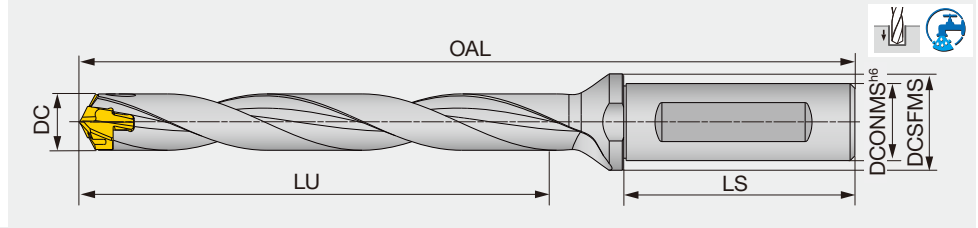

Designation	DC	DCONMS	DCSFMS	LU	LS	OAL			Pocket size	Head
						DMP/H/N	DMC	DMF		
TID070F12-8	7 - 7.4	12	16	57	45	115.5	115.9	114.6	7	DM*070 - DM*074
TID075F12-8	7.5 - 7.9	12	16	61	45	119.5	119.9	118.6	7	DM*075 - DM*079
TID080F12-8	8 - 8.4	12	16	66	45	124.3	124.4	123.4	8	DM*080 - DM*084
TID085F12-8	8.5 - 8.9	12	16	70	45	128.3	128.4	127.4	8	DM*085 - DM*089
TID090F12-8	9 - 9.4	12	16	74	45	132.7	132.8	131.6	9	DM*090 - DM*094
TID095F12-8	9.5 - 9.9	12	16	78	45	136.7	136.8	135.6	9	DM*095 - DM*099
TID100F16-8	10 - 10.4	16	20	82	48	144.1	144.7	142.7	10	DM*100 - DM*104
TID105F16-8	10.5 - 10.9	16	20	86	48	148.1	148.7	146.7	10	DM*105 - DM*109
TID110F16-8	11 - 11.4	16	20	90	48	152.5	153.1	150.9	11	DM*110 - DM*114
TID115F16-8	11.5 - 11.9	16	20	94	48	156.5	157.1	154.9	11	DM*115 - DM*119
TID120F16-8	12 - 12.4	16	20	98	48	160.8	161.4	159.2	12	DM*120 - DM*124
TID125F16-8	12.5 - 12.9	16	20	102	48	164.8	165.4	163.2	12	DM*125 - DM*129
TID130F16-8	13 - 13.4	16	20	106	48	169.4	170.2	167.5	13	DM*130 - DM*134
TID135F16-8	13.5 - 13.9	16	20	111	48	173.4	174.2	171.5	13	DM*135 - DM*139
TID140F16-8	14 - 14.4	16	20	115	48	180	180.8	178	14	DM*140 - DM*144
TID145F16-8	14.5 - 14.9	16	20	119	48	184	184.8	182	14	DM*145 - DM*149
TID150F20-8	15 - 15.9	20	25	123	50	193.5	194.4	191.4	15	DM*150 - DM*159
TID160F20-8	16 - 16.9	20	25	131	50	203.1	204.1	200.8	16	DM*160 - DM*169
TID170F20-8	17 - 17.9	20	25	139	50	212.7	213.7	210.2	17	DM*170 - DM*179
TID180F25-8	18 - 18.9	25	32	147	56	228.3	229.4	225.5	18	DM*180 - DM*189
TID190F25-8	19 - 19.9	25	32	156	56	237.8	238.9	234.8	19	DM*190 - DM*199
TID200F25-8	20 - 20.9	25	32	164	56	247.4	248.6	245.1	20	DM*200 - DM*209
TID210F25-8	21 - 21.9	25	32	172	56	257	258.2	254.5	21	DM*210 - DM*219
TID220F25-8	22 - 22.9	25	32	180	56	266.6	267.8	263.9	22	DM*220 - DM*229
TID230F32-8	23 - 23.9	32	42	188	60	280.1	281.5	277.3	23	DM*230 - DM*239
TID240F32-8	24 - 24.9	32	42	196	60	289.7	291.1	286.7	24	DM*240 - DM*249
TID250F32-8	25 - 25.9	32	42	205	60	299.3	300.8	296.2	25	DM*250 - DM*259

Tool diameter	Hole diameter tolerance*
ø7 - ø17.9	+0.05 / 0
ø18 - ø25.9	+0.055 / 0

- An overall length (OAL) differs based on each head geometry.
 - For drill diameters from ø8 - ø9.9 mm, the drill shoulder to shank bottom distance when a DMC drill head is mounted is 0.3 mm shorter when compared with a DMP head of the equivalent sizes. The distances are the same for the DMC and DMP drill heads in other diameters than the above.

*Just for reference

SPARE PARTS



Designation	Clamping key
TID070... - TID095...	K-TID6-9.99
TID100... - TID190...	K-TID10-19.99
TID200... - TID250...	K-TID20-26.99

Reference pages: Head → **J025 - J032**
 Standard cutting conditions → **J033**

TID-R L/D=8

Exchangeable head drill, L/D = 8, Cylindrical shank

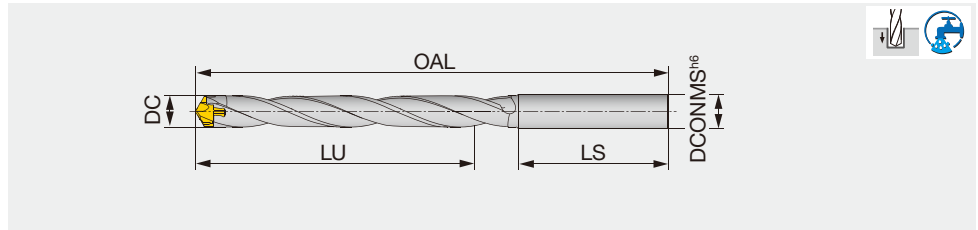

Designation	DC	DCONMS	LU	LS	OAL			Pocket size	Head
					DMP/H/N	DMC	DMF		
TID060R8-8	6 - 6.4	8	48	45	104.4	104.6	103.6	6	DM*060 - DM*064
TID065R8-8	6.5 - 6.9	8	52	45	108.5	108.7	107.7	6.5	DM*065 - DM*069
TID070R8-8	7 - 7.4	8	56	45	112.4	112.8	111.5	7	DM*070 - DM*074
TID075R8-8	7.5 - 7.9	8	60	45	116.4	116.8	115.5	7	DM*075 - DM*079
TID080R10-8	8 - 8.4	10	64	50	125.6	125.7	124.7	8	DM*080 - DM*084
TID085R10-8	8.5 - 8.9	10	68	50	129.6	129.7	128.7	8	DM*085 - DM*089
TID090R10-8	9 - 9.4	10	72	50	133.7	133.9	132.7	9	DM*090 - DM*094
TID095R10-8	9.5 - 9.9	10	76	50	137.7	137.9	136.7	9	DM*095 - DM*099
TID100R12-8	10 - 10.4	12	89	60	160.8	161.5	159.5	10	DM*100 - DM*104
TID105R12-8	10.5 - 10.9	12	93	60	164.7	165.4	163.4	10	DM*105 - DM*109
TID110R12-8	11 - 11.4	12	98	65	174.4	175.1	172.9	11	DM*110 - DM*114
TID115R12-8	11.5 - 11.9	12	102	65	178.3	179	176.8	11	DM*115 - DM*119
TID120R14-8	12 - 12.4	14	106	65	183	183.6	181.4	12	DM*120 - DM*124
TID125R14-8	12.5 - 12.9	14	110	65	186.9	187.5	185.3	12	DM*125 - DM*129
TID130R14-8	13 - 13.4	14	115	65	193	193.8	191.2	13	DM*130 - DM*134
TID135R14-8	13.5 - 13.9	14	119	65	196.9	197.7	195	13	DM*135 - DM*139
TID140R16-8	14 - 14.4	16	123	70	207	207.8	205	14	DM*140 - DM*144
TID145R16-8	14.5 - 14.9	16	127	70	210.9	211.7	208.9	14	DM*145 - DM*149
TID150R16-8	15 - 15.9	16	136	70	220	220.9	217.9	15	DM*150 - DM*159
TID160R18-8	16 - 16.9	18	144	70	230	231	227.7	16	DM*160 - DM*169
TID170R18-8	17 - 17.9	18	153	70	239	240	236.5	17	DM*170 - DM*179
TID180R20-8	18 - 18.9	20	162	70	249.1	250.1	246.2	18	DM*180 - DM*189
TID190R20-8	19 - 19.9	20	170	70	257.9	259	254.9	19	DM*190 - DM*199

Tool diameter	Hole diameter tolerance*
ø6 - ø17.9	+0.05 / 0
ø18 - ø19.9	+0.055 / 0

*Just for reference

- An overall length (OAL) differs based on each head geometry.
- When using the drill at a higher feed rate, make sure to provide an axial support by placing the overhang adjusting screw at the drill shank end in the tool holder. This will prevent high thrust force from pushing the drill back into the holder during drilling.
- When axially adjusting the shank inside the holder to obtain a required drill overhang, make sure the shank length remaining inside the holder does not come short of the minimum clamping length (LSCN) specified by the holder supplier.
- For drill diameters from ø8 - ø9.9 mm, the drill shoulder to shank bottom distance when a DMC drill head is mounted is 0.3 mm shorter when compared with a DMP head of the equivalent sizes. The distances are the same for the DMC and DMP drill heads in other diameters than the above.

SPARE PARTS



Designation	Clamping key
TID060... - TID095...	K-TID6-9.99
TID100... - TID190...	K-TID10-19.99

Reference pages: Head → **J025 - J032**
Standard cutting conditions → **J033**

DRILLMEISTER

TID L/D=12

Exchangeable head drill, L/D = 12, Cylindrical shank

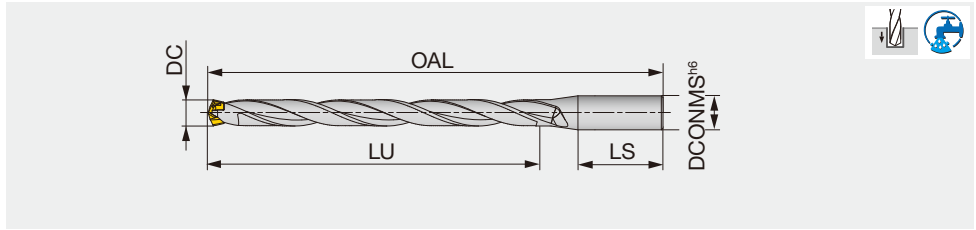

Designation	DC	DCONMS	LU	LS	OAL			Pocket size	Head
					DMP/H/N	DMC	DMF		
TID080R12-12	8 - 8.4	12	98	45	156.3	156.4	155.4	8	DM*080 - DM*084
TID085R12-12	8.5 - 8.9	12	104	45	162.3	162.4	161.4	8	DM*085 - DM*089
TID090R12-12	9 - 9.4	12	110	45	168.7	168.8	167.6	9	DM*090 - DM*094
TID095R12-12	9.5 - 9.9	12	116	45	174.7	174.8	173.6	9	DM*095 - DM*099
TID100R16-12	10 - 10.4	16	122	48	184.1	184.7	182.7	10	DM*100 - DM*104
TID105R16-12	10.5 - 10.9	16	128	48	190.1	190.7	188.7	10	DM*105 - DM*109
TID110R16-12	11 - 11.4	16	134	48	196.5	197.1	194.9	11	DM*110 - DM*114
TID115R16-12	11.5 - 11.9	16	140	48	202.5	203.1	200.9	11	DM*115 - DM*119
TID120R16-12	12 - 12.4	16	146	48	208.8	209.4	207.2	12	DM*120 - DM*124
TID125R16-12	12.5 - 12.9	16	152	48	214.8	215.4	213.2	12	DM*125 - DM*129
TID130R16-12	13 - 13.4	16	158	48	221.4	222.2	219.5	13	DM*130 - DM*134
TID135R16-12	13.5 - 13.9	16	165	48	227.4	228.2	225.5	13	DM*135 - DM*139
TID140R16-12	14 - 14.4	16	171	48	236	236.8	234	14	DM*140 - DM*144
TID145R16-12	14.5 - 14.9	16	177	48	242	242.8	240	14	DM*145 - DM*149
TID150R20-12	15 - 15.9	20	183	50	253.5	254.4	251.4	15	DM*150 - DM*159
TID160R20-12	16 - 16.9	20	195	50	267.1	268.1	264.8	16	DM*160 - DM*169
TID170R20-12	17 - 17.9	20	207	50	280.7	281.7	278.2	17	DM*170 - DM*179
TID180R25-12	18 - 18.9	25	219	56	300.3	301.4	297.5	18	DM*180 - DM*189
TID190R25-12	19 - 19.9	25	232	56	313.8	314.9	310.8	19	DM*190 - DM*199
TID200R25-12	20 - 20.9	25	244	56	327.4	328.6	325.1	20	DM*200 - DM*209
TID210R25-12	21 - 21.9	25	256	56	341	342.2	338.5	21	DM*210 - DM*219
TID220R25-12	22 - 22.9	25	267	56	354.6	355.8	351.9	22	DM*220 - DM*229
TID230R32-12	23 - 23.9	32	276	60	372.1	373.5	369.3	23	DM*230 - DM*239
TID240R32-12	24 - 24.9	32	288	60	385.7	387.1	382.7	24	DM*240 - DM*249
TID250R32-12	25 - 25.9	32	300	60	399.3	400.8	396.2	25	DM*250 - DM*259

Tool diameter	Hole diameter tolerance*
ø8 - ø17.9	+0.05 / 0
ø18 - ø25.9	+0.055 / 0

*Just for reference

- An overall length (OAL) differs based on each head geometry.
- When using the drill at a higher feed rate, make sure to provide an axial support by placing the overhang adjusting screw at the drill shank end in the tool holder. This will prevent high thrust force from pushing the drill back into the holder during drilling.
- For drill diameters from ø8 - ø9.9 mm, the drill shoulder to shank bottom distance when a DMC drill head is mounted is 0.3 mm shorter when compared with a DMP head of the equivalent sizes. The distances are the same for the DMC and DMP drill heads in other diameters than the above.

SPARE PARTS



Designation	Clamping key
TID080... - TID095...	K-TID6-9.99
TID100... - TID190...	K-TID10-19.99
TID200... - TID250...	K-TID20-26.99

Reference pages: Head → **J025 - J032**
Standard cutting conditions → **J033**

TIDCF

Chamfering adapter

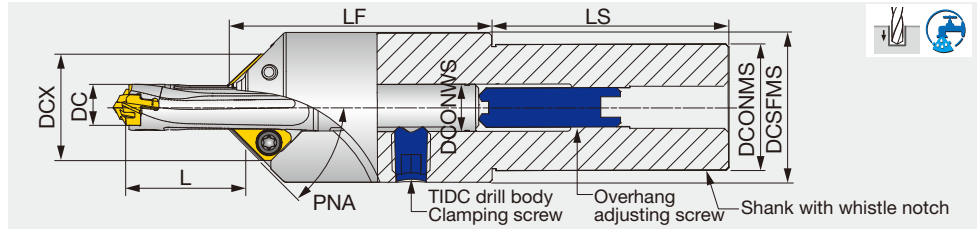

Designation	DC	DCONMS	DCSFMS	DCX	LF	LS	L* L/D = 3	L* L/D = 5	Drill body	DCONWS	Insert
TIDCF080-W20	7.5 - 7.9	20	25	18.8	47.4	50	12.6 - 24	17.3 - 38	TIDC075C8-...	8	XCGT06...
TIDCF080-W20	8.0 - 8.4	20	25	18.8	47.4	50	13.5 - 24.6	24.7 - 45	TIDC080C8-...	8	XCGT06...
TIDCF090-W20	8.5 - 8.9	20	25	19.8	47.4	50	12.6 - 26.2	18.5 - 43	TIDC085C9-...	9	XCGT06...
TIDCF090-W20	9.0 - 9.4	20	25	19.8	47.4	50	13 - 29.2	22.9 - 46.8	TIDC090C9-...	9	XCGT06...
TIDCF100-W32	9.5 - 9.9	32	38	24.9	67.3	60	12.9 - 27.8	26 - 47	TIDC095C10-...	10	XHG*09...
TIDCF100-W32	10 - 10.4	32	38	24.9	67.3	60	14.5 - 31.8	31.7 - 51.8	TIDC100C10-...	10	XHG*09...
TIDCF110-W32	10.5 - 10.9	32	38	25.9	67.3	60	15.7 - 33.3	31.2 - 54.2	TIDC105C11-...	11	XHG*09...
TIDCF110-W32	11 - 11.4	32	38	25.9	67.3	60	16.2 - 35.3	34.1 - 57.3	TIDC110C11-...	11	XHG*09...
TIDCF120-W32	11.5 - 11.9	32	38	26.9	67.3	60	15.1 - 36.7	33.8 - 59.4	TIDC115C12-...	12	XHG*09...
TIDCF120-W32	12 - 12.4	32	38	26.9	67.3	60	16.5 - 37.7	36.6 - 61.6	TIDC120C12-...	12	XHG*09...
TIDCF130-W32	12.5 - 12.9	32	38	27.9	67.3	60	16.1 - 39.6	39.7 - 64.8	TIDC125C13-...	13	XHG*09...
TIDCF130-W32	13 - 13.4	32	38	27.9	67.3	60	17.5 - 41.5	42.7 - 68	TIDC130C13-...	13	XHG*09...
TIDCF140-W32	13.5 - 13.9	32	38	28.4	67.3	60	17.7 - 42.9	41.4 - 70.3	TIDC135C14-...	14	XHG*09...
TIDCF140-W32	14 - 14.4	32	38	28.4	67.3	60	18.1 - 45	44.8 - 73.1	TIDC140C14-...	14	XHG*09...
TIDCF150-W32	14.5 - 14.9	32	38	29.4	67.3	60	19.2 - 44.6	44 - 73.9	TIDC145C15-...	15	XHG*09...
TIDCF150-W32	15 - 15.9	32	38	29.4	67.3	60	19.7 - 47.4	47.6 - 80.7	TIDC150C15-...	15	XHG*09...
TIDCF160-W32	16 - 16.9	32	38	30.4	67.3	60	19.5 - 55.3	57 - 87.5	TIDC160C16-...	16	XHG*09...
TIDCF170-W32	17 - 17.9	32	38	31.4	67.3	60	21.4 - 54.9	55.9 - 88.5	TIDC170C17-...	17	XHG*09...
TIDCF180-W32	18 - 18.9	32	38	32.4	67.3	60	24.2 - 65.2	60 - 93	TIDC180C18-...	18	XHG*09...
TIDCF190-W32	19 - 19.9	32	38	33.4	75	60	28.5 - 62.3	67 - 100	TIDC190C19-...	19	XHG*09...

L* is the dimension when using 45° chamfering insert.

SPARE PARTS

Designation	Insert screw	Grip	Clamping screw of TIDC drill body	Overhang adjusting screw	Torx bit	Wrench	Wrench
TIDCF080... - TIDCF090...	SR14-560	-	SRM6X6DIN916	SRM6X1S	-	HW3.0	T-8D
TIDCF100... - TIDCF190...	SR14-544/S	SW6-SD	SRM10X10DIN916	SRM10X1.5S	BT15S	HW5.0	-

Recommended clamping torque (N·m): SR14-544/S = 4.8

● How to mount the chamfering adapter on the TIDC drill body

The overhang length of the drill can be changed by the adjusting screw at the bottom of the adapter. The rear end of the drill body must be in contact with the adjusting screw as the screw supports the drill against thrust force when drilling.

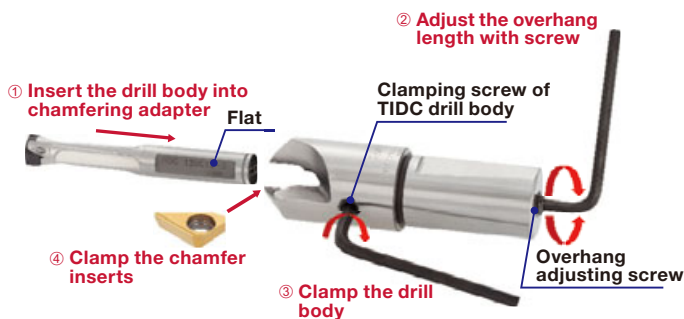

Procedures

- Place the TIDC drill body into the chamfering adapter without chamfer inserts.
- Adjust the overhang length of the drill body with the adjusting screw at the bottom of the adapter.
- Adjust the position of the drill body so that the drill body is fixed at the flat and tighten the clamping screw of the drill body. This aligns the flutes of the TIDC drill body with the chamfer inserts.
- To clamp the chamfer inserts, tighten the clamping screw of the insert while pushing the insert into the insert pocket.

Notice: Before removing the drill body from the adapter, chamfer inserts must be unclamped. The overhang adjusting screw can be handled from the top of the adapter with a flat-blade screwdriver. The overhang length of the drill body can be adjusted after the adapter is positioned on the drill shank.



DRILL HEAD

DMP (General purpose)

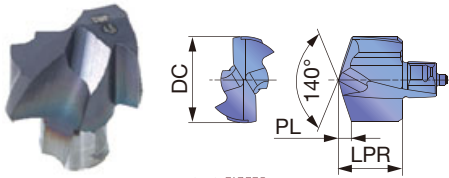

ADDMETER
DMP040 - DMP059

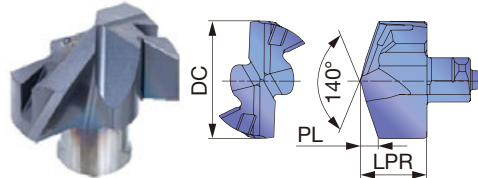

DRILLMEISTER
DMP060 - DMP259

Tool diameter	Head diameter tolerance
ø4 - ø17.9	+0.018 / 0
ø18 - ø25.9	+0.021 / 0

P	Steel	☆	★
M	Stainless	☆	★
K	Cast iron	☆	★
N	Non-ferrous		
S	Superalloys	☆	★
H	Hard materials	☆	★

P	Steel	☆	★
M	Stainless	☆	★
K	Cast iron	☆	★
N	Non-ferrous		
S	Superalloys	☆	★
H	Hard materials	☆	★

★ : First choice
☆ : Second choice

Designation	DC	LPR	Coated		PL	Body
			AH725	AH9130		
DMP040	4	3.1	●		0.62	TID*040...
DMP041	4.1	3.1	●		0.64	TID*040...
DMP042	4.2	3.1	●		0.66	TID*040...
DMP043	4.3	3.1	●		0.67	TID*040...
DMP044	4.4	3.1	●		0.69	TID*040...
DMP045	4.5	3.55	●		0.66	TID*045...
DMP046	4.6	3.55	●		0.68	TID*045...
DMP047	4.7	3.55	●		0.70	TID*045...
DMP048	4.8	3.55	●		0.71	TID*045...
DMP049	4.9	3.55	●		0.73	TID*045...
DMP050	5	3.7	●		0.73	TID*050...
DMP051	5.1	3.7	●		0.75	TID*050...
DMP052	5.2	3.7	●		0.77	TID*050...
DMP053	5.3	3.7	●		0.78	TID*050...
DMP054	5.4	3.7	●		0.8	TID*050...
DMP055	5.5	3.85	●		0.81	TID*055...
DMP056	5.6	3.85	●		0.83	TID*055...
DMP057	5.7	3.85	●		0.85	TID*055...
DMP058	5.8	3.85	●		0.86	TID*055...
DMP059	5.9	3.85	●		0.88	TID*055...
DMP060	6	3.85	●	●	1.09	TID*060...
DMP061	6.1	3.85	●	●	1.11	TID*060...
DMP062	6.2	3.85	●	●	1.13	TID*060...
DMP063	6.3	3.85	●	●	1.14	TID*060...
DMP064	6.4	3.85	●	●	1.16	TID*060...
DMP065	6.5	4.15	●	●	1.27	TID*065...
DMP066	6.6	4.15	●	●	1.29	TID*065...
DMP067	6.7	4.15	●	●	1.31	TID*065...
DMP068	6.8	4.15	●	●	1.33	TID*065...
DMP069	6.9	4.15	●	●	1.34	TID*065...
DMP070	7	4.45	●	●	1.03	TID*070...
DMP071	7.1	4.45	●	●	1.05	TID*070...
DMP072	7.2	4.45	●	●	1.07	TID*070...
DMP073	7.3	4.45	●	●	1.08	TID*070...
DMP074	7.4	4.45	●	●	1.1	TID*070...
DMP075	7.5	4.45	●	●	1.12	TID*075...
DMP076	7.6	4.45	●	●	1.14	TID*075...
DMP077	7.7	4.45	●	●	1.16	TID*075...
DMP078	7.8	4.45	●	●	1.18	TID*075...
DMP079	7.9	4.45	●	●	1.19	TID*075...
DMP080	8	5.25	●	●	1.2	TID*080...
DMP081	8.1	5.25	●	●	1.22	TID*080...
DMP082	8.2	5.25	●	●	1.24	TID*080...

Designation	DC	LPR	Coated		PL	Body
			AH725	AH9130		
DMP083	8.3	5.25	●	●	1.25	TID*080...
DMP084	8.4	5.25	●	●	1.27	TID*080...
DMP085	8.5	5.25	●	●	1.29	TID*085...
DMP086	8.6	5.25	●	●	1.31	TID*085...
DMP087	8.7	5.25	●	●	1.33	TID*085...
DMP088	8.8	5.25	●	●	1.35	TID*085...
DMP089	8.9	5.25	●	●	1.36	TID*085...
DMP090	9	5.65	●	●	1.37	TID*090...
DMP091	9.1	5.65	●	●	1.39	TID*090...
DMP092	9.2	5.65	●	●	1.41	TID*090...
DMP093	9.3	5.65	●	●	1.42	TID*090...
DMP094	9.4	5.65	●	●	1.44	TID*090...
DMP095	9.5	5.65	●	●	1.46	TID*095...
DMP096	9.6	5.65	●	●	1.48	TID*095...
DMP097	9.7	5.65	●	●	1.5	TID*095...
DMP098	9.8	5.65	●	●	1.52	TID*095...
DMP099	9.9	5.65	●	●	1.53	TID*095...
DMP100	10	6.05	●	●	1.47	TID*100...
DMP101	10.1	6.05	●	●	1.49	TID*100...
DMP102	10.2	6.05	●	●	1.51	TID*100...
DMP103	10.3	6.05	●	●	1.52	TID*100...
DMP104	10.4	6.05	●	●	1.54	TID*100...
DMP105	10.5	6.05	●	●	1.56	TID*105...
DMP106	10.6	6.05	●	●	1.58	TID*105...
DMP107	10.7	6.05	●	●	1.6	TID*105...
DMP108	10.8	6.05	●	●	1.62	TID*105...
DMP109	10.9	6.05	●	●	1.63	TID*105...
DMP110	11	6.45	●	●	1.67	TID*110...
DMP111	11.1	6.45	●	●	1.69	TID*110...
DMP112	11.2	6.45	●	●	1.71	TID*110...
DMP113	11.3	6.45	●	●	1.72	TID*110...
DMP114	11.4	6.45	●	●	1.74	TID*110...
DMP115	11.5	6.45	●	●	1.76	TID*115...
DMP116	11.6	6.45	●	●	1.78	TID*115...
DMP117	11.7	6.45	●	●	1.8	TID*115...
DMP118	11.8	6.45	●	●	1.82	TID*115...
DMP119	11.9	6.45	●	●	1.83	TID*115...
DMP120	12	6.8	●	●	1.82	TID*120...
DMP121	12.1	6.8	●	●	1.84	TID*120...
DMP122	12.2	6.8	●	●	1.86	TID*120...
DMP123	12.3	6.8	●	●	1.87	TID*120...
DMP124	12.4	6.8	●	●	1.89	TID*120...
DMP125	12.5	6.8	●	●	1.91	TID*125...

ø4 - ø19.9 = 2 pieces per package
ø20 - ø25.9 = 1 piece per package

● : Line up

DMP (General purpose)

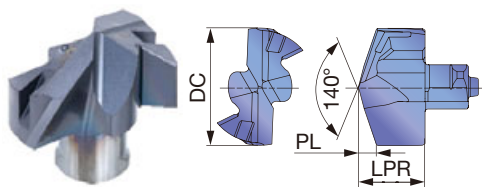

DRILLMEISTER
 DMP060 - DMP259

Tool diameter

ø4 - ø17.9
 ø18 - ø25.9

Head diameter tolerance

+0.018 / 0
 +0.021 / 0

P	Steel	☆	★
M	Stainless	☆	★
K	Cast iron	☆	★
N	Non-ferrous		
S	Superalloys	☆	★
H	Hard materials	☆	★

P	Steel	☆	★
M	Stainless	☆	★
K	Cast iron	☆	★
N	Non-ferrous		
S	Superalloys	☆	★
H	Hard materials	☆	★

★ : First choice
 ☆ : Second choice

Designation	DC	LPR	Coated		PL	Body
			AH725	AH9130		
DMP126	12.6	6.8	●	●	1.93	TID*125...
DMP127	12.7	6.8	●	●	1.95	TID*125...
DMP128	12.8	6.8	●	●	1.97	TID*125...
DMP129	12.9	6.8	●	●	1.98	TID*125...
DMP130	13	7.4	●	●	1.96	TID*130...
DMP131	13.1	7.4	●	●	1.98	TID*130...
DMP132	13.2	7.4	●	●	2	TID*130...
DMP133	13.3	7.4	●	●	2.01	TID*130...
DMP134	13.4	7.4	●	●	2.03	TID*130...
DMP135	13.5	7.4	●	●	2.05	TID*135...
DMP136	13.6	7.4	●	●	2.07	TID*135...
DMP137	13.7	7.4	●	●	2.09	TID*135...
DMP138	13.8	7.4	●	●	2.11	TID*135...
DMP139	13.9	7.4	●	●	2.12	TID*135...
DMP140	14	7.95	●	●	2.12	TID*140...
DMP141	14.1	7.95	●	●	2.14	TID*140...
DMP142	14.2	7.95	●	●	2.16	TID*140...
DMP143	14.3	7.95	●	●	2.17	TID*140...
DMP144	14.4	7.95	●	●	2.19	TID*140...
DMP145	14.5	7.95	●	●	2.21	TID*145...
DMP146	14.6	7.95	●	●	2.23	TID*145...
DMP147	14.7	7.95	●	●	2.25	TID*145...
DMP148	14.8	7.95	●	●	2.27	TID*145...
DMP149	14.9	7.95	●	●	2.28	TID*145...
DMP150	15	8.53	●	●	2.27	TID*150...
DMP151	15.1	8.53	●	●	2.29	TID*150...
DMP152	15.2	8.53	●	●	2.31	TID*150...
DMP153	15.3	8.53	●	●	2.32	TID*150...
DMP154	15.4	8.53	●	●	2.34	TID*150...
DMP155	15.5	8.53	●	●	2.36	TID*150...
DMP156	15.6	8.53	●	●	2.38	TID*150...
DMP157	15.7	8.53	●	●	2.4	TID*150...
DMP158	15.8	8.53	●	●	2.42	TID*150...
DMP159	15.9	8.53	●	●	2.43	TID*150...
DMP160	16	9.1	●	●	2.42	TID*160...
DMP161	16.1	9.1	●	●	2.44	TID*160...
DMP162	16.2	9.1	●	●	2.46	TID*160...
DMP163	16.3	9.1	●	●	2.47	TID*160...
DMP164	16.4	9.1	●	●	2.49	TID*160...
DMP165	16.5	9.1	●	●	2.51	TID*160...
DMP166	16.6	9.1	●	●	2.53	TID*160...
DMP167	16.7	9.1	●	●	2.55	TID*160...
DMP168	16.8	9.1	●	●	2.57	TID*160...

Designation	DC	LPR	Coated		PL	Body
			AH725	AH9130		
DMP169	16.9	9.1	●	●	2.58	TID*160...
DMP170	17	9.7	●	●	2.59	TID*170...
DMP171	17.1	9.7	●	●	2.61	TID*170...
DMP172	17.2	9.7	●	●	2.63	TID*170...
DMP173	17.3	9.7	●	●	2.64	TID*170...
DMP174	17.4	9.7	●	●	2.66	TID*170...
DMP175	17.5	9.7	●	●	2.68	TID*170...
DMP176	17.6	9.7	●	●	2.7	TID*170...
DMP177	17.7	9.7	●	●	2.72	TID*170...
DMP178	17.8	9.7	●	●	2.74	TID*170...
DMP179	17.9	9.7	●	●	2.75	TID*170...
DMP180	18	10.3	●	●	2.73	TID*180...
DMP181	18.1	10.3	●	●	2.75	TID*180...
DMP182	18.2	10.3	●	●	2.77	TID*180...
DMP183	18.3	10.3	●	●	2.78	TID*180...
DMP184	18.4	10.3	●	●	2.8	TID*180...
DMP185	18.5	10.3	●	●	2.82	TID*180...
DMP186	18.6	10.3	●	●	2.84	TID*180...
DMP187	18.7	10.3	●	●	2.86	TID*180...
DMP188	18.8	10.3	●	●	2.88	TID*180...
DMP189	18.9	10.3	●	●	2.89	TID*180...
DMP190	19	10.8	●	●	2.88	TID*190...
DMP1905	19.05	10.8	●	●	2.89	TID*190...
DMP191	19.1	10.8	●	●	2.9	TID*190...
DMP192	19.2	10.8	●	●	2.92	TID*190...
DMP1927	19.27	10.8	●	●	2.93	TID*190...
DMP193	19.3	10.8	●	●	2.93	TID*190...
DMP194	19.4	10.8	●	●	2.95	TID*190...
DMP195	19.5	10.8	●	●	2.97	TID*190...
DMP196	19.6	10.8	●	●	2.99	TID*190...
DMP197	19.7	10.8	●	●	3.01	TID*190...
DMP198	19.8	10.8	●	●	3.03	TID*190...
DMP199	19.9	10.8	●	●	3.04	TID*190...
DMP200	20	11.4	●	●	3.02	TID*200...
DMP201	20.1	11.4	●	●	3.04	TID*200...
DMP202	20.2	11.4	●	●	3.06	TID*200...
DMP203	20.3	11.4	●	●	3.07	TID*200...
DMP204	20.4	11.4	●	●	3.09	TID*200...
DMP205	20.5	11.4	●	●	3.11	TID*200...
DMP206	20.6	11.4	●	●	3.13	TID*200...
DMP207	20.7	11.4	●	●	3.15	TID*200...
DMP208	20.8	11.4	●	●	3.17	TID*200...
DMP209	20.9	11.4	●	●	3.18	TID*200...

ø4 - ø19.9 = 2 pieces per package
 ø20 - ø25.9 = 1 piece per package

● : Line up

P	Steel	☆	★
M	Stainless	☆	★
K	Cast iron	☆	★
N	Non-ferrous	☆	★
S	Superalloys	☆	★
H	Hard materials	☆	★

★ : First choice
☆ : Second choice

Designation	DC	LPR	Coated		PL	Body
			AH725	AH9130		
DMP206	20.6	11.4	●	●	3.13	TID*200...
DMP207	20.7	11.4	●	●	3.15	TID*200...
DMP208	20.8	11.4	●	●	3.17	TID*200...
DMP209	20.9	11.4	●	●	3.18	TID*200...
DMP210	21	11.98	●	●	3.18	TID*210...
DMP211	21.1	11.98	●	●	3.2	TID*210...
DMP212	21.2	11.98	●	●	3.22	TID*210...
DMP213	21.3	11.98	●	●	3.23	TID*210...
DMP214	21.4	11.98	●	●	3.25	TID*210...
DMP215	21.5	11.98	●	●	3.27	TID*210...
DMP216	21.6	11.98	●	●	3.29	TID*210...
DMP217	21.7	11.98	●	●	3.31	TID*210...
DMP218	21.8	11.98	●	●	3.33	TID*210...
DMP219	21.9	11.98	●	●	3.34	TID*210...
DMP220	22	12.56	●	●	3.32	TID*220...
DMP221	22.1	12.56	●	●	3.34	TID*220...
DMP222	22.2	12.56	●	●	3.36	TID*220...
DMP223	22.3	12.56	●	●	3.37	TID*220...
DMP224	22.4	12.56	●	●	3.39	TID*220...
DMP225	22.5	12.56	●	●	3.41	TID*220...
DMP226	22.6	12.56	●	●	3.43	TID*220...
DMP227	22.7	12.56	●	●	3.45	TID*220...
DMP228	22.8	12.56	●	●	3.47	TID*220...
DMP229	22.9	12.56	●	●	3.48	TID*220...
DMP230	23	13.13	●	●	3.46	TID*230...
DMP231	23.1	13.13	●	●	3.48	TID*230...
DMP232	23.2	13.13	●	●	3.5	TID*230...
DMP233	23.3	13.13	●	●	3.51	TID*230...
DMP234	23.4	13.13	●	●	3.53	TID*230...
DMP235	23.5	13.13	●	●	3.55	TID*230...
DMP236	23.6	13.13	●	●	3.57	TID*230...
DMP237	23.7	13.13	●	●	3.59	TID*230...
DMP238	23.8	13.13	●	●	3.61	TID*230...
DMP239	23.9	13.13	●	●	3.62	TID*230...
DMP240	24	13.7	●	●	3.62	TID*240...
DMP241	24.1	13.7	●	●	3.64	TID*240...
DMP242	24.2	13.7	●	●	3.66	TID*240...
DMP243	24.3	13.7	●	●	3.67	TID*240...
DMP244	24.4	13.7	●	●	3.69	TID*240...
DMP245	24.5	13.7	●	●	3.71	TID*240...
DMP246	24.6	13.7	●	●	3.73	TID*240...
DMP247	24.7	13.7	●	●	3.75	TID*240...
DMP248	24.8	13.7	●	●	3.77	TID*240...
DMP249	24.9	13.7	●	●	3.78	TID*240...
DMP250	25	14.3	●	●	3.8	TID*250...
DMP251	25.1	14.3	●	●	3.82	TID*250...
DMP252	25.2	14.3	●	●	3.84	TID*250...
DMP253	25.3	14.3	●	●	3.85	TID*250...
DMP254	25.4	14.3	●	●	3.87	TID*250...
DMP255	25.5	14.3	●	●	3.89	TID*250...
DMP256	25.6	14.3	●	●	3.91	TID*250...
DMP2567	25.67	14.3	●	●	3.92	TID*250...
DMP257	25.7	14.3	●	●	3.93	TID*250...
DMP258	25.8	14.3	●	●	3.95	TID*250...
DMP259	25.9	14.3	●	●	3.96	TID*250...

ø4 - ø19.9 = 2 pieces per package
ø20 - ø25.9 = 1 piece per package

● : Line up

Grade
Insert
Ext. Toolholder
Int. Toolholder
Threading
Grooving
Miniature tool
Milling cutter
Endmill
Drilling tool
Tooling System
User's Guide
Index



DMC (High precision hole making)

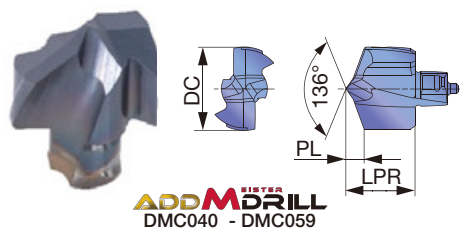

ADD M DRILL
 DMC040 - DMC059

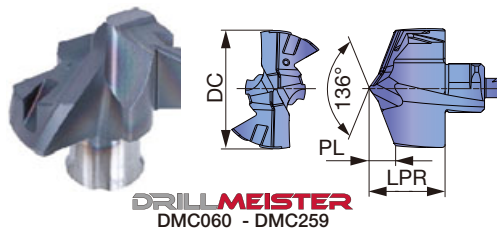

DRILLMEISTER
 DMC060 - DMC259

Tool diameter	Head diameter tolerance
ø4 - ø17.9	+0.018 / 0
ø18 - ø25.9	+0.021 / 0

P	Steel	★		
M	Stainless	★		
K	Cast iron	★		
N	Non-ferrous	☆		
S	Superalloys	★		
H	Hard materials	★		

P	Steel	★		
M	Stainless	★		
K	Cast iron	★		
N	Non-ferrous	☆		
S	Superalloys	★		
H	Hard materials	★		

★ : First choice
 ☆ : Second choice

Designation	DC	LPR	Coated		PL	Body
			AH9130			
DMC040	4	3.51	●		0.86	TID*040...
DMC041	4.1	3.51	●		0.88	TID*040...
DMC042	4.2	3.51	●		0.9	TID*040...
DMC043	4.3	3.51	●		0.92	TID*040...
DMC044	4.4	3.51	●		0.94	TID*040...
DMC045	4.5	3.81	●		0.97	TID*045...
DMC046	4.6	3.81	●		0.99	TID*045...
DMC047	4.7	3.81	●		1.01	TID*045...
DMC048	4.8	3.81	●		1.03	TID*045...
DMC049	4.9	3.81	●		1.05	TID*045...
DMC050	5	4.14	●		1.09	TID*050...
DMC051	5.1	4.14	●		1.11	TID*050...
DMC052	5.2	4.14	●		1.13	TID*050...
DMC053	5.3	4.14	●		1.15	TID*050...
DMC054	5.4	4.14	●		1.17	TID*050...
DMC055	5.5	4.17	●		1.22	TID*055...
DMC056	5.6	4.17	●		1.24	TID*055...
DMC057	5.7	4.17	●		1.26	TID*055...
DMC058	5.8	4.17	●		1.28	TID*055...
DMC059	5.9	4.17	●		1.3	TID*055...
DMC060	6	4	●		1.24	TID*060...
DMC061	6.1	4	●		1.26	TID*060...
DMC062	6.2	4	●		1.28	TID*060...
DMC063	6.3	4	●		1.3	TID*060...
DMC064	6.4	4	●		1.32	TID*060...
DMC065	6.5	4.3	●		1.33	TID*065...
DMC066	6.6	4.3	●		1.35	TID*065...
DMC067	6.7	4.3	●		1.37	TID*065...
DMC068	6.8	4.3	●		1.39	TID*065...
DMC069	6.9	4.3	●		1.41	TID*065...
DMC070	7	4.9	●		1.48	TID*070...
DMC071	7.1	4.9	●		1.5	TID*070...
DMC072	7.2	4.9	●		1.52	TID*070...
DMC073	7.3	4.9	●		1.54	TID*070...
DMC074	7.4	4.9	●		1.56	TID*070...
DMC075	7.5	4.9	●		1.58	TID*075...
DMC076	7.6	4.9	●		1.6	TID*075...
DMC077	7.7	4.9	●		1.62	TID*075...
DMC078	7.8	4.9	●		1.64	TID*075...
DMC079	7.9	4.9	●		1.66	TID*075...
DMC080	8	5.4	●		1.62	TID*080...
DMC081	8.1	5.4	●		1.64	TID*080...
DMC082	8.2	5.4	●		1.66	TID*080...
DMC083	8.3	5.4	●		1.68	TID*080...
DMC084	8.4	5.4	●		1.7	TID*080...
DMC085	8.5	5.4	●		1.72	TID*085...
DMC086	8.6	5.4	●		1.74	TID*085...
DMC087	8.7	5.4	●		1.76	TID*085...
DMC088	8.8	5.4	●		1.78	TID*085...
DMC089	8.9	5.4	●		1.8	TID*085...

Designation	DC	LPR	Coated		PL	Body
			AH9130			
DMC090	9	5.8	●		1.91	TID*090...
DMC091	9.1	5.8	●		1.93	TID*090...
DMC092	9.2	5.8	●		1.95	TID*090...
DMC093	9.3	5.8	●		1.97	TID*090...
DMC094	9.4	5.8	●		1.99	TID*090...
DMC095	9.5	5.8	●		2.01	TID*095...
DMC096	9.6	5.8	●		2.03	TID*095...
DMC097	9.7	5.8	●		2.05	TID*095...
DMC098	9.8	5.8	●		2.07	TID*095...
DMC099	9.9	5.8	●		2.09	TID*095...
DMC100	10	6.67	●		2.09	TID*100...
DMC101	10.1	6.67	●		2.11	TID*100...
DMC102	10.2	6.67	●		2.13	TID*100...
DMC103	10.3	6.67	●		2.15	TID*100...
DMC104	10.4	6.67	●		2.17	TID*100...
DMC105	10.5	6.67	●		2.19	TID*105...
DMC106	10.6	6.67	●		2.21	TID*105...
DMC107	10.7	6.67	●		2.23	TID*105...
DMC108	10.8	6.67	●		2.25	TID*105...
DMC109	10.9	6.67	●		2.27	TID*105...
DMC110	11	7.1	●		2.32	TID*110...
DMC111	11.1	7.1	●		2.34	TID*110...
DMC112	11.2	7.1	●		2.36	TID*110...
DMC113	11.3	7.1	●		2.38	TID*110...
DMC114	11.4	7.1	●		2.4	TID*110...
DMC115	11.5	7.1	●		2.42	TID*115...
DMC116	11.6	7.1	●		2.44	TID*115...
DMC117	11.7	7.1	●		2.46	TID*115...
DMC118	11.8	7.1	●		2.48	TID*115...
DMC119	11.9	7.1	●		2.5	TID*115...
DMC120	12	7.43	●		2.45	TID*120...
DMC121	12.1	7.43	●		2.47	TID*120...
DMC122	12.2	7.43	●		2.49	TID*120...
DMC123	12.3	7.43	●		2.51	TID*120...
DMC124	12.4	7.43	●		2.53	TID*120...
DMC125	12.5	7.43	●		2.55	TID*125...
DMC126	12.6	7.43	●		2.57	TID*125...
DMC127	12.7	7.43	●		2.59	TID*125...
DMC128	12.8	7.43	●		2.61	TID*125...
DMC129	12.9	7.43	●		2.63	TID*125...
DMC130	13	8.15	●		2.71	TID*130...
DMC131	13.1	8.15	●		2.73	TID*130...
DMC132	13.2	8.15	●		2.75	TID*130...
DMC133	13.3	8.15	●		2.77	TID*130...
DMC134	13.4	8.15	●		2.79	TID*130...
DMC135	13.5	8.15	●		2.81	TID*135...
DMC136	13.6	8.15	●		2.83	TID*135...
DMC137	13.7	8.15	●		2.85	TID*135...

ø4 - ø19.9 = 2 pieces per package
 ø20 - ø25.9 = 1 piece per package

● : Line up

P	Steel	★		
M	Stainless	★		
K	Cast iron	★		
N	Non-ferrous	☆		
S	Superalloys	★		
H	Hard materials	★		

P	Steel	★		
M	Stainless	★		
K	Cast iron	★		
N	Non-ferrous	☆		
S	Superalloys	★		
H	Hard materials	★		

★ : First choice
☆ : Second choice

Designation	DC	LPR	Coated		PL	Body
			AH9130			
DMC138	13.8	8.15	●		2.87	TID*135...
DMC139	13.9	8.15	●		2.89	TID*135...
DMC140	14	8.76	●		2.93	TID*140...
DMC141	14.1	8.76	●		2.95	TID*140...
DMC142	14.2	8.76	●		2.97	TID*140...
DMC143	14.3	8.76	●		2.99	TID*140...
DMC144	14.4	8.76	●		3.01	TID*140...
DMC145	14.5	8.76	●		3.03	TID*145...
DMC146	14.6	8.76	●		3.05	TID*145...
DMC147	14.7	8.76	●		3.07	TID*145...
DMC148	14.8	8.76	●		3.09	TID*145...
DMC149	14.9	8.76	●		3.11	TID*145...
DMC150	15	9.44	●		3.18	TID*150...
DMC151	15.1	9.44	●		3.2	TID*150...
DMC152	15.2	9.44	●		3.22	TID*150...
DMC153	15.3	9.44	●		3.24	TID*150...
DMC154	15.4	9.44	●		3.26	TID*150...
DMC155	15.5	9.44	●		3.28	TID*150...
DMC156	15.6	9.44	●		3.3	TID*150...
DMC157	15.7	9.44	●		3.32	TID*150...
DMC158	15.8	9.44	●		3.34	TID*150...
DMC159	15.9	9.44	●		3.36	TID*150...
DMC160	16	10.07	●		3.39	TID*160...
DMC161	16.1	10.07	●		3.41	TID*160...
DMC162	16.2	10.07	●		3.43	TID*160...
DMC163	16.3	10.07	●		3.45	TID*160...
DMC164	16.4	10.07	●		3.47	TID*160...
DMC165	16.5	10.07	●		3.49	TID*160...
DMC166	16.6	10.07	●		3.51	TID*160...
DMC167	16.7	10.07	●		3.53	TID*160...
DMC168	16.8	10.07	●		3.55	TID*160...
DMC169	16.9	10.07	●		3.57	TID*160...
DMC170	17	10.68	●		3.57	TID*170...
DMC171	17.1	10.68	●		3.59	TID*170...
DMC172	17.2	10.68	●		3.61	TID*170...
DMC173	17.3	10.68	●		3.63	TID*170...
DMC174	17.4	10.68	●		3.65	TID*170...
DMC175	17.5	10.68	●		3.67	TID*170...
DMC176	17.6	10.68	●		3.69	TID*170...
DMC177	17.7	10.68	●		3.71	TID*170...
DMC178	17.8	10.68	●		3.73	TID*170...
DMC179	17.9	10.68	●		3.75	TID*170...
DMC180	18	11.35	●		3.78	TID*180...
DMC181	18.1	11.35	●		3.8	TID*180...
DMC182	18.2	11.35	●		3.82	TID*180...
DMC183	18.3	11.35	●		3.84	TID*180...
DMC184	18.4	11.35	●		3.86	TID*180...
DMC185	18.5	11.35	●		3.88	TID*180...
DMC186	18.6	11.35	●		3.9	TID*180...
DMC187	18.7	11.35	●		3.92	TID*180...
DMC188	18.8	11.35	●		3.94	TID*180...
DMC189	18.9	11.35	●		3.96	TID*180...
DMC190	19	11.91	●		3.99	TID*190...
DMC191	19.1	11.91	●		4.01	TID*190...
DMC192	19.2	11.91	●		4.03	TID*190...
DMC1927	19.27	11.91	●		4.04	TID*190...
DMC193	19.3	11.91	●		4.05	TID*190...
DMC194	19.4	11.91	●		4.07	TID*190...
DMC195	19.5	11.91	●		4.09	TID*190...
DMC196	19.6	11.91	●		4.11	TID*190...
DMC197	19.7	11.91	●		4.13	TID*190...
DMC198	19.8	11.91	●		4.15	TID*190...
DMC199	19.9	11.91	●		4.17	TID*190...

Designation	DC	LPR	Coated		PL	Body
			AH9130			
DMC200	20	12.62	●		4.24	TID*200...
DMC201	20.1	12.62	●		4.26	TID*200...
DMC202	20.2	12.62	●		4.28	TID*200...
DMC203	20.3	12.62	●		4.3	TID*200...
DMC204	20.4	12.62	●		4.32	TID*200...
DMC205	20.5	12.62	●		4.34	TID*200...
DMC206	20.6	12.62	●		4.36	TID*200...
DMC207	20.7	12.62	●		4.38	TID*200...
DMC208	20.8	12.62	●		4.4	TID*200...
DMC209	20.9	12.62	●		4.42	TID*200...
DMC210	21	13.2	●		4.4	TID*210...
DMC211	21.1	13.2	●		4.42	TID*210...
DMC212	21.2	13.2	●		4.44	TID*210...
DMC213	21.3	13.2	●		4.46	TID*210...
DMC214	21.4	13.2	●		4.48	TID*210...
DMC215	21.5	13.2	●		4.5	TID*210...
DMC216	21.6	13.2	●		4.52	TID*210...
DMC217	21.7	13.2	●		4.54	TID*210...
DMC218	21.8	13.2	●		4.56	TID*210...
DMC219	21.9	13.2	●		4.58	TID*210...
DMC220	22	13.84	●		4.6	TID*220...
DMC221	22.1	13.84	●		4.62	TID*220...
DMC222	22.2	13.84	●		4.64	TID*220...
DMC223	22.3	13.84	●		4.66	TID*220...
DMC224	22.4	13.84	●		4.68	TID*220...
DMC225	22.5	13.84	●		4.7	TID*220...
DMC226	22.6	13.84	●		4.72	TID*220...
DMC227	22.7	13.84	●		4.74	TID*220...
DMC228	22.8	13.84	●		4.76	TID*220...
DMC229	22.9	13.84	●		4.78	TID*220...
DMC230	23	14.51	●		4.84	TID*230...
DMC231	23.1	14.51	●		4.84	TID*220...
DMC232	23.2	14.51	●		4.86	TID*230...
DMC233	23.3	14.51	●		4.88	TID*220...
DMC234	23.4	14.51	●		4.9	TID*230...
DMC235	23.5	14.51	●		4.94	TID*230...
DMC236	23.6	14.51	●		4.94	TID*230...
DMC237	23.7	14.51	●		4.96	TID*230...
DMC238	23.8	14.51	●		4.98	TID*230...
DMC239	23.9	14.51	●		5	TID*230...
DMC240	24	15.11	●		5.03	TID*240...
DMC241	24.1	15.11	●		5.24	TID*240...
DMC242	24.2	15.11	●		5.26	TID*240...
DMC243	24.3	15.11	●		5.28	TID*240...
DMC244	24.4	15.11	●		5.3	TID*240...
DMC245	24.5	15.11	●		5.13	TID*240...
DMC246	24.6	15.11	●		5.34	TID*240...
DMC247	24.7	15.11	●		5.36	TID*240...
DMC248	24.8	15.11	●		5.38	TID*240...
DMC249	24.9	15.11	●		5.4	TID*240...
DMC250	25	15.78	●		5.28	TID*250...
DMC251	25.1	15.78	●		5.71	TID*250...
DMC252	25.2	15.78	●		5.73	TID*250...
DMC253	25.3	15.78	●		5.34	TID*250...
DMC254	25.4	15.78	●		5.77	TID*250...
DMC255	25.5	15.78	●		5.38	TID*250...
DMC256	25.6	15.78	●		5.81	TID*250...
DMC2567	25.67	15.78	●		5.42	TID*250...
DMC257	25.7	15.78	●		5.83	TID*250...
DMC258	25.8	15.78	●		5.85	TID*250...
DMC259	25.9	15.78	●		5.46	TID*250...

ø4 - ø19.9 = 2 pieces per package
ø20 - ø25.9 = 1 piece per package

● : Line up



DRILL HEAD

DMF (Flat geometry head)

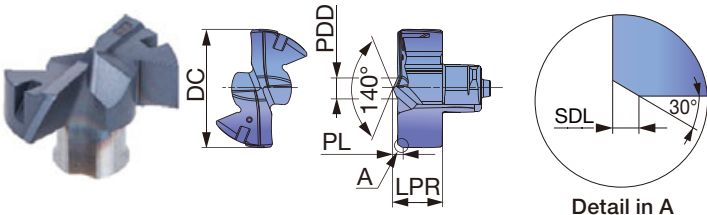

Tool diameter	Head diameter tolerance
ø6 - ø17.9	+0.018 / 0
ø18 - ø25.9	+0.021 / 0

Material	Performance	Coated	Star
P Steel	★	■	★
M Stainless	★	■	★
K Cast iron	★	■	★
N Non-ferrous	☆	■	☆
S Superalloys	★	■	★
H Hard materials	★	■	★

Material	Performance	Coated	Star
P Steel	★	■	★
M Stainless	★	■	★
K Cast iron	★	■	★
N Non-ferrous	☆	■	☆
S Superalloys	★	■	★
H Hard materials	★	■	★

★ : First choice
☆ : Second choice

Designation	DC	LPR	Coated		SDL	PL	PDD	Body
			AH9130	■				
DMF060	6	3.01	●	■	0.4	0.61	1.15	TID*060...
DMF061	6.1	3.01	●	■	0.4	0.61	1.15	TID*060...
DMF062	6.2	3.01	●	■	0.4	0.61	1.15	TID*060...
DMF063	6.3	3.01	●	■	0.4	0.61	1.15	TID*060...
DMF064	6.4	3.01	●	■	0.4	0.61	1.15	TID*060...
DMF065	6.5	3.28	●	■	0.4	0.68	1.54	TID*065...
DMF066	6.6	3.28	●	■	0.4	0.68	1.54	TID*065...
DMF067	6.7	3.28	●	■	0.4	0.68	1.54	TID*065...
DMF068	6.8	3.28	●	■	0.4	0.68	1.54	TID*065...
DMF069	6.9	3.28	●	■	0.4	0.68	1.54	TID*065...
DMF070	7	3.58	●	■	0.4	0.68	1.54	TID*070...
DMF071	7.1	3.58	●	■	0.4	0.68	1.54	TID*070...
DMF072	7.2	3.58	●	■	0.4	0.68	1.54	TID*070...
DMF073	7.3	3.58	●	■	0.4	0.68	1.54	TID*070...
DMF074	7.4	3.58	●	■	0.4	0.68	1.54	TID*070...
DMF075	7.5	3.58	●	■	0.4	0.68	1.54	TID*075...
DMF076	7.6	3.58	●	■	0.4	0.68	1.54	TID*075...
DMF078	7.8	3.58	●	■	0.4	0.68	1.54	TID*075...
DMF079	7.9	3.58	●	■	0.4	0.68	1.54	TID*075...
DMF080	8	4.39	●	■	0.7	1.09	2.44	TID*080...
DMF081	8.1	4.39	●	■	0.7	1.09	2.44	TID*080...
DMF082	8.2	4.39	●	■	0.7	1.09	2.44	TID*080...
DMF083	8.3	4.39	●	■	0.7	1.09	2.44	TID*080...
DMF084	8.4	4.39	●	■	0.7	1.09	2.44	TID*080...
DMF085	8.5	4.39	●	■	0.7	1.09	2.44	TID*085...
DMF086	8.6	4.39	●	■	0.7	1.09	2.44	TID*085...
DMF087	8.7	4.39	●	■	0.7	1.09	2.44	TID*085...
DMF088	8.8	4.39	●	■	0.7	1.09	2.44	TID*085...
DMF089	8.9	4.39	●	■	0.7	1.09	2.44	TID*085...
DMF090	9	4.61	●	■	0.7	1.11	2.55	TID*090...
DMF091	9.1	4.61	●	■	0.7	1.11	2.55	TID*090...
DMF092	9.2	4.61	●	■	0.7	1.11	2.55	TID*090...
DMF093	9.3	4.61	●	■	0.7	1.11	2.55	TID*090...
DMF094	9.4	4.61	●	■	0.7	1.11	2.55	TID*090...
DMF095	9.5	4.61	●	■	0.7	1.11	2.55	TID*095...
DMF096	9.6	4.61	●	■	0.7	1.11	2.55	TID*095...
DMF097	9.7	4.61	●	■	0.7	1.11	2.55	TID*095...
DMF098	9.8	4.61	●	■	0.7	1.11	2.55	TID*095...
DMF099	9.9	4.61	●	■	0.7	1.11	2.55	TID*095...
DMF100	10	4.72	●	■	0.7	1.17	2.89	TID*100...
DMF101	10.1	4.72	●	■	0.7	1.17	2.89	TID*100...
DMF103	10.3	4.72	●	■	0.7	1.17	2.89	TID*100...
DMF104	10.4	4.72	●	■	0.7	1.17	2.89	TID*100...
DMF105	10.5	4.72	●	■	0.7	1.17	2.89	TID*105...
DMF106	10.6	4.72	●	■	0.7	1.17	2.89	TID*105...
DMF107	10.7	4.72	●	■	0.7	1.17	2.89	TID*105...
DMF108	10.8	4.72	●	■	0.7	1.17	2.89	TID*105...
DMF110	11	4.9	●	■	0.7	1.25	2.98	TID*110...
DMF115	11.5	4.9	●	■	0.7	1.25	2.98	TID*115...
DMF117	11.7	4.9	●	■	0.7	1.25	2.98	TID*115...
DMF120	12	5.21	●	■	0.7	1.26	3.13	TID*120...
DMF121	12.1	5.21	●	■	0.7	1.26	3.13	TID*120...

Designation	DC	LPR	Coated		SDL	PL	PDD	Body
			AH9130	■				
DMF122	12.2	5.21	●	■	0.7	1.26	3.13	TID*120...
DMF123	12.3	5.21	●	■	0.7	1.26	3.13	TID*120...
DMF124	12.4	5.21	●	■	0.7	1.26	3.13	TID*120...
DMF125	12.5	5.21	●	■	0.7	1.26	3.13	TID*125...
DMF126	12.6	5.21	●	■	0.7	1.26	3.13	TID*125...
DMF127	12.7	5.21	●	■	0.7	1.26	3.13	TID*125...
DMF130	13	5.53	●	■	0.7	1.28	3.52	TID*130...
DMF131	13.1	5.53	●	■	0.7	1.28	3.52	TID*130...
DMF133	13.3	5.53	●	■	0.7	1.28	3.52	TID*130...
DMF135	13.5	5.53	●	■	0.7	1.28	3.52	TID*135...
DMF137	13.7	5.53	●	■	0.7	1.28	3.52	TID*135...
DMF138	13.8	5.53	●	■	0.7	1.28	3.52	TID*135...
DMF139	13.9	5.53	●	■	0.7	1.28	3.52	TID*135...
DMF140	14	5.96	●	■	0.7	1.31	3.81	TID*140...
DMF141	14.1	5.96	●	■	0.7	1.31	3.81	TID*140...
DMF142	14.2	5.96	●	■	0.7	1.31	3.81	TID*140...
DMF143	14.3	5.96	●	■	0.7	1.31	3.81	TID*140...
DMF144	14.4	5.96	●	■	0.7	1.31	3.81	TID*140...
DMF145	14.5	5.96	●	■	0.7	1.31	3.81	TID*145...
DMF150	15	6.43	●	■	0.7	1.35	4.24	TID*150...
DMF152	15.2	6.43	●	■	0.7	1.35	4.24	TID*150...
DMF155	15.5	6.43	●	■	0.7	1.35	4.24	TID*150...
DMF157	15.7	6.43	●	■	0.7	1.35	4.24	TID*150...
DMF158	15.8	6.43	●	■	0.7	1.35	4.24	TID*150...
DMF160	16	6.84	●	■	0.7	1.39	4.06	TID*160...
DMF161	16.1	6.84	●	■	0.7	1.39	4.06	TID*160...
DMF165	16.5	6.84	●	■	0.7	1.39	4.06	TID*160...
DMF167	16.7	6.84	●	■	0.7	1.39	4.06	TID*160...
DMF170	17	7.15	●	■	0.7	1.4	4.14	TID*170...
DMF175	17.5	7.15	●	■	0.7	1.4	4.14	TID*170...
DMF179	17.9	7.15	●	■	0.7	1.4	4.14	TID*170...
DMF180	18	7.45	●	■	0.7	1.42	4.16	TID*180...
DMF185	18.5	7.45	●	■	0.7	1.42	4.16	TID*180...
DMF190	19	7.79	●	■	0.7	1.44	4.25	TID*190...
DMF195	19.5	7.79	●	■	0.7	1.44	4.25	TID*190...
DMF198	19.8	7.79	●	■	0.7	1.44	4.25	TID*190...
DMF200	20	9.12	●	■	0.7	1.77	6.56	TID*200...
DMF205	20.5	9.12	●	■	0.7	1.77	6.56	TID*200...
DMF210	21	9.54	●	■	0.7	1.79	6.92	TID*210...
DMF215	21.5	9.54	●	■	0.7	1.79	6.92	TID*210...
DMF218	21.8	9.54	●	■	0.7	1.79	6.92	TID*210...
DMF220	22	9.86	●	■	0.7	1.81	7.13	TID*220...
DMF225	22.5	9.86	●	■	0.7	1.81	7.13	TID*220...
DMF230	23	10.28	●	■	0.7	1.83	7.42	TID*230...
DMF235	23.5	10.28	●	■	0.7	1.83	7.42	TID*230...
DMF240	24	10.71	●	■	0.7	1.86	7.45	TID*240...
DMF245	24.5	10.71	●	■	0.7	1.86	7.45	TID*240...
DMF250	25	11.15	●	■	0.7	1.9	7.54	TID*250...
DMF254	25.4	11.15	●	■	0.7	1.9	7.54	TID*250...
DMF255	25.5	11.15	●	■	0.7	1.9	7.54	TID*250...
DMF259	25.9	11.15	●	■	0.7	1.9	7.54	TID*250...

ø6 - ø19.9 = 2 pieces per package
ø20 - ø25.9 = 1 piece per package

● : Line up

DMH (High strength cutting edge)

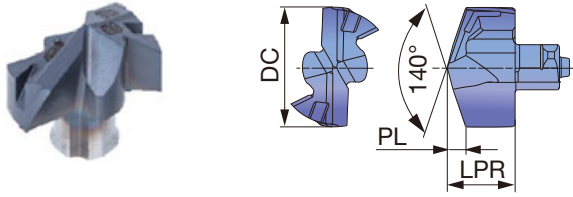

Tool diameter	Head diameter tolerance
ø6 - ø17.9	+0.018 / -0.005
ø18 - ø25.5	+0.021 / -0.005

P	Steel	★		
M	Stainless	★		
K	Cast iron	★		
N	Non-ferrous			
S	Superalloys	★		
H	Hard materials	★		

P	Steel	★		
M	Stainless	★		
K	Cast iron	★		
N	Non-ferrous			
S	Superalloys	★		
H	Hard materials	★		

★ : First choice

Designation	DC	LPR	Coated		PL	Body
			AH9130			
DMH060	6	3.85	●		1.09	TID*060...
DMH068	6.8	4.15	●		1.33	TID*065...
DMH070	7	4.45	●		1.03	TID*070...
DMH075	7.5	4.45	●		1.12	TID*075...
DMH080	8	5.25	●		1.2	TID*080...
DMH085	8.5	5.25	●		1.29	TID*085...
DMH086	8.6	5.25	●		1.31	TID*085...
DMH087	8.7	5.25	●		1.33	TID*085...
DMH088	8.8	5.25	●		1.35	TID*085...
DMH090	9	5.65	●		1.37	TID*090...
DMH095	9.5	5.65	●		1.46	TID*095...
DMH097	9.7	5.65	●		1.5	TID*095...
DMH100	10	6.05	●		1.47	TID*100...
DMH101	10.1	6.05	●		1.49	TID*100...
DMH103	10.3	6.05	●		1.52	TID*100...
DMH104	10.4	6.05	●		1.54	TID*100...
DMH105	10.5	6.05	●		1.56	TID*105...
DMH106	10.6	6.05	●		1.58	TID*105...
DMH107	10.7	6.05	●		1.6	TID*105...
DMH108	10.8	6.05	●		1.62	TID*105...
DMH110	11	6.45	●		1.67	TID*110...
DMH111	11.1	6.45	●		1.69	TID*110...
DMH112	11.2	6.45	●		1.71	TID*110...
DMH113	11.3	6.45	●		1.72	TID*110...
DMH114	11.4	6.45	●		1.74	TID*110...
DMH115	11.5	6.45	●		1.76	TID*115...
DMH117	11.7	6.45	●		1.8	TID*115...
DMH118	11.8	6.45	●		1.82	TID*115...
DMH119	11.9	6.45	●		1.83	TID*115...
DMH120	12	6.8	●		1.82	TID*120...
DMH121	12.1	6.8	●		1.84	TID*120...
DMH122	12.2	6.8	●		1.86	TID*120...
DMH123	12.3	6.8	●		1.87	TID*120...
DMH124	12.4	6.8	●		1.89	TID*120...
DMH125	12.5	6.8	●		1.91	TID*125...
DMH126	12.6	6.8	●		1.93	TID*125...
DMH127	12.7	6.8	●		1.95	TID*125...
DMH128	12.8	6.8	●		1.97	TID*125...
DMH129	12.9	6.8	●		1.98	TID*125...
DMH130	13	7.4	●		1.96	TID*130...
DMH131	13.1	7.4	●		1.98	TID*130...
DMH132	13.2	7.4	●		2	TID*130...
DMH133	13.3	7.4	●		2.01	TID*130...
DMH134	13.4	7.4	●		2.03	TID*130...
DMH135	13.5	7.4	●		2.05	TID*135...
DMH136	13.6	7.4	●		2.07	TID*135...
DMH137	13.7	7.4	●		2.09	TID*135...
DMH138	13.8	7.4	●		2.11	TID*135...
DMH139	13.9	7.4	●		2.12	TID*135...
DMH140	14	7.95	●		2.12	TID*140...
DMH141	14.1	7.95	●		2.14	TID*140...
DMH142	14.2	7.95	●		2.16	TID*140...
DMH143	14.3	7.95	●		2.17	TID*140...

Designation	DC	LPR	Coated		PL	Body
			AH9130			
DMH144	14.4	7.95	●		2.19	TID*140...
DMH145	14.5	7.95	●		2.21	TID*145...
DMH146	14.6	7.95	●		2.23	TID*145...
DMH147	14.7	7.95	●		2.25	TID*145...
DMH150	15	8.53	●		2.27	TID*150...
DMH151	15.1	8.53	●		2.29	TID*150...
DMH152	15.2	8.53	●		2.31	TID*150...
DMH153	15.3	8.53	●		2.32	TID*150...
DMH154	15.4	8.53	●		2.34	TID*150...
DMH155	15.5	8.53	●		2.36	TID*150...
DMH156	15.6	8.53	●		2.38	TID*150...
DMH157	15.7	8.53	●		2.40	TID*150...
DMH158	15.8	8.53	●		2.42	TID*150...
DMH160	16	9.1	●		2.42	TID*160...
DMH162	16.2	9.1	●		2.46	TID*160...
DMH163	16.3	9.1	●		2.47	TID*160...
DMH165	16.5	9.1	●		2.51	TID*160...
DMH166	16.6	9.1	●		2.53	TID*160...
DMH167	16.7	9.1	●		2.55	TID*160...
DMH170	17	9.7	●		2.59	TID*170...
DMH171	17.1	9.7	●		2.61	TID*170...
DMH175	17.5	9.7	●		2.68	TID*170...
DMH177	17.7	9.7	●		2.72	TID*170...
DMH178	17.8	9.7	●		2.74	TID*170...
DMH179	17.9	9.7	●		2.75	TID*170...
DMH180	18	10.3	●		2.73	TID*180...
DMH181	18.1	10.3	●		2.75	TID*180...
DMH183	18.3	10.3	●		2.78	TID*180...
DMH185	18.5	10.3	●		2.82	TID*180...
DMH187	18.7	10.3	●		2.86	TID*180...
DMH190	19	10.8	●		2.88	TID*190...
DMH191	19.1	10.8	●		2.90	TID*190...
DMH192	19.2	10.8	●		2.92	TID*190...
DMH193	19.3	10.8	●		2.93	TID*190...
DMH194	19.4	10.8	●		2.95	TID*190...
DMH195	19.5	10.8	●		2.97	TID*190...
DMH196	19.6	10.8	●		2.99	TID*190...
DMH197	19.7	10.8	●		3.01	TID*190...
DMH200	20	11.4	●		3.02	TID*200...
DMH205	20.5	11.4	●		3.11	TID*200...
DMH210	21	11.98	●		3.18	TID*210...
DMH215	21.5	11.98	●		3.27	TID*210...
DMH220	22	12.56	●		3.32	TID*220...
DMH225	22.5	12.56	●		3.41	TID*220...
DMH230	23	13.13	●		3.46	TID*230...
DMH235	23.5	13.13	●		3.55	TID*230...
DMH240	24	13.7	●		3.62	TID*240...
DMH245	24.5	13.7	●		3.71	TID*240...
DMH250	25	14.3	●		3.8	TID*250...
DMH255	25.5	14.3	●		3.89	TID*250...

ø6 - ø19.9 = 2 pieces per package
 ø20 - ø25.5 = 1 piece per package

● : Line up



DMN (Non-ferrous metals drilling)

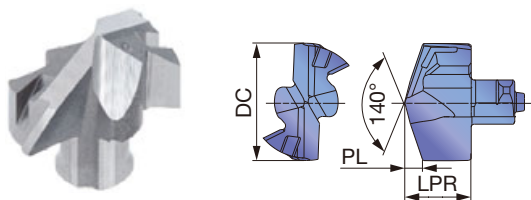

Tool diameter	Head diameter tolerance
ø10 - ø17.5	+0.01 / 0
ø18 - ø19.9	+0.012 / 0

P	Steel			
M	Stainless			
K	Cast iron			
N	Non-ferrous	★		
S	Superalloys			
H	Hard materials			

★ : First choice
☆ : Second choice

Designation	DC	LPR	Coated		PL	Body
			KS15F			
DMN100	10	6.05	●		1.47	TID*100...
DMN102	10.2	6.05	●		1.51	TID*100...
DMN105	10.5	6.05	●		1.56	TID*105...
DMN108	10.8	6.05	●		1.62	TID*105...
DMN110	11	6.45	●		1.67	TID*110...
DMN115	11.5	6.45	●		1.76	TID*115...
DMN120	12	6.8	●		1.82	TID*120...
DMN123	12.3	6.8	●		1.87	TID*120...
DMN125	12.5	6.8	●		1.91	TID*125...
DMN126	12.6	6.8	●		1.93	TID*125...
DMN127	12.7	6.8	●		1.95	TID*125...
DMN130	13	7.4	●		1.96	TID*130...
DMN135	13.5	7.4	●		2.05	TID*135...
DMN138	13.8	7.4	●		2.11	TID*135...
DMN140	14	7.95	●		2.12	TID*140...
DMN142	14.2	7.95	●		2.16	TID*140...
DMN145	14.5	7.95	●		2.21	TID*145...
DMN150	15	8.53	●		2.27	TID*150...
DMN152	15.2	8.53	●		2.31	TID*150...
DMN155	15.5	8.53	●		2.36	TID*150...
DMN158	15.8	8.53	●		2.42	TID*150...
DMN159	15.9	8.53	●		2.43	TID*150...
DMN160	16	9.1	●		2.42	TID*160...
DMN163	16.3	9.1	●		2.47	TID*160...
DMN165	16.5	9.1	●		2.51	TID*160...
DMN170	17	9.7	●		2.59	TID*170...
DMN175	17.5	9.7	●		2.68	TID*170...
DMN180	18	10.3	●		2.73	TID*180...
DMN185	18.5	10.3	●		2.82	TID*180...
DMN190	19	10.8	●		2.88	TID*190...
DMN195	19.5	10.8	●		2.97	TID*190...

ø10 - ø19.5 = 2 pieces per package

● : Line up

STANDARD CUTTING CONDITIONS

ISO	Workpiece material	Hardness	Cutting speed Vc (m/min)	Feed: f (mm/rev)									
				Tool diameter: DC (mm)									
				ø4 - 4.4	ø4.5 - 4.9	ø5 - 5.9	ø6 - 7.9	ø8 - 9.9	ø10 - ø11.9	ø12 - ø13.9	ø14 - ø15.9	ø16 - ø19.9	ø20 - ø25.9
P	Low carbon steels (C < 0.3) SS400, SM490, S25C, etc. C15E4, E275A, E355D, etc.	- 200 HB	80 - 140	0.04 - 0.07	0.04 - 0.08	0.07 - 0.13	0.09 - 0.13	0.12 - 0.25	0.15 - 0.28	0.18 - 0.3	0.20 - 0.35	0.25 - 0.45	0.25 - 0.45
	High carbon steels (C > 0.3) S45C, S55C, etc. C45, C55, etc.	- 300 HB	70 - 120	0.04 - 0.07	0.04 - 0.08	0.07 - 0.13	0.09 - 0.13	0.12 - 0.25	0.15 - 0.28	0.18 - 0.3	0.2 - 0.35	0.25 - 0.45	0.25 - 0.45
	Low alloy steels SCM415, etc. 18CrMo4, etc.	- 200 HB	70 - 120	0.04 - 0.06	0.05 - 0.08	0.07 - 0.13	0.08 - 0.13	0.11 - 0.25	0.14 - 0.28	0.16 - 0.32	0.18 - 0.35	0.23 - 0.4	0.25 - 0.45
	Alloy steels SCM440, SCr420, etc. 42CrMo4, 20Cr4, etc.	- 300 HB	40 - 90	0.04 - 0.07	0.05 - 0.08	0.07 - 0.13	0.08 - 0.13	0.11 - 0.25	0.14 - 0.28	0.16 - 0.32	0.18 - 0.35	0.23 - 0.4	0.25 - 0.45
M	Stainless steels SUS304, SUS316, etc. X5CrNi18-9, X5CrNiMo17-12-2, etc.	- 250 HB	30 - 70	-	-	0.04 - 0.08	0.08 - 0.1	0.1 - 0.15	0.12 - 0.18	0.14 - 0.2	0.16 - 0.24	0.16 - 0.26	0.18 - 0.3
K	Grey cast irons FC250, etc. GG25, etc.	150 - 250 HB	80 - 180	0.04 - 0.08	0.04 - 0.08	0.1 - 0.15	0.12 - 0.18	0.15 - 0.3	0.20 - 0.35	0.25 - 0.4	0.3 - 0.45	0.35 - 0.55	0.35 - 0.6
	Ductile cast irons FCD700, etc. GGG70, etc.	150 - 250 HB	80 - 140	0.04 - 0.08	0.04 - 0.08	0.1 - 0.15	0.12 - 0.18	0.15 - 0.3	0.20 - 0.35	0.25 - 0.4	0.3 - 0.45	0.35 - 0.55	0.35 - 0.6
N	Aluminium alloys ADC12, etc. AlSi11Cu3, etc.	-	80 - 220	-	-	-	0.1 - 0.2	0.2 - 0.35	0.25 - 0.4	0.3 - 0.45	0.35 - 0.5	0.4 - 0.6	0.5 - 0.75
S	Titanium alloys Ti-6Al-4V, etc.	- 40 HRC	20 - 50	-	-	-	0.05 - 0.07	0.06 - 0.12	0.08 - 0.15	0.1 - 0.28	0.12 - 0.2	0.14 - 0.22	0.18 - 0.27
	Nickel-based alloys	- 40 HRC	20 - 50	-	-	-	0.05 - 0.07	0.06 - 0.11	0.08 - 0.13	0.1 - 0.15	0.12 - 0.18	0.12 - 0.22	0.14 - 0.22
H	Hardened steel	- 50 HRC	20 - 50	-	-	-	0.05 - 0.07	0.06 - 0.12	0.08 - 0.15	0.1 - 0.18	0.12 - 0.2	0.14 - 0.22	0.16 - 0.25

- Cutting conditions in the above table show standard cutting conditions
- Cutting conditions may change due to the rigidity and power of the machine and the workpiece material
- Machined hole diameter may change depending upon the rigidity of the machine tool or cutting conditions

Over 2xD drilling without internal coolant

At without internal coolant environment, external coolant supply is required. The cutting condition is recommended to reduced from listed condition depend on material and hole depth. Over 2xD drill, Step or pecking cycle operation is recommended in order to cooling cutting edge and chip evacuation.

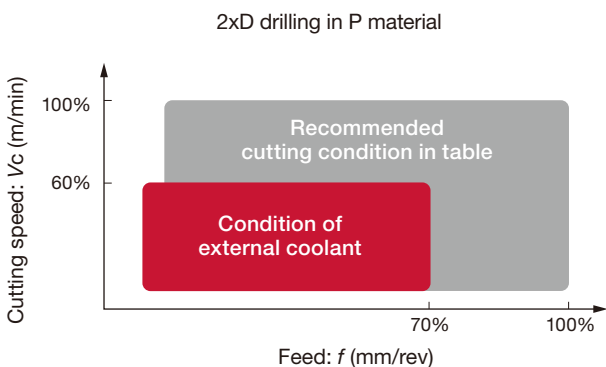

Over 8xD drilling

Drilling operation with over 8xD drilling require stable drill entry. To proof excellent drill entry. DMC head is recommended. Also incase of L/D=8, 12 drilling, the recommended of cutting speed and feeds in between the minimum and medium value listed above at drill entry first few depth. After drill entry, possible to increase feed depend on target productivity.

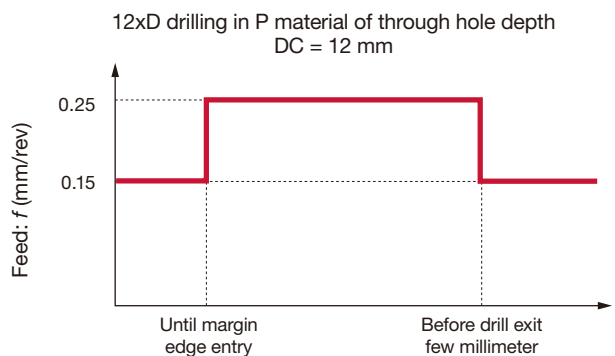

CRITERIA FOR THE END OF DRILL-BODY LIFE

For your safety, it is recommended to replace drill bodies that reached the fatigue life with new drill bodies. For measuring un-clamping torque, the exclusive Clamping key (sold separately) should be used. To determine the fatigue life, Measure the torque value required to unlock the drill head with a torque driver. When the torque value required is equal to or smaller than the values listed below for respective head sizes, replace the drill body with a new one.

Clamping key for measuring un-clamping torque:
KHS-TID10-19.99



* The clamping key can be connect with general torque drivers.



Head Designation	Recommended value of un-clamping torque that means usable limit of a drill body	
	(N·m)	(N·cm)
DM*100-109	0.2	20
DM*110-119	0.2	20
DM*120-129	0.25	25
DM*130-139	0.25	25
DM*140-149	0.3	30
DM*150-159	0.3	30
DM*160-169	0.35	35
DM*170-179	0.35	35
DM*180-189	0.4	40
DM*190-199	0.4	40

Exchangeable head drill, L/D = 3, flange type

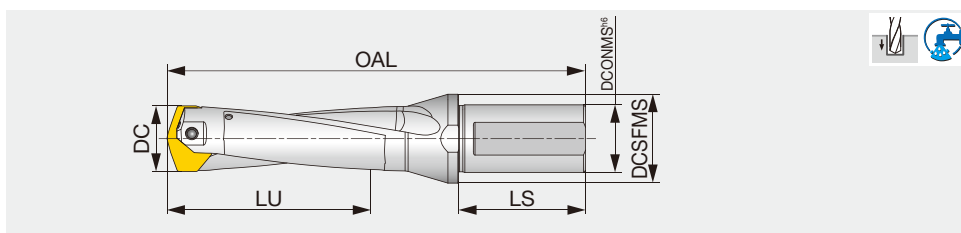

Designation	DC	DCONMS	DCSFMS	LU	LS	OAL		Pocket size	Head
						SMP	SMF		
TIS200F25-3	20 - 20.9	25	32	63.1	56	148.1	148.4	20	SM*20*
TIS210F25-3	21 - 21.9	25	32	66.3	56	151.1	151.4	21	SM*21*
TIS220F25-3	22 - 22.9	25	32	69.4	56	154.4	154.5	22	SM*22*
TIS230F25-3	23 - 23.9	25	32	72.6	56	157.4	157.5	23	SM*23*
TIS240F32-3	24 - 24.9	32	40	75.7	60	170.7	170.7	24	SM*24*
TIS250F32-3	25 - 25.9	32	40	78.9	60	173.7	173.7	25	SM*25*
TIS260F32-3	26 - 26.9	32	40	82	60	177	177.9	26	SM*26*
TIS270F32-3	27 - 27.9	32	40	85.2	60	180	180.9	27	SM*27*
TIS280F32-3	28 - 28.9	32	40	88.4	60	188.4	189.3	28	SM*28*
TIS290F32-3	29 - 29.9	32	40	91.5	60	191.4	-	29	SM*29*
TIS300F32-3	30 - 30.9	32	42	94.7	60	194.7	195.1	30	SM*30*
TIS310F32-3	31 - 31.9	32	42	97.9	60	197.7	198.1	31	SM*31*
TIS320F40-3	32 - 32.9	40	48	101	68	211	211.3	32	SM*32*
TIS330F40-3	33 - 33.9	40	48	104.2	68	214	214.3	33	SM*33*
TIS340F40-3	34 - 34.9	40	48	107.3	68	217	217.3	34	SM*34*
TIS350F40-3	35 - 35.9	40	48	110.4	68	220.4	220.5	35	SM*35*
TIS360F40-3	36 - 36.9	40	48	113.6	68	223.4	223.5	36	SM*36*
TIS370F40-3	37 - 37.9	40	48	116.8	68	226.4	-	37	SM*37*
TIS380F40-3	38 - 38.9	40	50	119.9	68	234.9	-	38	SM*38*
TIS390F40-3	39 - 39.9	40	50	123.1	68	237.9	237.8	39	SM*39*
TIS400F40-3	40 - 41	40	50	126.3	68	240.9	240.8	40	SM*40*

Tool diameter	Hole diameter tolerance*	- An overall length (OAL) differs based on each head geometry.
ø20 - ø29.9	+0.05 / 0	
ø30 - ø41	+0.06 / 0	

*Just for reference

SPARE PARTS



Designation	Clamping screw	Wrench	
		Torx Bit	Grip
TIS200F25-*, TIS210F25-*	TS40178D25	BLDT20/S7	H-TB2W
TIS220F25-*, TIS230F25-*	TS40198D28	BLDT20/S7	H-TB2W
TIS240F32-*, TIS250F32-*	TS40210D3	BLDT20/S7	H-TB2W
TIS260F32-*, TIS270F32-*	TS50230D3	BLDT20/S7	H-TB2W
TIS280F32-*, TIS290F32-*	TS50250D35	BLDT25/S7	H-TB2W
TIS300F32-*, TIS310F32-*	TS60265D4	BLDT25/S7	H-TB2W
TIS320F40-*, TIS330F40-*, TIS340F40-*	TS60285D42	BLDT25/S7	H-TB2W
TIS350F40-*, TIS360F40-*, TIS370F40-*	TS60320D5	BLDT25/S7	H-TB2W
TIS380F40-*, TIS390F40-*, TIS400F40-*	TS80340D6	BLDT25/S7	H-TB2W

Recommended clamping torque (N·m):
 TS40178D25, TS40198D28, TS40210D3 = 4.5,
 TS50230D3 = 5, TS50250D35 = 5.5,
 TS60265D4, TS60285D42, TS60320D5 = 6,
 TS80340D6 = 7

Reference pages: Head → **J037 - J038**
 Standard cutting conditions → **J039**

TIS L/D=5

Exchangeable head drill, L/D = 5, flange type

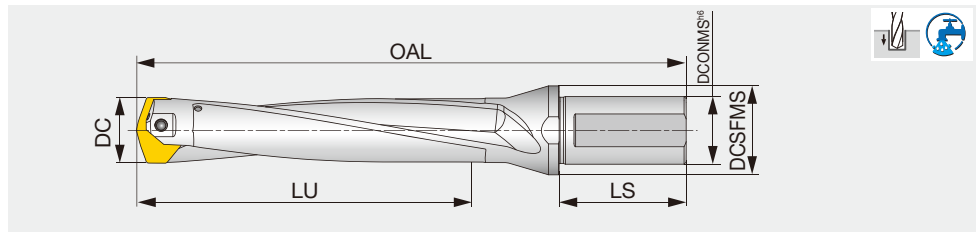

Designation	DC	DCONMS	DCSFMS	LU	LS	OAL			Head
						SMP	SMF	Pocket size	
TIS200F25-5	20 - 20.9	25	32	103.1	56	188.1	188.4	20	SM*20*
TIS210F25-5	21 - 21.9	25	32	108.3	56	193.1	193.4	21	SM*21*
TIS220F25-5	22 - 22.9	25	32	113.4	56	198.4	198.5	22	SM*22*
TIS230F25-5	23 - 23.9	25	32	118.6	56	203.4	203.5	23	SM*23*
TIS240F32-5	24 - 24.9	32	40	123.7	60	218.7	218.7	24	SM*24*
TIS250F32-5	25 - 25.9	32	40	128.9	60	223.7	223.7	25	SM*25*
TIS260F32-5	26 - 26.9	32	40	134	60	229	229.9	26	SM*26*
TIS270F32-5	27 - 27.9	32	40	139.2	60	234	234.9	27	SM*27*
TIS280F32-5	28 - 28.9	32	40	144.4	60	244.4	245.3	28	SM*28*
TIS290F32-5	29 - 29.9	32	40	149.5	60	249.4	-	29	SM*29*
TIS300F32-5	30 - 30.9	32	42	154.7	60	254.7	255.1	30	SM*30*
TIS310F32-5	31 - 31.9	32	42	159.9	60	259.7	260.1	31	SM*31*
TIS320F40-5	32 - 32.9	40	48	165	68	275	275.3	32	SM*32*
TIS330F40-5	33 - 33.9	40	48	170.2	68	280	280.3	33	SM*33*
TIS340F40-5	34 - 34.9	40	48	175.3	68	285	285.3	34	SM*34*
TIS350F40-5	35 - 35.9	40	48	180.4	68	290.4	290.5	35	SM*35*
TIS360F40-5	36 - 36.9	40	48	185.6	68	295.4	295.5	36	SM*36*
TIS370F40-5	37 - 37.9	40	48	190.8	68	300.4	-	37	SM*37*
TIS380F40-5	38 - 38.9	40	50	195.9	68	310.9	-	38	SM*38*
TIS390F40-5	39 - 39.9	40	50	201.1	68	315.9	315.8	39	SM*39*
TIS400F40-5	40 - 41	40	50	206.3	68	320.9	320.8	40	SM*40*

Tool diameter	Hole diameter tolerance*	- An overall length (OAL) differs based on each head geometry.
ø20 - ø29.9	+0.08 / 0	
ø30 - ø41	+0.09 / 0	

*Just for reference

SPARE PARTS



Designation	Clamping screw	Wrench	
		Torx Bit	Grip
TIS200F25-*, TIS210F25-*	TS40178D25	BLDT20/S7	H-TB2W
TIS220F25-*, TIS230F25-*	TS40198D28	BLDT20/S7	H-TB2W
TIS240F32-*, TIS250F32-*	TS40210D3	BLDT20/S7	H-TB2W
TIS260F32-*, TIS270F32-*	TS50230D3	BLDT20/S7	H-TB2W
TIS280F32-*, TIS290F32-*	TS50250D35	BLDT25/S7	H-TB2W
TIS300F32-*, TIS310F32-*	TS60265D4	BLDT25/S7	H-TB2W
TIS320F40-*, TIS330F40-*, TIS340F40-*	TS60285D42	BLDT25/S7	H-TB2W
TIS350F40-*, TIS360F40-*, TIS370F40-*	TS60320D5	BLDT25/S7	H-TB2W
TIS380F40-*, TIS390F40-*, TIS400F40-*	TS80340D6	BLDT25/S7	H-TB2W

Recommended clamping torque (N·m):
 TS40178D25, TS40198D28, TS40210D3 = 4.5,
 TS50230D3 = 5, TS50250D35 = 5.5,
 TS60265D4, TS60285D42, TS60320D5 = 6,
 TS80340D6 = 7

Reference pages: Head → **J037 - J038**
 Standard cutting conditions → **J039**



Exchangeable head drill, L/D = 8, flange type

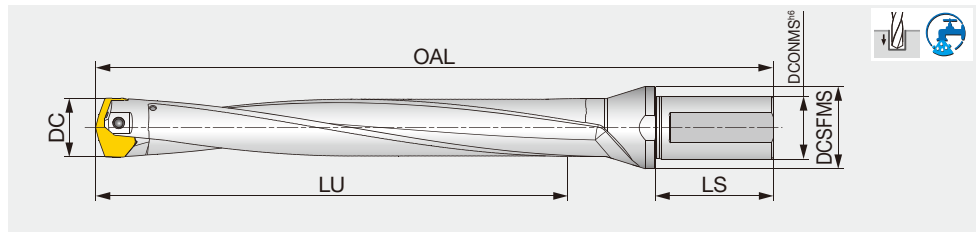

Designation	DC	DCONMS	DCSFMS	LU	LS	OAL			Head
						SMP	SMF	Pocket size	
TIS260F32-8	26 - 26.9	32	40	212	60	307	307.9	26	SM*26*
TIS270F32-8	27 - 27.9	32	40	220.2	60	315	315.9	27	SM*27*
TIS290F32-8	29 - 29.9	32	40	236.5	60	336.4	-	29	SM*29*
TIS300F32-8	30 - 30.9	32	42	244.7	60	344.7	345.1	30	SM*30*
TIS320F40-8	32 - 32.9	40	48	261	68	371.7	372	32	SM*32*
TIS330F40-8	33 - 33.9	40	48	269.2	68	379	379.3	33	SM*33*

Tool diameter	Hole diameter tolerance*	- An overall length (OAL) differs based on each head geometry.
ø26 - ø29.9	+0.08 / 0	
ø30 - ø33.9	+0.09 / 0	

*Just for reference

SPARE PARTS



Designation	Clamping screw	Wrench	
		Torx Bit	Grip
TIS260F32-*, TIS270F32-*	TS50230D3	BLDT20/S7	H-TB2W
TIS290F32-*	TS50250D35	BLDT25/S7	H-TB2W
TIS300F32-*	TS60265D4	BLDT25/S7	H-TB2W
TIS320F40-*, TIS330F40-*	TS60285D42	BLDT25/S7	H-TB2W

Recommended clamping torque (N·m):
 TS50230D3 = 5, TS50250D35 = 5.5,
 TS60265D4, TS60285D42 = 6

● Tips when using 8xD drills

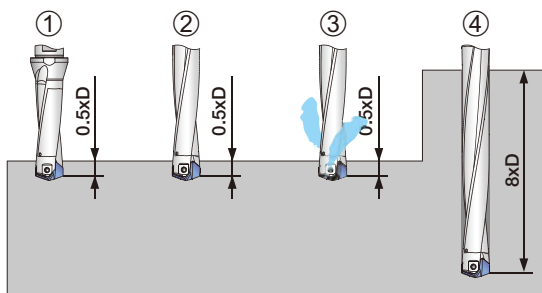

- ① Drill a pilot hole in the depth of 0.5xD (3xD drill body is recommended). The same head diameter should be used for the pre-hole and the main drilling process.
- ② Rotate the drill at a low speed (eg. 100 rpm). While maintaining the drill speed, slowly feed into the pilot hole for several millimeters from the entry.
- ③ Activate the internal coolant and increase the drill rotation to the required speed.
- ④ Drill to the required depth using the recommended cutting parameters.

Reference pages: Head → **J037 - J038**
 Standard cutting conditions → **J039**

DRILL HEAD

SMP (General purpose)

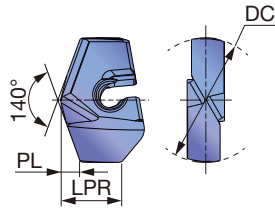

P	Steel	★	★	
M	Stainless	★	★	
K	Cast iron	★	★	
N	Non-ferrous	☆	☆	
S	Superalloys	☆	☆	
H	Hard materials	☆	☆	

★ : First choice
☆ : Second choice

Tool diameter	Head diameter tolerance
ø20 - ø29.9	+0.014 / -0.015
ø30 - ø41	+0.014 / -0.02

P	Steel	★	★	
M	Stainless	★	★	
K	Cast iron	★	★	
N	Non-ferrous	☆	☆	
S	Superalloys	☆	☆	
H	Hard materials	☆	☆	

★ : First choice
☆ : Second choice

Designation	DC	LPR	Coated		PL	Pocket size	Body
			AH9130	AH725			
SMP200	20	9.65	●	●	3.11	20	TIS200F25-*
SMP205	20.5	9.44	●	●	3.2	20	TIS200F25-*
SMP210	21	9.23	●	●	3.29	21	TIS210F25-*
SMP215	21.5	9.02	●	●	3.38	21	TIS210F25-*
SMP220	22	10.54	●	●	3.42	22	TIS220F25-*
SMP222	22.2	10.46	●	●	3.46	22	TIS220F25-*
SMP223	22.3	10.41	●	●	3.47	22	TIS220F25-*
SMP225	22.5	10.33	●	●	3.51	22	TIS220F25-*
SMP230	23	10.12	●	●	3.6	23	TIS230F25-*
SMP235	23.5	9.91	●	●	3.69	23	TIS230F25-*
SMP238	23.8	9.78	●	●	3.75	23	TIS230F25-*
SMP240	24	10.76	●	●	3.73	24	TIS240F32-*
SMP245	24.5	10.55	●	●	3.82	24	TIS240F32-*
SMP247	24.7	10.47	●	●	3.86	24	TIS240F32-*
SMP250	25	10.34	●	●	3.91	25	TIS250F32-*
SMP255	25.5	10.13	●	●	4	25	TIS250F32-*
SMP260	26	11.55	●	●	4.04	26	TIS260F32-*
SMP261	26.1	11.51	●	●	4.06	26	TIS260F32-*
SMP262	26.2	11.47	●	●	4.08	26	TIS260F32-*
SMP263	26.3	11.42	●	●	4.09	26	TIS260F32-*
SMP264	26.4	11.38	●	●	4.11	26	TIS260F32-*
SMP265	26.5	11.34	●	●	4.13	26	TIS260F32-*
SMP266	26.6	11.3	●	●	4.15	26	TIS260F32-*
SMP267	26.7	11.26	●	●	4.17	26	TIS260F32-*
SMP270	27	11.13	●	●	4.22	27	TIS270F32-*
SMP271	27.1	11.09	●	●	4.24	27	TIS270F32-*
SMP272	27.2	11.05	●	●	4.26	27	TIS270F32-*
SMP273	27.3	11	●	●	4.28	27	TIS270F32-*
SMP275	27.5	10.92	●	●	4.31	27	TIS270F32-*
SMP276	27.6	10.88	●	●	4.33	27	TIS270F32-*
SMP280	28	11.74	●	●	4.35	28	TIS280F32-*
SMP281	28.1	11.7	●	●	4.37	28	TIS280F32-*
SMP283	28.3	11.61	●	●	4.4	28	TIS280F32-*
SMP285	28.5	11.53	●	●	4.44	28	TIS280F32-*
SMP286	28.6	11.49	●	●	4.46	28	TIS280F32-*
SMP290	29	11.32	●	●	4.53	29	TIS290F32-*
SMP291	29.1	11.28	●	●	4.55	29	TIS290F32-*
SMP293	29.3	11.19	●	●	4.59	29	TIS290F32-*
SMP295	29.5	11.11	●	●	4.62	29	TIS290F32-*
SMP296	29.6	11.07	●	●	4.64	29	TIS290F32-*
SMP297	29.7	11.03	●	●	4.66	29	TIS290F32-*
SMP298	29.8	10.98	●	●	4.68	29	TIS290F32-*
SMP299	29.9	10.94	●	●	4.7	29	TIS290F32-*
SMP300	30	14.14	●	●	4.67	30	TIS300F32-*
SMP301	30.1	14.1	●	●	4.69	30	TIS300F32-*
SMP302	30.2	14.06	●	●	4.71	30	TIS300F32-*
SMP303	30.3	14.01	●	●	4.72	30	TIS300F32-*
SMP304	30.4	13.97	●	●	4.74	30	TIS300F32-*
SMP305	30.5	13.93	●	●	4.76	30	TIS300F32-*
SMP307	30.7	13.85	●	●	4.8	30	TIS300F32-*
SMP308	30.8	13.8	●	●	4.82	30	TIS300F32-*
SMP310	31	13.72	●	●	4.85	31	TIS310F32-*
SMP311	31.1	13.68	●	●	4.87	31	TIS310F32-*

Designation	DC	LPR	Coated		PL	Pocket size	Body
			AH9130	AH725			
SMP313	31.3	13.59	●	●	4.91	31	TIS310F32-*
SMP315	31.5	13.51	●	●	4.94	31	TIS310F32-*
SMP318	31.8	13.38	●	●	5	31	TIS310F32-*
SMP320	32	14.53	●	●	4.98	32	TIS320F40-*
SMP321	32.1	14.49	●	●	5	32	TIS320F40-*
SMP322	32.2	14.45	●	●	5.02	32	TIS320F40-*
SMP325	32.5	14.32	●	●	5.07	32	TIS320F40-*
SMP328	32.8	14.19	●	●	5.13	32	TIS320F40-*
SMP330	33	14.11	●	●	5.16	33	TIS330F40-*
SMP331	33.1	14.07	●	●	5.18	33	TIS330F40-*
SMP333	33.3	13.98	●	●	5.22	33	TIS330F40-*
SMP335	33.5	13.9	●	●	5.25	33	TIS330F40-*
SMP339	33.9	13.73	●	●	5.33	33	TIS330F40-*
SMP340	34	13.69	●	●	5.34	34	TIS340F40-*
SMP341	34.1	13.65	●	●	5.36	34	TIS340F40-*
SMP343	34.3	13.56	●	●	5.4	34	TIS340F40-*
SMP345	34.5	13.48	●	●	5.44	34	TIS340F40-*
SMP349	34.9	13.31	●	●	5.51	34	TIS340F40-*
SMP350	35	16.56	●	●	5.44	35	TIS350F40-*
SMP351	35.1	16.52	●	●	5.46	35	TIS350F40-*
SMP352	35.2	16.48	●	●	5.48	35	TIS350F40-*
SMP355	35.5	16.35	●	●	5.53	35	TIS350F40-*
SMP357	35.7	16.27	●	●	5.57	35	TIS350F40-*
SMP360	36	16.14	●	●	5.62	36	TIS360F40-*
SMP361	36.1	16.1	●	●	5.64	36	TIS360F40-*
SMP362	36.2	16.06	●	●	5.66	36	TIS360F40-*
SMP365	36.5	15.93	●	●	5.71	36	TIS360F40-*
SMP366	36.6	15.89	●	●	5.73	36	TIS360F40-*
SMP370	37	15.72	●	●	5.8	37	TIS370F40-*
SMP371	37.1	15.68	●	●	5.82	37	TIS370F40-*
SMP373	37.3	15.59	●	●	5.86	37	TIS370F40-*
SMP374	37.4	15.55	●	●	5.88	37	TIS370F40-*
SMP375	37.5	15.51	●	●	5.9	37	TIS370F40-*
SMP380	38	17	●	●	5.91	38	TIS380F40-*
SMP381	38.1	16.96	●	●	5.93	38	TIS380F40-*
SMP383	38.3	16.87	●	●	5.96	38	TIS380F40-*
SMP385	38.5	16.79	●	●	6	38	TIS380F40-*
SMP388	38.8	16.66	●	●	6.06	38	TIS380F40-*
SMP390	39	16.58	●	●	6.09	39	TIS390F40-*
SMP391	39.1	16.54	●	●	6.11	39	TIS390F40-*
SMP395	39.5	16.37	●	●	6.18	39	TIS390F40-*
SMP397	39.7	16.29	●	●	6.22	39	TIS390F40-*
SMP398	39.8	16.24	●	●	6.24	39	TIS390F40-*
SMP400	40	16.16	●	●	6.27	40	TIS400F40-*
SMP401	40.1	16.12	●	●	6.29	40	TIS400F40-*
SMP402	40.2	16.08	●	●	6.31	40	TIS400F40-*
SMP403	40.3	16.03	●	●	6.33	40	TIS400F40-*
SMP405	40.5	15.95	●	●	6.37	40	TIS400F40-*
SMP408	40.8	15.82	●	●	6.42	40	TIS400F40-*
SMP410	41	15.74	●	●	6.46	40	TIS400F40-*

● : Line up
Package quantity = 1 pc



DRILL HEAD

SMF (Flat geometry head)

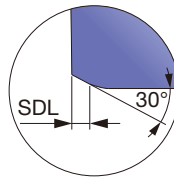
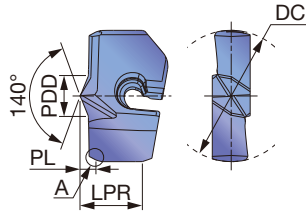
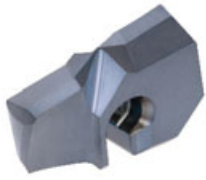

Detail in A

P	Steel	★	
M	Stainless	★	
K	Cast iron	★	
N	Non-ferrous	☆	
S	Superalloys	★	
H	Hard materials	★	

★ : First choice
☆ : Second choice

Tool diameter	Head diameter tolerance
ø20 - ø29.9	+0.014 / -0.015
ø30 - ø41	+0.014 / -0.02

Designation	DC	LPR	Coated		SDL	PL	PDD	Pocket size	Body
			AH9130						
SMF200	20	9.82	●		0.7	2.18	8.3	20	TIS200F25-*
SMF205	20.5	9.61	●		0.7	2.18	8.3	20	TIS200F25-*
SMF210	21	9.4	●		0.7	2.18	8.3	21	TIS210F25-*
SMF215	21.5	9.19	●		0.7	2.18	8.3	21	TIS210F25-*
SMF220	22	10.56	●		0.7	2.38	9	22	TIS220F25-*
SMF225	22.5	10.35	●		0.7	2.38	9	22	TIS220F25-*
SMF227	22.7	10.27	●		0.7	2.38	9	22	TIS220F25-*
SMF230	23	10.14	●		0.7	2.38	9	23	TIS230F25-*
SMF235	23.5	9.93	●		0.7	2.38	9	23	TIS230F25-*
SMF238	23.8	9.8	●		0.7	2.38	9	23	TIS230F25-*
SMF240	24	10.63	●		0.7	2.52	10	24	TIS240F32-*
SMF242	24.2	10.55	●		0.7	2.52	10	24	TIS240F32-*
SMF245	24.5	10.42	●		0.7	2.52	10	24	TIS240F32-*
SMF250	25	10.21	●		0.7	2.52	10	25	TIS250F32-*
SMF255	25.5	10	●		0.7	2.52	10	25	TIS250F32-*
SMF260	26	12.32	●		0.7	2.48	10.5	26	TIS260F32-*
SMF265	26.5	12.11	●		0.7	2.48	10.5	26	TIS260F32-*
SMF270	27	11.9	●		0.7	2.48	10.5	27	TIS270F32-*
SMF275	27.5	11.69	●		0.7	2.48	10.5	27	TIS270F32-*
SMF280	28	12.28	●		0.7	2.72	11.6	28	TIS280F32-*
SMF290	29	11.86	●		0.7	2.72	11.6	29	TIS290F32-*
SMF295	29.5	11.65	●		0.7	2.72	11.6	29	TIS290F32-*
SMF296	29.6	11.61	●		0.7	2.72	11.6	29	TIS290F32-*
SMF300	30	14.46	●		0.7	2.8	12.4	30	TIS300F32-*
SMF310	31	14.04	●		0.7	2.8	12.4	31	TIS310F32-*
SMF315	31.5	13.83	●		0.7	2.8	12.4	31	TIS310F32-*
SMF320	32	14.76	●		0.7	3.13	13.6	32	TIS320F40-*
SMF325	32.5	14.55	●		0.7	3.13	13.6	32	TIS320F40-*
SMF330	33	14.34	●		0.7	3.13	13.6	33	TIS330F40-*
SMF340	34	13.92	●		0.7	3.13	13.6	34	TIS340F40-*
SMF345	34.5	13.71	●		0.7	3.13	13.6	34	TIS340F40-*
SMF350	35	16.54	●		0.7	3.31	14.6	35	TIS350F40-*
SMF355	35.5	16.33	●		0.7	3.31	14.6	35	TIS350F40-*
SMF360	36	16.12	●		0.7	3.31	14.6	36	TIS360F40-*
SMF365	36.5	15.91	●		0.7	3.31	14.6	36	TIS360F40-*
SMF370	37	15.7	●		0.7	3.31	14.6	37	TIS370F40-*
SMF380	38	16.85	●		0.7	3.49	15.9	38	TIS380F40-*
SMF390	39	16.43	●		0.7	3.49	15.9	39	TIS390F40-*
SMF400	40	16.01	●		0.7	3.49	15.9	40	TIS400F40-*
SMF402	40.2	15.93	●		0.7	3.49	15.9	40	TIS400F40-*
SMF410	41	15.59	●		0.7	3.49	15.9	40	TIS400F40-*

No drill body modification is needed when mounting SMF drill head. ●: Line up
Do not regrind. SMF drill heads are not designed for re-use after regrind. Package quantity = 1 pc

Counterbore dimensions for bolt holes

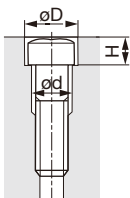

Thread size	M16	M20	M22	M24
øD (mm)	26	32	35	39
H (mm)	17.5	21.5	23.5	25.5
ød (mm)	18	22	24	26
Applicable tool	SMF260	SMF320	SMF350	SMF390

STANDARD CUTTING CONDITIONS

ISO	Workpiece materials	Hardness	Cutting speed V _c (m/min)	Feed: f (mm/rev)		
				ø20 - ø29.9	ø30 - ø35.9	ø36 - ø41
P	Low carbon steel S15C, S20C, etc. C15, C20, etc.	- 200 HB	80 - 140	0.2 - 0.5	0.2 - 0.5	0.2 - 0.55
	Carbon steel and alloy steel S55C, SCM440, etc. C55, 42CrMo4, etc.	- 300 HB	80 - 130	0.2 - 0.5	0.2 - 0.5	0.2 - 0.55
	Prehardend steel NAK80, PX5, etc.	30 - 40 HRC	50 - 100	0.2 - 0.5	0.2 - 0.5	0.2 - 0.55
M	Stainless steel SUS304, SUS316, etc. X5CrNi18-9, X5CrNiMo17-12-3, etc.	-	40 - 80	0.15 - 0.3	0.2 - 0.3	0.2 - 0.35
K	Grey cast iron FC250, FC300, etc. 250, 300, etc.	150 - 250 HB	80 - 180	0.25 - 0.55	0.25 - 0.55	0.3 - 0.6
	Ductile cast iron 400-15, 600-3, etc.	150 - 250 HB	80 - 140	0.25 - 0.55	0.25 - 0.55	0.3 - 0.6
N	Non ferrous materials	-	100 - 200	0.4 - 0.6	0.4 - 0.6	0.5 - 0.7
S	Heat-resistant alloys Inconel718, etc.	- 40 HRC	20 - 50	0.1 - 0.2	0.1 - 0.2	0.1 - 0.25
	Titanium alloys Ti-6Al-4V, etc.	- 40 HRC	20 - 50	0.1 - 0.2	0.1 - 0.2	0.1 - 0.25
H	Hardened materials	- 50 HRC	20 - 60	0.1 - 0.2	0.1 - 0.2	0.1 - 0.25

TAILOR MADE DRILL BODY

Special drill bodies featuring chamfering or counter boring capabilities with indexable insert and head. Reduce down time and tool management compared to solid drill.

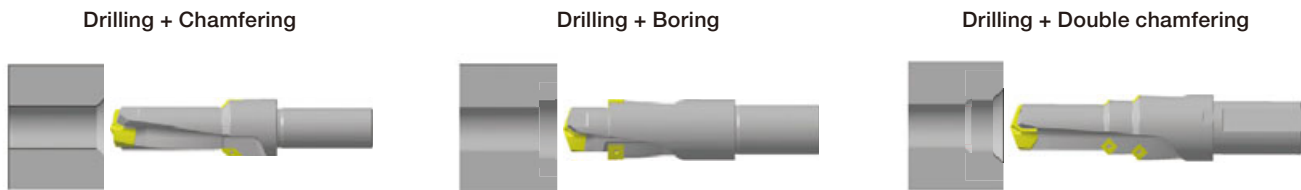

REGRINDING HOLDER

SMP-GH

Regrinding holder for SMP drill heads

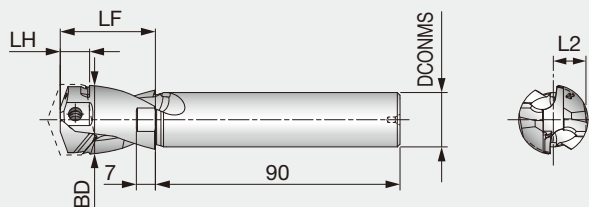

Designation	DCONMS	BD	LF	LH	L2	Pocket size	Head
SMP260-279-GH	20	25.5	35	10.8	12	26, 27	SMP260-SMP279
SMP280-299-GH	20	27.5	35	10.8	13	28, 29	SMP280-SMP299
SMP300-319-GH	20	29.5	35	13	14	30, 31	SMP300-SMP319
SMP320-349-GH	20	31.5	35	13	15	32, 33, 34	SMP320-SMP349
SMP350-379-GH	20	34.5	40	14.7	16.5	35, 36, 37	SMP350-SMP379
SMP380-410-GH	20	37.5	40	15.1	18	38, 39, 40	SMP380-SMP410

The exclusive holders with short length for regrinding of SMP heads .

● Cautions when regrinding SMP drill heads

Note: SMF drill heads are not recommended to be reground due to little regrinding allowance.

① Clamping

- Assemble the drill head on the regrinding holder or shortest standard holder (3xD)
- Set-up the drill head in the machine : Total run-out must be less than 0.02 mm

② Grinding the 1st clearance angle

- Set the drill for point angle (140°) and 1st clearance angle (8°)
- Keep the cutting edge in the horizontal plane

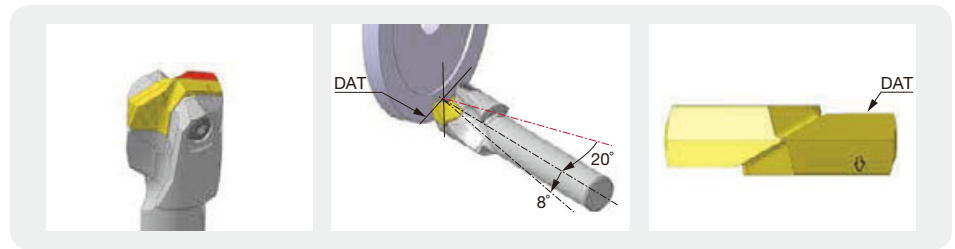

③ Grinding the 2nd clearance angle

- Set the drill for 2nd clearance angle (15°)

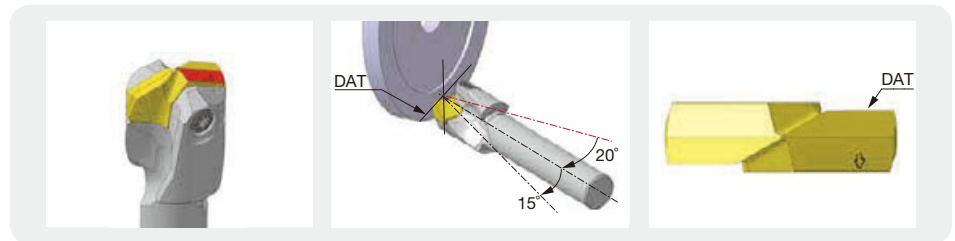

④ Grinding the chisel (Thinning)

- Set the drill for thinning angle (35°) with reference to drill axis and angle (30°) with reference to radial axis
- Keep the chisel thickness (0.14 - 0.2 mm) and the thinning point must be over the center line

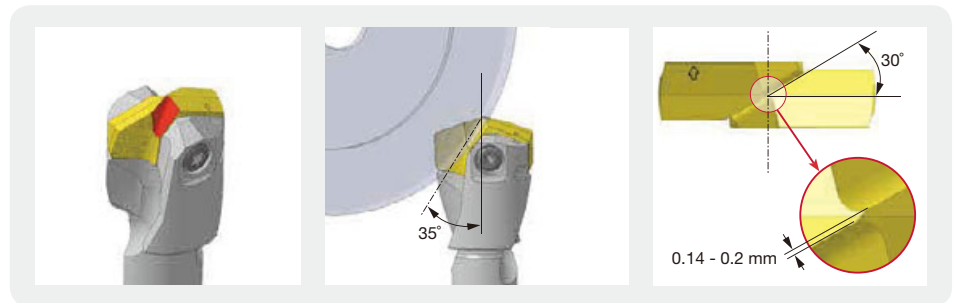

⑤ Edge preparation (Honing)

- Cutting edges should have honing by sand or brush (0.04 - 0.06 mm)
- Nega-land by diamond hand lapper is also available
- The width of honing must be uniform with good surface finish

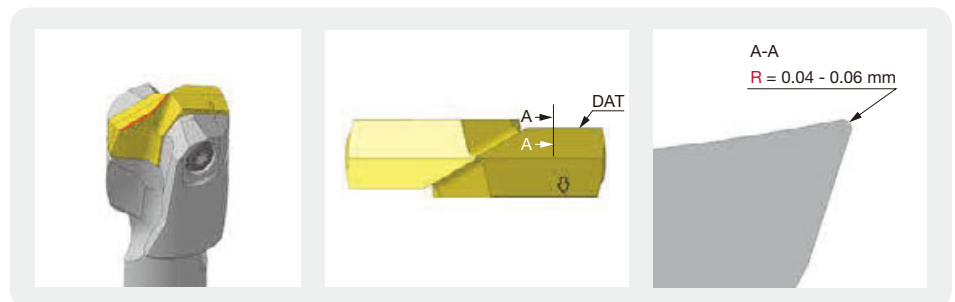

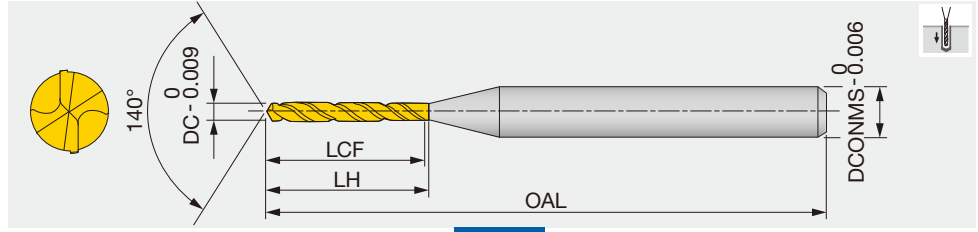

Designation	DC	Coated		DCONMS	LCF	LH	OAL	Designation	DC	Coated		DCONMS	LCF	LH	OAL
		YH170	YH180							YH170	YH180				
DSM0010G10	0.1	●		3	1.15	1.4	38	DSM0100G10	1	●		3	11.5	12.1	38
DSM0011G10	0.11	●		3	1.25	1.5	38	DSM0108G05	1.08	●		3	8	8.6	38
DSM0012G10	0.12	●		3	1.35	1.6	38	DSM0110G05	1.1	●		3	8	8.6	38
DSM0013G10	0.13	●		3	1.55	1.8	38	DSM0120G05	1.2	●		3	8.9	9.5	38
DSM0014G10	0.14	●		3	1.65	1.9	38	DSM0130G05	1.3	●		3	9.7	10.3	38
DSM0015G10	0.15	●		3	1.75	2	38	DSM0140G05	1.4	●		3	10.5	11.1	38
DSM0016G10	0.16	●		3	1.85	2.1	38	DSM0145G05	1.45	●		3	11.3	11.9	38
DSM0017G10	0.17	●		3	1.95	2.2	38	DSM0149G05	1.49	●		3	11.3	11.9	38
DSM0018G10	0.18	●		3	2.15	2.4	38	DSM0150G05	1.5	●		3	11.3	11.9	38
DSM0019G10	0.19	●		3	2.25	2.5	38	DSM0153G05	1.53	●		3	12.1	12.7	45
DSM0020G10	0.2	●		3	2.35	2.6	38	DSM0155G05	1.55	●		3	12.1	12.7	45
DSM0021G10	0.21	●		3	2.45	2.7	38	DSM0160G05	1.6	●		3	12.1	12.7	45
DSM0022G10	0.22	●		3	2.55	2.8	38	DSM0165G05	1.65	●		3	12.9	13.6	45
DSM0023G10	0.23	●		3	2.75	3	38	DSM0170G05	1.7	●		3	12.9	13.6	45
DSM0024G10	0.24	●		3	2.85	3.1	38	DSM0180G05	1.8	●		3	13.7	14.3	45
DSM0025G10	0.25	●		3	3	3.3	38	DSM0182G05	1.82	●		3	14.5	15.1	45
DSM0026G10	0.26	●		3	3.1	3.4	38	DSM0185G05	1.85	●		3	14.5	15.1	45
DSM0027G10	0.27	●		3	3.2	3.5	38	DSM0190G05	1.9	●		3	14.5	15.1	45
DSM0028G10	0.28	●		3	3.4	3.7	38	DSM0195G05	1.95	●		3	15.3	15.9	45
DSM0029G10	0.29	●		3	3.5	3.8	38	DSM0200G05	2		●	3	15.3	15.9	45
DSM0030G10	0.3	●		3	3.9	4.2	38	DSM0203G05	2.03		●	3	16.1	16.7	45
DSM0031G15	0.31	●		3	5.6	5.9	38	DSM0205G05	2.05		●	3	16.1	16.7	45
DSM0032G15	0.32	●		3	5.6	5.9	38	DSM0210G05	2.1		●	3	16.1	16.7	45
DSM0033G15	0.33	●		3	5.6	5.9	38	DSM0220G05	2.2		●	3	16.9	17.5	45
DSM0034G15	0.34	●		3	5.6	5.9	38	DSM0230G05	2.3		●	3	17.7	18.3	45
DSM0035G15	0.35	●		3	5.6	5.9	38	DSM0240G05	2.4		●	3	18.5	19.1	55
DSM0036G15	0.36	●		3	6.5	6.8	38	DSM0250G05	2.5		●	3	19.3	19.9	55
DSM0037G15	0.37	●		3	6.5	6.8	38	DSM0254G05	2.54		●	3	20.1	20.7	55
DSM0038G15	0.38	●		3	6.5	6.8	38	DSM0255G05	2.55		●	3	20.1	20.7	55
DSM0039G15	0.39	●		3	6.5	6.8	38	DSM0256G05	2.56		●	3	20.1	20.7	55
DSM0040G15	0.4	●		3	6.5	6.8	38	DSM0257G05	2.57		●	3	20.1	20.7	55
DSM0041G15	0.41	●		3	7.4	7.7	38	DSM0260G05	2.6		●	3	20.1	20.7	55
DSM0042G15	0.42	●		3	7.4	7.7	38	DSM0265G05	2.65		●	3	20.9	21.5	55
DSM0043G15	0.43	●		3	7.4	7.7	38	DSM0270G05	2.7		●	3	20.9	21.5	55
DSM0044G15	0.44	●		3	7.4	7.7	38	DSM0280G05	2.8		●	3	21.7	22.3	55
DSM0045G15	0.45	●		3	7.4	7.7	38	DSM0290G05	2.9		●	3	22.5	23.1	55
DSM0046G15	0.46	●		3	8.1	8.7	38	DSM0295G05	2.95		●	3	23.3	23.9	55
DSM0047G15	0.47	●		3	8.1	8.7	38	DSM0296G05	2.96		●	3	23.3	23.9	55
DSM0048G15	0.48	●		3	8.1	8.7	38	DSM0300G05	3		●	3	23.3	23.9	55
DSM0049G15	0.49	●		3	8.1	8.7	38								
DSM0050G15	0.5	●		3	8.1	8.7	38								
DSM0053G10	0.53	●		3	6.6	7.2	38								
DSM0055G10	0.55	●		3	6.6	7.2	38								
DSM0060G10	0.6	●		3	7.3	7.9	38								
DSM0061G10	0.61	●		3	7.9	8.5	38								
DSM0065G10	0.65	●		3	7.9	8.5	38								
DSM0070G10	0.7	●		3	8.6	9.2	38								
DSM0075G10	0.75	●		3	9.2	9.8	38								
DSM0080G10	0.8	●		3	9.9	10.5	38								
DSM0088G10	0.88	●		3	9.9	10.5	38								
DSM0090G10	0.9	●		3	9.9	10.5	38								
DSM0097G10	0.97	●		3	11	11.6	38								

● : Line up

STANDARD CUTTING CONDITIONS

ISO	Workpiece material	Hardness	Cutting speed: Vc (m/min)			Feed: f (mm/rev)				
			ø0.1 ~ ø0.3	ø0.3 ~ ø0.5	ø0.5 ~ ø3	ø0.1 ~ ø0.3	ø0.3 ~ ø0.5	ø0.5 ~ ø1	ø1 ~ ø2	ø2 ~ ø3
P	Carbon steels, Alloy steels	- 300 HB	5 - 20	15 - 30	25 - 60	0.001 - 0.004	0.002 - 0.01	0.005 - 0.05	0.03 - 0.09	0.05 - 0.1
M	Stainless steels	- 200 HB	2 - 12	6 - 18	10 - 20	0.0005 - 0.004	0.002 - 0.008	0.005 - 0.03	0.01 - 0.04	0.02 - 0.05
K	Grey cast irons	150 - 250 HB	5 - 15	10 - 25	20 - 50	0.0005 - 0.004	0.002 - 0.012	0.005 - 0.03	0.01 - 0.06	0.03 - 0.12
	Ductile cast irons	150 - 250 HB	5 - 15	10 - 25	20 - 50	0.001 - 0.003	0.002 - 0.01	0.005 - 0.02	0.01 - 0.05	0.03 - 0.1
N	Aluminium alloys	-	10 - 20	10 - 30	20 - 50	0.001 - 0.01	0.005 - 0.03	0.01 - 0.05	0.04 - 0.15	0.06 - 0.2
	Copper / Brass	-	10 - 20	10 - 30	20 - 50	0.001 - 0.01	0.005 - 0.03	0.01 - 0.05	0.04 - 0.15	0.06 - 0.2
S	Heat-resistant alloys	- 40 HRC	2 - 6	5 - 10	8 - 20	0.0005 - 0.003	0.002 - 0.004	0.002 - 0.004	0.002 - 0.004	※
H	High hardened steels	- 50 HRC	4 - 8	6 - 10	6 - 16	0.0005 - 0.002	0.001 - 0.005	0.005 - 0.02	0.01 - 0.03	0.02 - 0.06

※ Not recommended

Notes: • When the drilling depth is deeper than L/D = 5, use drill pecking every 10 to 50% of the drill diameter.

- The above cutting conditions are applied to when a water soluble cutting fluid is used. For drilling a hole smaller than ø0.3 mm, use of a starting drill is recommended.
- When setting the drill, the drill run out should be within 0.002 mm on the taper. (Especially for the drill diameter smaller than ø0.5 mm)

SOLIDDRILL DSM-CP

Centering drill for DSM drill

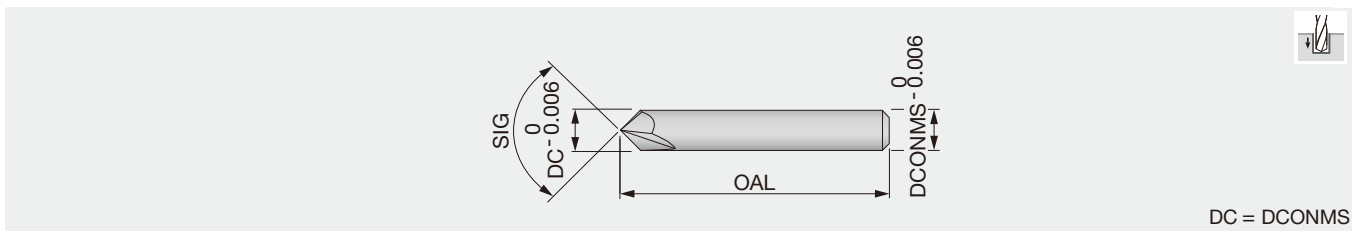

Designation	DC	YH170	DCONMS	OAL	SIG
DSM-CP90	3	●	3	38.1	90°
DSM-CP140	3	●	3	38.1	140°

● : Line up

STANDARD CUTTING CONDITIONS

ISO	Workpiece material	Hardness	Cutting speed: Vc (m/min)	Feed: f (mm/rev)	
				DSM-CP90	DSM-CP140
P	Carbon, Mild and Alloy steels	- 300 HB	30 - 80	0.01 - 0.06	0.03 - 0.08
M	Stainless steels	- 200 HB	15 - 40	0.01 - 0.03	0.02 - 0.06
K	Grey and ductile cast irons	150 - 250 HB	30 - 80	0.02 - 0.06	0.05 - 0.1
N	Aluminium alloys	-	60 - 120	0.02 - 0.1	0.05 - 0.15
H	High hardened steels	- 45 HRC	10 - 40	※	0.01 - 0.05

※ Not recommended

Notes: • For hard materials and stainless steels which have work-hardening nature, DSM-CP140 is recommended.

- Above cutting conditions are of using a water-soluble cutting fluid. When using a water-insoluble type, set the cutting speed to lower side.

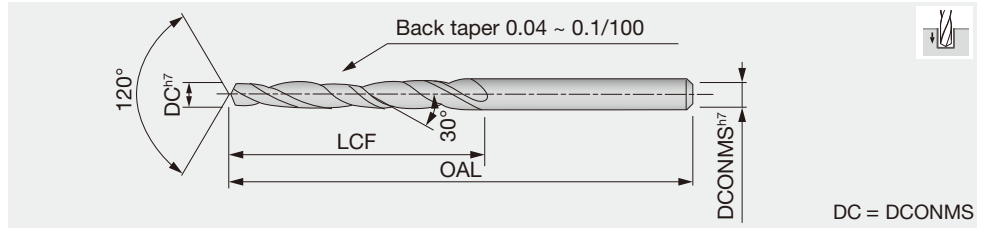

Designation	DC	UM	LCF	OAL	Designation	DC	UM	LCF	OAL
CDS-010	1	●	10	38	CDS-033	3.3	●	27	50
CDS-015	1.5	●	10	38	CDS-040	4	●	30	55
CDS-016	1.6	●	22	45	CDS-042	4.2	●	34	60
CDS-019	1.9	●	22	45	CDS-045	4.5	●	34	60
CDS-020	2	●	22	45	CDS-050	5	●	34	60
CDS-021	2.1	●	22	45	CDS-060	6	●	40	70
CDS-022	2.2	●	22	45	CDS-070	7	●	46	80
CDS-023	2.3	●	22	45	CDS-080	8	●	50	85
CDS-025	2.5	●	22	45	CDS-085	8.5	●	53	85
CDS-029	2.9	●	25	45	CDS-090	9	●	53	85
CDS-030	3	●	25	45					

● : Line up

DC	Tolerance h7 (mm)
1 < DC ≤ 3	0 ~ -0.010
3 < DC ≤ 6	0 ~ -0.012
6 < DC ≤ 9	0 ~ -0.015

CAUTIONARY NOTES

- To prevent edge chipping, hone cutting edges as follows:
 - Honing width: 0.02 ~ 0.05 mm
 - Honing angle: -20° to -30°.
 Chipping is likely to occur on edges whilst drilling hard materials, a larger honing width is recommended.
- When drilling into an inclined surface, special care should be taken to prevent drill breakage. Use of drill bushing is recommended for such case.

REGRINDING

- Carry out regrinding when corner wear reaches the margin width.
- Avoid using silicon carbide grinding wheels or hand grinding whenever possible. Use diamond grinding wheels of 200 to 400 mesh.
- Apply web thinning for the drill above ø6 mm. S-type thinning shown in figure at right is recommended. Preferable thinning width (W1) is about 1/2 to 1/3 of web thickness (W).

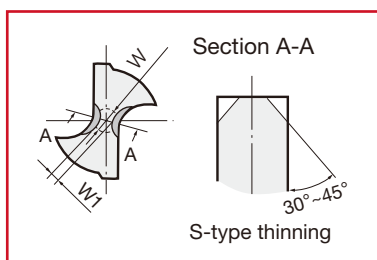

STANDARD CUTTING CONDITIONS

See more information

e-catalog



SOLIDDRILL

DSW-DE3

Solid drill/D = 3, DIN shank, without coolant hole

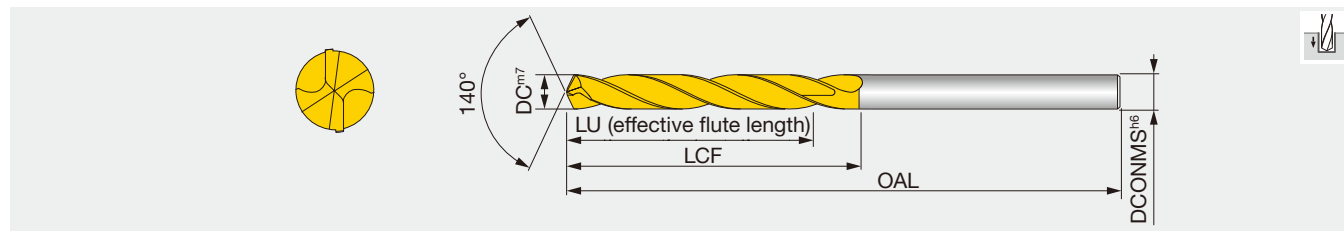

Designation	DC	AH725	DCONMS	LU	LCF	OAL	Designation	DC	AH725	DCONMS	LU	LCF	OAL
DSW030-014-06DE3	3	●	6	14	20	62	DSW076-029-08DE3	7.6	●	8	29	41	79
DSW031-014-06DE3	3.1	●	6	14	20	62	DSW077-029-08DE3	7.7	●	8	29	41	79
DSW032-014-06DE3	3.2	●	6	14	20	62	DSW078-029-08DE3	7.8	●	8	29	41	79
DSW033-014-06DE3	3.3	●	6	14	20	62	DSW079-029-08DE3	7.9	●	8	29	41	79
DSW034-014-06DE3	3.4	●	6	14	20	62	DSW080-029-08DE3	8	●	8	29	41	79
DSW035-014-06DE3	3.5	●	6	14	20	62	DSW081-035-10DE3	8.1	●	10	35	47	89
DSW036-014-06DE3	3.6	●	6	14	20	62	DSW082-035-10DE3	8.2	●	10	35	47	89
DSW037-014-06DE3	3.7	●	6	14	20	62	DSW083-035-10DE3	8.3	●	10	35	47	89
DSW038-017-06DE3	3.8	●	6	17	24	66	DSW084-035-10DE3	8.4	●	10	35	47	89
DSW039-017-06DE3	3.9	●	6	17	24	66	DSW085-035-10DE3	8.5	●	10	35	47	89
DSW040-017-06DE3	4	●	6	17	24	66	DSW086-035-10DE3	8.6	●	10	35	47	89
DSW041-017-06DE3	4.1	●	6	17	24	66	DSW087-035-10DE3	8.7	●	10	35	47	89
DSW042-017-06DE3	4.2	●	6	17	24	66	DSW088-035-10DE3	8.8	●	10	35	47	89
DSW043-017-06DE3	4.3	●	6	17	24	66	DSW089-035-10DE3	8.9	●	10	35	47	89
DSW044-017-06DE3	4.4	●	6	17	24	66	DSW090-035-10DE3	9	●	10	35	47	89
DSW045-017-06DE3	4.5	●	6	17	24	66	DSW091-035-10DE3	9.1	●	10	35	47	89
DSW046-017-06DE3	4.6	●	6	17	24	66	DSW092-035-10DE3	9.2	●	10	35	47	89
DSW047-017-06DE3	4.7	●	6	17	24	66	DSW093-035-10DE3	9.3	●	10	35	47	89
DSW048-020-06DE3	4.8	●	6	20	28	66	DSW094-035-10DE3	9.4	●	10	35	47	89
DSW049-020-06DE3	4.9	●	6	20	28	66	DSW095-035-10DE3	9.5	●	10	35	47	89
DSW050-020-06DE3	5	●	6	20	28	66	DSW096-035-10DE3	9.6	●	10	35	47	89
DSW051-020-06DE3	5.1	●	6	20	28	66	DSW097-035-10DE3	9.7	●	10	35	47	89
DSW052-020-06DE3	5.2	●	6	20	28	66	DSW098-035-10DE3	9.8	●	10	35	47	89
DSW053-020-06DE3	5.3	●	6	20	28	66	DSW099-035-10DE3	9.9	●	10	35	47	89
DSW054-020-06DE3	5.4	●	6	20	28	66	DSW100-035-10DE3	10	●	10	35	47	89
DSW055-020-06DE3	5.5	●	6	20	28	66	DSW101-040-12DE3	10.1	●	12	40	55	102
DSW056-020-06DE3	5.6	●	6	20	28	66	DSW102-040-12DE3	10.2	●	12	40	55	102
DSW057-020-06DE3	5.7	●	6	20	28	66	DSW103-040-12DE3	10.3	●	12	40	55	102
DSW058-020-06DE3	5.8	●	6	20	28	66	DSW104-040-12DE3	10.4	●	12	40	55	102
DSW059-020-06DE3	5.9	●	6	20	28	66	DSW105-040-12DE3	10.5	●	12	40	55	102
DSW060-020-06DE3	6	●	6	20	28	66	DSW106-040-12DE3	10.6	●	12	40	55	102
DSW061-024-08DE3	6.1	●	8	24	34	79	DSW107-040-12DE3	10.7	●	12	40	55	102
DSW062-024-08DE3	6.2	●	8	24	34	79	DSW108-040-12DE3	10.8	●	12	40	55	102
DSW063-024-08DE3	6.3	●	8	24	34	79	DSW109-040-12DE3	10.9	●	12	40	55	102
DSW064-024-08DE3	6.4	●	8	24	34	79	DSW110-040-12DE3	11	●	12	40	55	102
DSW065-024-08DE3	6.5	●	8	24	34	79	DSW111-040-12DE3	11.1	●	12	40	55	102
DSW066-024-08DE3	6.6	●	8	24	34	79	DSW112-040-12DE3	11.2	●	12	40	55	102
DSW067-024-08DE3	6.7	●	8	24	34	79	DSW113-040-12DE3	11.3	●	12	40	55	102
DSW068-024-08DE3	6.8	●	8	24	34	79	DSW114-040-12DE3	11.4	●	12	40	55	102
DSW069-024-08DE3	6.9	●	8	24	34	79	DSW115-040-12DE3	11.5	●	12	40	55	102
DSW070-024-08DE3	7	●	8	24	34	79	DSW116-040-12DE3	11.6	●	12	40	55	102
DSW071-029-08DE3	7.1	●	8	29	41	79	DSW117-040-12DE3	11.7	●	12	40	55	102
DSW072-029-08DE3	7.2	●	8	29	41	79	DSW118-040-12DE3	11.8	●	12	40	55	102
DSW073-029-08DE3	7.3	●	8	29	41	79	DSW119-040-12DE3	11.9	●	12	40	55	102
DSW074-029-08DE3	7.4	●	8	29	41	79	DSW120-040-12DE3	12	●	12	40	55	102
DSW075-029-08DE3	7.5	●	8	29	41	79							

● : Line up

STANDARD CUTTING CONDITIONS

See more information

e-catalog



DSW-DE5

Solid drill, L/D = 5, DIN shank, without coolant hole

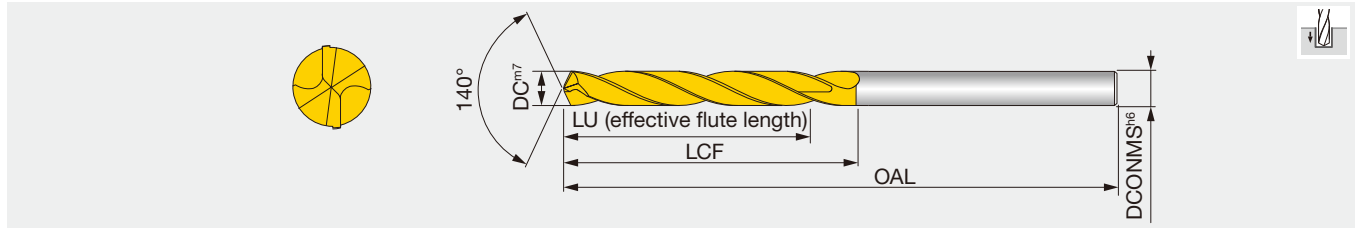

Designation	DC	AH725	DCONMS	LU	LCF	OAL	Designation	DC	AH725	DCONMS	LU	LCF	OAL
DSW030-023-06DE5	3	●	6	23	28	66	DSW076-043-08DE5	7.6	●	8	43	53	91
DSW031-023-06DE5	3.1	●	6	23	28	66	DSW077-043-08DE5	7.7	●	8	43	53	91
DSW032-023-06DE5	3.2	●	6	23	28	66	DSW078-043-08DE5	7.8	●	8	43	53	91
DSW033-023-06DE5	3.3	●	6	23	28	66	DSW079-043-08DE5	7.9	●	8	43	53	91
DSW034-023-06DE5	3.4	●	6	23	28	66	DSW080-043-08DE5	8	●	8	43	53	91
DSW035-023-06DE5	3.5	●	6	23	28	66	DSW081-049-10DE5	8.1	●	10	49	61	103
DSW036-023-06DE5	3.6	●	6	23	28	66	DSW082-049-10DE5	8.2	●	10	49	61	103
DSW037-023-06DE5	3.7	●	6	23	28	66	DSW083-049-10DE5	8.3	●	10	49	61	103
DSW038-029-06DE5	3.8	●	6	29	36	74	DSW084-049-10DE5	8.4	●	10	49	61	103
DSW039-029-06DE5	3.9	●	6	29	36	74	DSW085-049-10DE5	8.5	●	10	49	61	103
DSW040-029-06DE5	4	●	6	29	36	74	DSW086-049-10DE5	8.6	●	10	49	61	103
DSW041-029-06DE5	4.1	●	6	29	36	74	DSW087-049-10DE5	8.7	●	10	49	61	103
DSW042-029-06DE5	4.2	●	6	29	36	74	DSW088-049-10DE5	8.8	●	10	49	61	103
DSW043-029-06DE5	4.3	●	6	29	36	74	DSW089-049-10DE5	8.9	●	10	49	61	103
DSW044-029-06DE5	4.4	●	6	29	36	74	DSW090-049-10DE5	9	●	10	49	61	103
DSW045-029-06DE5	4.5	●	6	29	36	74	DSW091-049-10DE5	9.1	●	10	49	61	103
DSW046-029-06DE5	4.6	●	6	29	36	74	DSW092-049-10DE5	9.2	●	10	49	61	103
DSW047-029-06DE5	4.7	●	6	29	36	74	DSW093-049-10DE5	9.3	●	10	49	61	103
DSW048-035-06DE5	4.8	●	6	35	44	82	DSW094-049-10DE5	9.4	●	10	49	61	103
DSW049-035-06DE5	4.9	●	6	35	44	82	DSW095-049-10DE5	9.5	●	10	49	61	103
DSW050-035-06DE5	5	●	6	35	44	82	DSW096-049-10DE5	9.6	●	10	49	61	103
DSW051-035-06DE5	5.1	●	6	35	44	82	DSW097-049-10DE5	9.7	●	10	49	61	103
DSW052-035-06DE5	5.2	●	6	35	44	82	DSW098-049-10DE5	9.8	●	10	49	61	103
DSW053-035-06DE5	5.3	●	6	35	44	82	DSW099-049-10DE5	9.9	●	10	49	61	103
DSW054-035-06DE5	5.4	●	6	35	44	82	DSW100-049-10DE5	10	●	10	49	61	103
DSW055-035-06DE5	5.5	●	6	35	44	82	DSW101-056-12DE5	10.1	●	12	56	71	118
DSW056-035-06DE5	5.6	●	6	35	44	82	DSW102-056-12DE5	10.2	●	12	56	71	118
DSW057-035-06DE5	5.7	●	6	35	44	82	DSW103-056-12DE5	10.3	●	12	56	71	118
DSW058-035-06DE5	5.8	●	6	35	44	82	DSW104-056-12DE5	10.4	●	12	56	71	118
DSW059-035-06DE5	5.9	●	6	35	44	82	DSW105-056-12DE5	10.5	●	12	56	71	118
DSW060-035-06DE5	6	●	6	35	44	82	DSW106-056-12DE5	10.6	●	12	56	71	118
DSW061-043-08DE5	6.1	●	8	43	53	91	DSW107-056-12DE5	10.7	●	12	56	71	118
DSW062-043-08DE5	6.2	●	8	43	53	91	DSW108-056-12DE5	10.8	●	12	56	71	118
DSW063-043-08DE5	6.3	●	8	43	53	91	DSW109-056-12DE5	10.9	●	12	56	71	118
DSW064-043-08DE5	6.4	●	8	43	53	91	DSW110-056-12DE5	11	●	12	56	71	118
DSW065-043-08DE5	6.5	●	8	43	53	91	DSW111-056-12DE5	11.1	●	12	56	71	118
DSW066-043-08DE5	6.6	●	8	43	53	91	DSW112-056-12DE5	11.2	●	12	56	71	118
DSW067-043-08DE5	6.7	●	8	43	53	91	DSW113-056-12DE5	11.3	●	12	56	71	118
DSW068-043-08DE5	6.8	●	8	43	53	91	DSW114-056-12DE5	11.4	●	12	56	71	118
DSW069-043-08DE5	6.9	●	8	43	53	91	DSW115-056-12DE5	11.5	●	12	56	71	118
DSW070-043-08DE5	7	●	8	43	53	91	DSW116-056-12DE5	11.6	●	12	56	71	118
DSW071-043-08DE5	7.1	●	8	43	53	91	DSW117-056-12DE5	11.7	●	12	56	71	118
DSW072-043-08DE5	7.2	●	8	43	53	91	DSW118-056-12DE5	11.8	●	12	56	71	118
DSW073-043-08DE5	7.3	●	8	43	53	91	DSW119-056-12DE5	11.9	●	12	56	71	118
DSW074-043-08DE5	7.4	●	8	43	53	91	DSW120-056-12DE5	12	●	12	56	71	118
DSW075-043-08DE5	7.5	●	8	43	53	91							

● : Line up

STANDARD CUTTING CONDITIONS

See more information

e-catalog



SOLIDDRILL

DSW-DI5

Solid drill, L/D = 5, DIN shank, with coolant hole

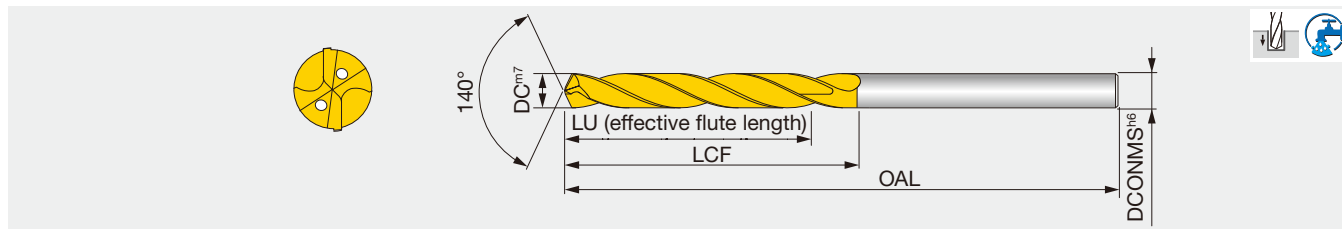

Designation	DC	AH725	DCONMS	LU	LCF	OAL	Designation	DC	AH725	DCONMS	LU	LCF	OAL
DSW030-023-06DI5	3	●	6	23	28	66	DSW076-043-08DI5	7.6	●	8	43	53	91
DSW031-023-06DI5	3.1	●	6	23	28	66	DSW077-043-08DI5	7.7	●	8	43	53	91
DSW032-023-06DI5	3.2	●	6	23	28	66	DSW078-043-08DI5	7.8	●	8	43	53	91
DSW033-023-06DI5	3.3	●	6	23	28	66	DSW079-043-08DI5	7.9	●	8	43	53	91
DSW034-023-06DI5	3.4	●	6	23	28	66	DSW080-043-08DI5	8	●	8	43	53	91
DSW035-023-06DI5	3.5	●	6	23	28	66	DSW081-049-10DI5	8.1	●	10	49	61	103
DSW036-023-06DI5	3.6	●	6	23	28	66	DSW082-049-10DI5	8.2	●	10	49	61	103
DSW037-023-06DI5	3.7	●	6	23	28	66	DSW083-049-10DI5	8.3	●	10	49	61	103
DSW038-029-06DI5	3.8	●	6	29	36	74	DSW084-049-10DI5	8.4	●	10	49	61	103
DSW039-029-06DI5	3.9	●	6	29	36	74	DSW085-049-10DI5	8.5	●	10	49	61	103
DSW040-029-06DI5	4	●	6	29	36	74	DSW086-049-10DI5	8.6	●	10	49	61	103
DSW041-029-06DI5	4.1	●	6	29	36	74	DSW087-049-10DI5	8.7	●	10	49	61	103
DSW042-029-06DI5	4.2	●	6	29	36	74	DSW088-049-10DI5	8.8	●	10	49	61	103
DSW043-029-06DI5	4.3	●	6	29	36	74	DSW089-049-10DI5	8.9	●	10	49	61	103
DSW044-029-06DI5	4.4	●	6	29	36	74	DSW090-049-10DI5	9	●	10	49	61	103
DSW045-029-06DI5	4.5	●	6	29	36	74	DSW091-049-10DI5	9.1	●	10	49	61	103
DSW046-029-06DI5	4.6	●	6	29	36	74	DSW092-049-10DI5	9.2	●	10	49	61	103
DSW047-029-06DI5	4.7	●	6	29	36	74	DSW093-049-10DI5	9.3	●	10	49	61	103
DSW048-035-06DI5	4.8	●	6	35	44	82	DSW094-049-10DI5	9.4	●	10	49	61	103
DSW049-035-06DI5	4.9	●	6	35	44	82	DSW095-049-10DI5	9.5	●	10	49	61	103
DSW050-035-06DI5	5	●	6	35	44	82	DSW096-049-10DI5	9.6	●	10	49	61	103
DSW051-035-06DI5	5.1	●	6	35	44	82	DSW097-049-10DI5	9.7	●	10	49	61	103
DSW052-035-06DI5	5.2	●	6	35	44	82	DSW098-049-10DI5	9.8	●	10	49	61	103
DSW053-035-06DI5	5.3	●	6	35	44	82	DSW099-049-10DI5	9.9	●	10	49	61	103
DSW054-035-06DI5	5.4	●	6	35	44	82	DSW100-049-10DI5	10	●	10	49	61	103
DSW055-035-06DI5	5.5	●	6	35	44	82	DSW101-056-12DI5	10.1	●	12	56	71	118
DSW056-035-06DI5	5.6	●	6	35	44	82	DSW102-056-12DI5	10.2	●	12	56	71	118
DSW057-035-06DI5	5.7	●	6	35	44	82	DSW103-056-12DI5	10.3	●	12	56	71	118
DSW058-035-06DI5	5.8	●	6	35	44	82	DSW104-056-12DI5	10.4	●	12	56	71	118
DSW059-035-06DI5	5.9	●	6	35	44	82	DSW105-056-12DI5	10.5	●	12	56	71	118
DSW060-035-06DI5	6	●	6	35	44	82	DSW106-056-12DI5	10.6	●	12	56	71	118
DSW061-043-08DI5	6.1	●	8	43	53	91	DSW107-056-12DI5	10.7	●	12	56	71	118
DSW062-043-08DI5	6.2	●	8	43	53	91	DSW108-056-12DI5	10.8	●	12	56	71	118
DSW063-043-08DI5	6.3	●	8	43	53	91	DSW109-056-12DI5	10.9	●	12	56	71	118
DSW064-043-08DI5	6.4	●	8	43	53	91	DSW110-056-12DI5	11	●	12	56	71	118
DSW065-043-08DI5	6.5	●	8	43	53	91	DSW111-056-12DI5	11.1	●	12	56	71	118
DSW066-043-08DI5	6.6	●	8	43	53	91	DSW112-056-12DI5	11.2	●	12	56	71	118
DSW067-043-08DI5	6.7	●	8	43	53	91	DSW113-056-12DI5	11.3	●	12	56	71	118
DSW068-043-08DI5	6.8	●	8	43	53	91	DSW114-056-12DI5	11.4	●	12	56	71	118
DSW069-043-08DI5	6.9	●	8	43	53	91	DSW115-056-12DI5	11.5	●	12	56	71	118
DSW070-043-08DI5	7	●	8	43	53	91	DSW116-056-12DI5	11.6	●	12	56	71	118
DSW071-043-08DI5	7.1	●	8	43	53	91	DSW117-056-12DI5	11.7	●	12	56	71	118
DSW072-043-08DI5	7.2	●	8	43	53	91	DSW118-056-12DI5	11.8	●	12	56	71	118
DSW073-043-08DI5	7.3	●	8	43	53	91	DSW119-056-12DI5	11.9	●	12	56	71	118
DSW074-043-08DI5	7.4	●	8	43	53	91	DSW120-056-12DI5	12	●	12	56	71	118
DSW075-043-08DI5	7.5	●	8	43	53	91							

● : Line up

STANDARD CUTTING CONDITIONS

See more information

e-catalog



DSW-DI8

Solid drill, L/D = 8, DIN shank, with coolant hole

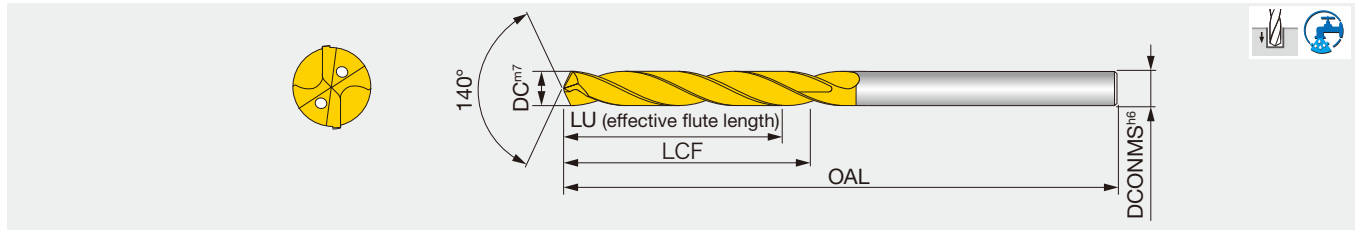

Designation	DC	AH725	DCONMS	LU	LCF	OAL	Designation	DC	AH725	DCONMS	LU	LCF	OAL
DSW030-029-06DI8	3	●	6	29	34	72	DSW066-064-08DI8	6.6	●	8	64	76	114
DSW031-029-06DI8	3.1	●	6	29	34	72	DSW067-064-08DI8	6.7	●	8	64	76	114
DSW032-029-06DI8	3.2	●	6	29	34	72	DSW068-064-08DI8	6.8	●	8	64	76	114
DSW033-029-06DI8	3.3	●	6	29	34	72	DSW069-064-08DI8	6.9	●	8	64	76	114
DSW034-029-06DI8	3.4	●	6	29	34	72	DSW070-064-08DI8	7	●	8	64	76	114
DSW035-029-06DI8	3.5	●	6	29	34	72	DSW071-064-08DI8	7.1	●	8	64	76	114
DSW036-029-06DI8	3.6	●	6	29	34	72	DSW072-064-08DI8	7.2	●	8	64	76	114
DSW037-029-06DI8	3.7	●	6	29	34	72	DSW073-064-08DI8	7.3	●	8	64	76	114
DSW038-036-06DI8	3.8	●	6	36	43	81	DSW074-064-08DI8	7.4	●	8	64	76	114
DSW039-036-06DI8	3.9	●	6	36	43	81	DSW075-064-08DI8	7.5	●	8	64	76	114
DSW040-036-06DI8	4	●	6	36	43	81	DSW076-064-08DI8	7.6	●	8	64	76	114
DSW041-036-06DI8	4.1	●	6	36	43	81	DSW077-064-08DI8	7.7	●	8	64	76	114
DSW042-036-06DI8	4.2	●	6	36	43	81	DSW078-064-08DI8	7.8	●	8	64	76	114
DSW043-036-06DI8	4.3	●	6	36	43	81	DSW079-064-08DI8	7.9	●	8	64	76	114
DSW044-036-06DI8	4.4	●	6	36	43	81	DSW080-064-08DI8	8	●	8	64	76	114
DSW045-036-06DI8	4.5	●	6	36	43	81	DSW081-080-10DI8	8.1	●	10	80	95	142
DSW046-036-06DI8	4.6	●	6	36	43	81	DSW082-080-10DI8	8.2	●	10	80	95	142
DSW047-036-06DI8	4.7	●	6	36	43	81	DSW083-080-10DI8	8.3	●	10	80	95	142
DSW048-048-06DI8	4.8	●	6	48	57	95	DSW084-080-10DI8	8.4	●	10	80	95	142
DSW049-048-06DI8	4.9	●	6	48	57	95	DSW085-080-10DI8	8.5	●	10	80	95	142
DSW050-048-06DI8	5	●	6	48	57	95	DSW086-080-10DI8	8.6	●	10	80	95	142
DSW051-048-06DI8	5.1	●	6	48	57	95	DSW087-080-10DI8	8.7	●	10	80	95	142
DSW052-048-06DI8	5.2	●	6	48	57	95	DSW088-080-10DI8	8.8	●	10	80	95	142
DSW053-048-06DI8	5.3	●	6	48	57	95	DSW089-080-10DI8	8.9	●	10	80	95	142
DSW054-048-06DI8	5.4	●	6	48	57	95	DSW090-080-10DI8	9	●	10	80	95	142
DSW055-048-06DI8	5.5	●	6	48	57	95	DSW091-080-10DI8	9.1	●	10	80	95	142
DSW056-048-06DI8	5.6	●	6	48	57	95	DSW092-080-10DI8	9.2	●	10	80	95	142
DSW057-048-06DI8	5.7	●	6	48	57	95	DSW093-080-10DI8	9.3	●	10	80	95	142
DSW058-048-06DI8	5.8	●	6	48	57	95	DSW094-080-10DI8	9.4	●	10	80	95	142
DSW059-048-06DI8	5.9	●	6	48	57	95	DSW095-080-10DI8	9.5	●	10	80	95	142
DSW060-048-06DI8	6	●	6	48	57	95	DSW096-080-10DI8	9.6	●	10	80	95	142
DSW061-064-08DI8	6.1	●	8	64	76	114	DSW097-080-10DI8	9.7	●	10	80	95	142
DSW062-064-08DI8	6.2	●	8	64	76	114	DSW098-080-10DI8	9.8	●	10	80	95	142
DSW063-064-08DI8	6.3	●	8	64	76	114	DSW099-080-10DI8	9.9	●	10	80	95	142
DSW064-064-08DI8	6.4	●	8	64	76	114	DSW100-080-10DI8	10	●	10	80	95	142
DSW065-064-08DI8	6.5	●	8	64	76	114							

● : Line up

STANDARD CUTTING CONDITIONS

See more information

e-catalog



Grade
Insert
Ext. Toolholder
Int. Toolholder
Threading
Grooving
Miniature tool
Milling cutter
Endmill
Drilling tool
Tooling System
User's Guide
Index

A
B
C
D
E
F
G
H
I
J
K
L
M

Recommended coolant pressure and volume for internal coolant supply:

The following graph is a reference guide for pressure and volume. Values should be adjusted according to work material and actual chip evacuation.

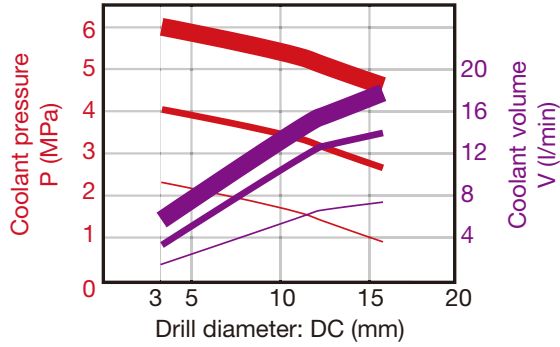

- █ : Ideal pressure
- █ : Enough pressure
- █ : Minimum pressure
- █ : Ideal volume
- █ : Enough volume
- █ : Minimum volume

Reference for required spindle power:

The required spindle power may vary depending on the type of work material or hardness. A spindle with sufficient power should be used when referring to the below graph.

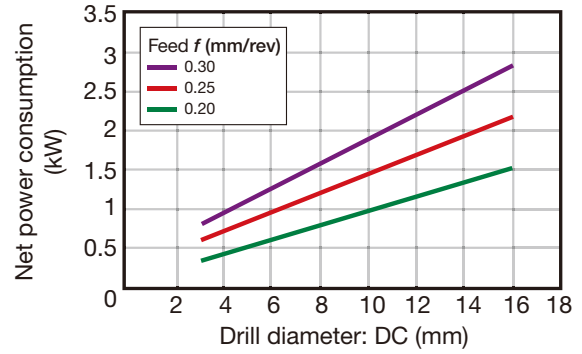

Work material : Alloy steel (SNCM439)
 Cutting speed : $V_c = 100$ m/min

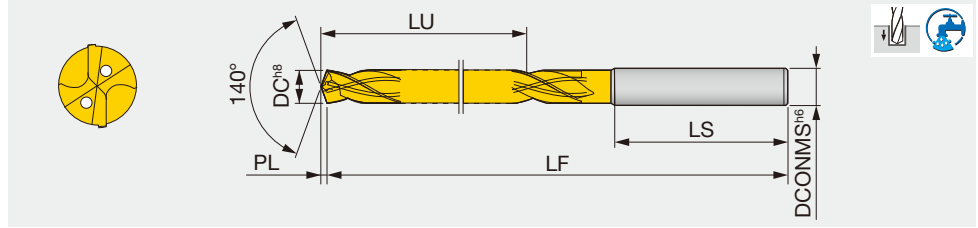

Designation	DC	AH180	DCONMS	LU	LS	LF	PL	Designation	DC	AH180	DCONMS	LU	LS	LF	PL
DSX0300F03	3	●	3	9.6	48	68	0.55	DSX0740F03	7.4	●	8	23.6	54	92	1.35
DSX0310F03	3.1	●	4	9.9	48	71	0.56	DSX0750F03	7.5	●	8	23.9	54	92	1.36
DSX0320F03	3.2	●	4	10.2	48	71	0.58	DSX0760F03	7.6	●	8	24.2	54	94	1.38
DSX0330F03	3.3	●	4	10.5	48	71	0.6	DSX0770F03	7.7	●	8	24.5	54	94	1.4
DSX0340F03	3.4	●	4	10.8	48	71	0.62	DSX0780F03	7.8	●	8	24.8	54	94	1.42
DSX0350F03	3.5	●	4	11.1	48	71	0.64	DSX0790F03	7.9	●	8	25.1	54	94	1.44
DSX0360F03	3.6	●	4	11.5	48	73	0.66	DSX0800F03	8	●	8	25.5	54	94	1.46
DSX0370F03	3.7	●	4	11.8	48	73	0.67	DSX0810F03	8.1	●	9	25.8	55	100	1.47
DSX0380F03	3.8	●	4	12.1	48	73	0.69	DSX0820F03	8.2	●	9	26.1	55	100	1.49
DSX0390F03	3.9	●	4	12.4	48	73	0.71	DSX0830F03	8.3	●	9	26.4	55	100	1.51
DSX0400F03	4	●	4	12.7	48	73	0.73	DSX0840F03	8.4	●	9	26.7	55	100	1.53
DSX0410F03	4.1	●	5	13.1	50	78	0.75	DSX0850F03	8.5	●	9	27.1	55	100	1.55
DSX0420F03	4.2	●	5	13.4	50	78	0.76	DSX0860F03	8.6	●	9	27.4	55	100	1.57
DSX0430F03	4.3	●	5	13.7	50	78	0.78	DSX0870F03	8.7	●	9	27.7	55	100	1.58
DSX0440F03	4.4	●	5	14	50	78	0.8	DSX0880F03	8.8	●	9	28	55	100	1.6
DSX0450F03	4.5	●	5	14.3	50	78	0.82	DSX0890F03	8.9	●	9	28.3	55	100	1.62
DSX0460F03	4.6	●	5	14.6	50	80	0.84	DSX0900F03	9	●	9	28.6	55	100	1.64
DSX0470F03	4.7	●	5	15	50	80	0.86	DSX0910F03	9.1	●	10	29	56	106	1.66
DSX0480F03	4.8	●	5	15.3	50	80	0.87	DSX0920F03	9.2	●	10	29.3	56	106	1.67
DSX0490F03	4.9	●	5	15.6	50	80	0.89	DSX0930F03	9.3	●	10	29.6	56	106	1.69
DSX0500F03	5	●	5	15.9	50	80	0.91	DSX0940F03	9.4	●	10	29.9	56	106	1.71
DSX0510F03	5.1	●	6	16.2	52	82	0.93	DSX0950F03	9.5	●	10	30.2	56	106	1.73
DSX0520F03	5.2	●	6	16.6	52	82	0.95	DSX0960F03	9.6	●	10	30.6	56	106	1.75
DSX0530F03	5.3	●	6	16.9	52	82	0.96	DSX0970F03	9.7	●	10	30.9	56	106	1.77
DSX0540F03	5.4	●	6	17.2	52	82	0.98	DSX0980F03	9.8	●	10	31.2	56	106	1.78
DSX0550F03	5.5	●	6	17.5	52	82	1	DSX0990F03	9.9	●	10	31.5	56	106	1.8
DSX0560F03	5.6	●	6	17.8	52	82	1.02	DSX1000F03	10	●	10	31.8	56	106	1.82
DSX0570F03	5.7	●	6	18.1	52	82	1.04	DSX1030F03	10.3	●	11	32.8	61	116	1.87
DSX0580F03	5.8	●	6	18.5	52	82	1.06	DSX1050F03	10.5	●	11	33.4	61	116	1.91
DSX0590F03	5.9	●	6	18.8	52	82	1.07	DSX1080F03	10.8	●	11	34.4	61	116	1.97
DSX0600F03	6	●	6	19.1	52	82	1.09	DSX1100F03	11	●	11	35	61	116	2
DSX0610F03	6.1	●	7	19.4	53	86	1.11	DSX1180F03	11.8	●	12	37.5	62	122	2.15
DSX0620F03	6.2	●	7	19.7	53	86	1.13	DSX1210F03	12.1	●	13	38.5	63	128	2.2
DSX0630F03	6.3	●	7	20.1	53	86	1.15	DSX1250F03	12.5	●	13	39.8	63	128	2.27
DSX0640F03	6.4	●	7	20.4	53	86	1.16	DSX1300F03	13	●	13	41.4	63	128	2.37
DSX0650F03	6.5	●	7	20.7	53	86	1.18	DSX1370F03	13.7	●	14	43.6	64	134	2.49
DSX0660F03	6.6	●	7	21	53	88	1.2	DSX1400F03	14	●	14	44.5	64	134	2.55
DSX0670F03	6.7	●	7	21.3	53	88	1.22	DSX1410F03	14.1	●	15	44.9	65	140	2.57
DSX0680F03	6.8	●	7	21.6	53	88	1.24	DSX1550F03	15.5	●	16	49.3	66	146	2.82
DSX0690F03	6.9	●	7	22	53	88	1.26	DSX1600F03	16	●	16	50.9	66	146	2.91
DSX0700F03	7	●	7	22.3	53	88	1.27	DSX1650F03	16.5	●	17	52.5	67	152	3
DSX0710F03	7.1	●	8	22.6	54	92	1.29	DSX1750F03	17.5	●	18	55.7	68	158	3.18
DSX0720F03	7.2	●	8	22.9	54	92	1.31	DSX2000F03	20	●	20	63.6	70	170	3.64
DSX0730F03	7.3	●	8	23.2	54	92	1.33								

● : Line up

STANDARD CUTTING CONDITIONS

See more information

e-catalog



SOLIDDRILL

DSX-F05

Solid drill, L/D = 5, with coolant hole

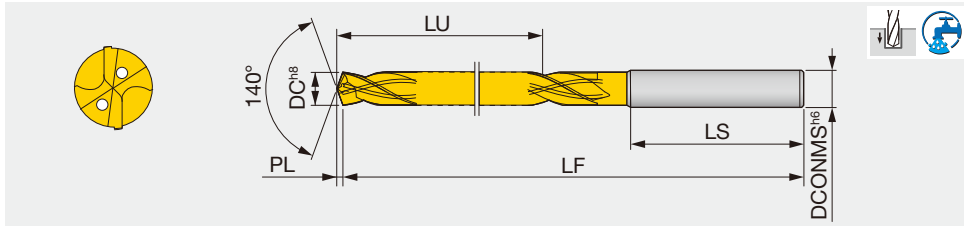

Designation	DC	AH180	DCONMS	LU	LS	LF	PL	Designation	DC	AH180	DCONMS	LU	LS	LF	PL
DSX0300F05	3	●	3	15.6	48	77	0.55	DSX0730F05	7.3	●	8	37.8	54	114	1.33
DSX0310F05	3.1	●	4	16.1	48	81	0.56	DSX0740F05	7.4	●	8	38.4	54	114	1.35
DSX0320F05	3.2	●	4	16.6	48	81	0.58	DSX0750F05	7.5	●	8	38.9	54	114	1.36
DSX0330F05	3.3	●	4	17.1	48	81	0.6	DSX0760F05	7.6	●	8	39.4	54	118	1.38
DSX0340F05	3.4	●	4	17.6	48	81	0.62	DSX0770F05	7.7	●	8	39.9	54	118	1.4
DSX0350F05	3.5	●	4	18.1	48	81	0.64	DSX0780F05	7.8	●	8	40.4	54	118	1.42
DSX0360F05	3.6	●	4	18.7	48	85	0.66	DSX0790F05	7.9	●	8	40.9	54	118	1.44
DSX0370F05	3.7	●	4	19.2	48	85	0.67	DSX0800F05	8	●	8	41.5	54	118	1.46
DSX0380F05	3.8	●	4	19.7	48	85	0.69	DSX0810F05	8.1	●	9	42	55	127	1.47
DSX0390F05	3.9	●	4	20.2	48	85	0.71	DSX0820F05	8.2	●	9	42.5	55	127	1.49
DSX0400F05	4	●	4	20.7	48	85	0.73	DSX0830F05	8.3	●	9	43	55	127	1.51
DSX0410F05	4.1	●	5	21.3	50	91	0.75	DSX0840F05	8.4	●	9	43.5	55	127	1.53
DSX0420F05	4.2	●	5	21.8	50	91	0.76	DSX0850F05	8.5	●	9	44	55	127	1.55
DSX0430F05	4.3	●	5	22.3	50	91	0.78	DSX0860F05	8.6	●	9	44.6	55	127	1.57
DSX0440F05	4.4	●	5	22.8	50	91	0.8	DSX0870F05	8.7	●	9	45.1	55	127	1.58
DSX0450F05	4.5	●	5	23.3	50	91	0.82	DSX0880F05	8.8	●	9	45.6	55	127	1.6
DSX0460F05	4.6	●	5	23.8	50	94	0.84	DSX0890F05	8.9	●	9	46.1	55	127	1.62
DSX0470F05	4.7	●	5	24.4	50	94	0.86	DSX0900F05	9	●	9	46.6	55	127	1.64
DSX0480F05	4.8	●	5	24.9	50	94	0.87	DSX0910F05	9.1	●	10	47.2	56	136	1.66
DSX0490F05	4.9	●	5	25.4	50	94	0.89	DSX0920F05	9.2	●	10	47.7	56	136	1.67
DSX0500F05	5	●	5	25.9	50	94	0.91	DSX0930F05	9.3	●	10	48.2	56	136	1.69
DSX0510F05	5.1	●	6	26.4	52	96	0.93	DSX0940F05	9.4	●	10	48.7	56	136	1.71
DSX0520F05	5.2	●	6	26.9	52	96	0.95	DSX0950F05	9.5	●	10	49.2	56	136	1.73
DSX0530F05	5.3	●	6	27.5	52	96	0.96	DSX0960F05	9.6	●	10	49.8	56	136	1.75
DSX0540F05	5.4	●	6	28	52	96	0.98	DSX0970F05	9.7	●	10	50.3	56	136	1.77
DSX0550F05	5.5	●	6	28.5	52	96	1	DSX0980F05	9.8	●	10	50.8	56	136	1.78
DSX0560F05	5.6	●	6	29	52	100	1.02	DSX0990F05	9.9	●	10	51.3	56	136	1.8
DSX0570F05	5.7	●	6	29.5	52	100	1.04	DSX1000F05	10	●	10	51.8	56	136	1.82
DSX0580F05	5.8	●	6	30.1	52	100	1.06	DSX1020F05	10.2	●	11	52.9	61	149	1.86
DSX0590F05	5.9	●	6	30.6	52	100	1.07	DSX1030F05	10.3	●	11	53.4	61	149	1.87
DSX0600F05	6	●	6	31.1	52	100	1.09	DSX1050F05	10.5	●	11	54.4	61	149	1.91
DSX0610F05	6.1	●	7	31.6	53	105	1.11	DSX1100F05	11	●	11	57	61	149	2
DSX0620F05	6.2	●	7	32.1	53	105	1.13	DSX1110F05	11.1	●	12	57.5	62	158	2.02
DSX0630F05	6.3	●	7	32.6	53	105	1.15	DSX1150F05	11.5	●	12	59.6	62	158	2.09
DSX0640F05	6.4	●	7	33.2	53	105	1.16	DSX1180F05	11.8	●	12	61.1	62	158	2.15
DSX0650F05	6.5	●	7	33.7	53	105	1.18	DSX1220F05	12.2	●	13	63.2	63	167	2.22
DSX0660F05	6.6	●	7	34.2	53	109	1.2	DSX1300F05	13	●	13	67.4	63	167	2.37
DSX0670F05	6.7	●	7	34.7	53	109	1.22	DSX1350F05	13.5	●	14	70	64	176	2.46
DSX0680F05	6.8	●	7	35.2	53	109	1.24	DSX1400F05	14	●	14	72.5	64	176	2.55
DSX0690F05	6.9	●	7	35.8	53	109	1.26	DSX1410F05	14.1	●	15	73.1	65	185	2.57
DSX0700F05	7	●	7	36.3	53	109	1.27	DSX1600F05	16	●	16	82.9	66	194	2.91
DSX0710F05	7.1	●	8	36.8	54	114	1.29	DSX1750F05	17.5	●	18	90.7	68	212	3.18
DSX0720F05	7.2	●	8	37.3	54	114	1.31	DSX1800F05	18	●	18	93.3	68	212	3.28

● : Line up

STANDARD CUTTING CONDITIONS

See more information

e-catalog



DSX-F08

Solid drill, L/D = 8, with coolant hole

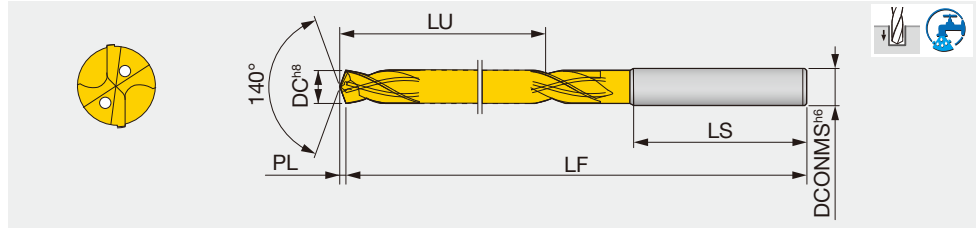

Designation	DC	AH180	DCONMS	LU	LS	LF	PL	Designation	DC	AH180	DCONMS	LU	LS	LF	PL
DSX0300F08	3	●	3	33.6	48	86	0.55	DSX0750F08	7.5	●	8	84.4	54	137	1.36
DSX0350F08	3.5	●	4	39.6	48	92	0.64	DSX0800F08	8	●	8	89.5	54	142	1.46
DSX0400F08	4	●	4	44.7	48	97	0.73	DSX0830F08	8.3	●	9	95.5	55	154	1.51
DSX0450F08	4.5	●	5	50.8	50	105	0.82	DSX0850F08	8.5	●	9	95.6	55	154	1.55
DSX0500F08	5	●	5	55.9	50	110	0.91	DSX0900F08	9	●	9	100.6	55	154	1.64
DSX0510F08	5.1	●	6	61.9	52	113	0.93	DSX0950F08	9.5	●	10	106.7	56	166	1.73
DSX0550F08	5.5	●	6	62	52	113	1	DSX1000F08	10	●	10	111.8	56	166	1.82
DSX0600F08	6	●	6	67.1	52	118	1.09	DSX1100F08	11	●	11	90	61	182	2
DSX0650F08	6.5	●	7	73.2	53	125	1.18	DSX1300F08	13	●	13	106.4	63	206	2.37
DSX0700F08	7	●	7	78.3	53	130	1.27								

● : Line up

STANDARD CUTTING CONDITIONS

See more information

e-catalog



DSE-F02

Solid drill, L/D = 2, without coolant hole

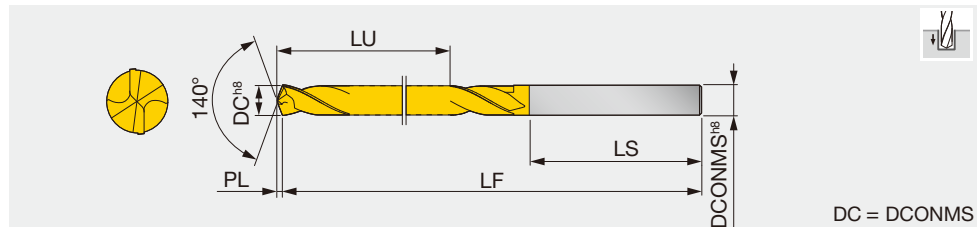

Designation	DC	AH180	DCONMS	LU	LS	LF	PL	Designation	DC	AH180	DCONMS	LU	LS	LF	PL
DSE0300F02	3	●	3	16.6	30	46	0.55	DSE0640F02	6.4	●	6.4	32.2	39	70	1.16
DSE0320F02	3.2	●	3.2	18.6	31	49	0.58	DSE0650F02	6.5	●	6.5	32.2	39	70	1.18
DSE0340F02	3.4	●	3.4	20.6	32	52	0.62	DSE0680F02	6.8	●	6.8	35.2	40	74	1.24
DSE0350F02	3.5	●	3.5	20.6	32	52	0.64	DSE0700F02	7	●	7	35.3	40	74	1.27
DSE0400F02	4	●	4	22.7	33	55	0.73	DSE0750F02	7.5	●	7.5	35.4	40	74	1.36
DSE0430F02	4.3	●	4.3	24.8	34	58	0.78	DSE0800F02	8	●	8	38.5	42	79	1.46
DSE0450F02	4.5	●	4.5	24.8	34	58	0.82	DSE0850F02	8.5	●	8.5	38.6	42	79	1.55
DSE0500F02	5	●	5	26.9	36	62	0.91	DSE0900F02	9	●	9	41.6	44	84	1.64
DSE0510F02	5.1	●	5.1	26.9	36	62	0.93	DSE0950F02	9.5	●	9.5	41.7	44	84	1.73
DSE0550F02	5.5	●	5.5	29	38	66	1	DSE1000F02	10	●	10	44.8	46	89	1.82
DSE0560F02	5.6	●	5.6	29	38	66	1.02	DSE1500F02	15	●	15	58.7	55	111	2.73
DSE0600F02	6	●	6	29.1	38	66	1.09								

● : Line up

STANDARD CUTTING CONDITIONS

See more information

e-catalog



SOLIDDRILL

DSE-F03

Solid drill, L/D = 3, without coolant hole

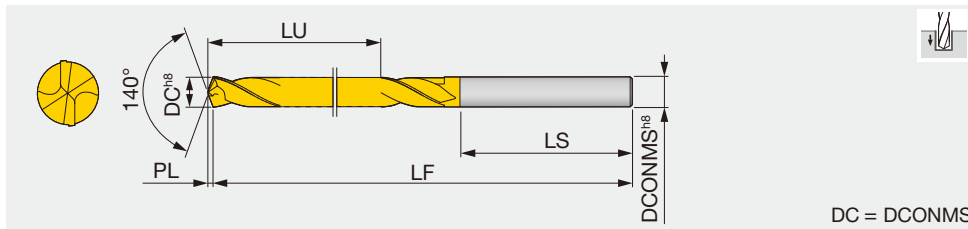

Designation	DC	AH180	DCONMS	LU	LS	LF	PL	Designation	DC	AH180	DCONMS	LU	LS	LF	PL
DSE0300F03	3	●	3	21.6	39	60	0.55	DSE0700F03	7	●	7	44.3	40	83	1.27
DSE0320F03	3.2	●	3.2	24.6	36	60	0.58	DSE0740F03	7.4	●	7.4	46.4	42	87	1.35
DSE0340F03	3.4	●	3.4	24.6	36	60	0.62	DSE0750F03	7.5	●	7.5	46.4	42	87	1.36
DSE0350F03	3.5	●	3.5	24.6	36	60	0.64	DSE0800F03	8	●	8	49.5	42	90	1.46
DSE0400F03	4	●	4	27.7	33	60	0.73	DSE0850F03	8.5	●	8.5	54.6	43	96	1.55
DSE0430F03	4.3	●	4.3	29.8	34	63	0.78	DSE0860F03	8.6	●	8.6	56.6	43	98	1.57
DSE0450F03	4.5	●	4.5	29.8	34	63	0.82	DSE0900F03	9	●	9	56.6	43	98	1.64
DSE0500F03	5	●	5	32.9	36	68	0.91	DSE0950F03	9.5	●	9.5	59.7	44	102	1.73
DSE0510F03	5.1	●	5.1	34.9	38	72	0.93	DSE1000F03	10	●	10	61.8	45	105	1.82
DSE0550F03	5.5	●	5.5	35	38	72	1	DSE1030F03	10.3	●	10.3	67.9	46	112	1.87
DSE0600F03	6	●	6	42.1	40	81	1.09	DSE1050F03	10.5	●	10.5	67.9	46	112	1.91
DSE0650F03	6.5	●	6.5	42.2	40	81	1.18	DSE1100F03	11	●	11	70	46	114	2
DSE0680F03	6.8	●	6.8	44.2	40	83	1.24	DSE1500F03	15	●	15	93.7	62	153	2.73

● : Line up

STANDARD CUTTING CONDITIONS

See more information

e-catalog



FDC-S L/D=5

Solid drill, L/D = 5, with coolant hole, for cast iron and Aluminium alloy

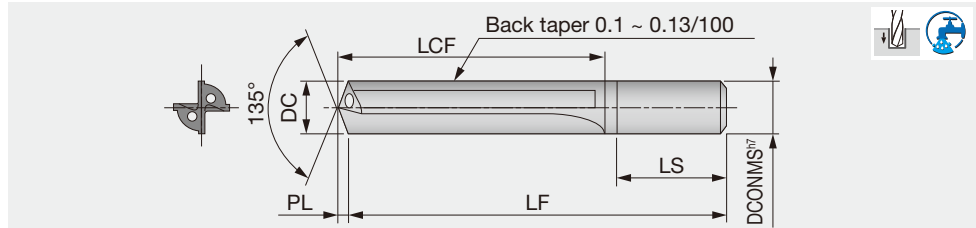

Designation	DC	G1F	DCONMS	LCF	LS	LF	PL	Designation	DC	G1F	DCONMS	LCF	LS	LF	PL
FDC0510S	5.1	●	6	45.1	40	85	1.06	FDC1250S	12.5	●	13	102.6	50	160	2.59
FDC0600S	6	●	6	49.2	40	90	1.24	FDC1300S	13	●	13	106.7	50	160	2.69
FDC0840S	8.4	●	9	69.7	44	115	1.74	FDC1350S	13.5	●	14	110.8	52	170	2.8
FDC0860S	8.6	●	9	73.8	44	120	1.78	FDC1400S	14	●	14	114.9	52	170	2.9
FDC1050S	10.5	●	11	86.2	46	140	2.17	FDC1450S	14.5	●	15	119	54	180	3
FDC1100S	11	●	11	90.3	46	140	2.28	FDC1500S	15	●	15	123.1	54	180	3.11
FDC1150S	11.5	●	12	94.4	48	150	2.38	FDC1550S	15.5	●	16	127.2	56	190	3.21
FDC1200S	12	●	12	98.5	48	150	2.49	FDC1600S	16	●	16	131.3	56	190	3.31

DC	Tolerance (mm)
5 ≤ DC ≤ 6	+0.02 ~ +0.01
6 < DC ≤ 16	+0.025 ~ +0.015

● : Line up

STANDARD CUTTING CONDITIONS

Please scan below.

e-catalog



FDC-L L/D=8

Solid drill, L/D = 8, with coolant hole, for cast iron and Aluminium alloy

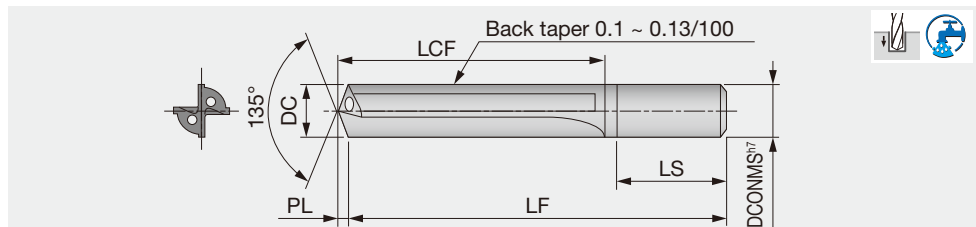

Designation	DC	G1F	DCONMS	LCF	LS	LF	PL	Designation	DC	G1F	DCONMS	LCF	LS	LF	PL
FDC0500L	5	●	5	56	38	95	1.04	FDC0750L	7.5	●	8	84.6	42	125	1.55
FDC0550L	5.5	●	6	62.1	40	105	1.14	FDC0780L	7.8	●	8	89.6	42	130	1.62
FDC0600L	6	●	6	67.2	40	110	1.24	FDC0800L	8	●	8	89.7	42	130	1.66
FDC0620L	6.2	●	7	73.3	40	115	1.28	FDC0850L	8.5	●	9	95.8	44	140	1.76
FDC0650L	6.5	●	7	73.4	40	115	1.35	FDC0860L	8.6	●	9	100.8	44	145	1.78
FDC0680L	6.8	●	7	78.4	40	120	1.41	FDC0900L	9	●	9	100.9	44	145	1.86
FDC0700L	7	●	7	78.5	40	120	1.45	FDC0950L	9.5	●	10	107	44	150	1.97
								FDC1000L	10	●	10	112.1	46	160	2.07

DC	Tolerance (mm)
5 ≤ DC ≤ 6	+0.02 ~ +0.01
6 < DC ≤ 10	+0.025 ~ +0.015

Coolant

- Supply coolant through the inside of a drill.
- The coolant pressure should be 0.5 to 1 MPa.
- Use water-soluble coolant containing a large amount of extreme pressure additive.

● : Line up

STANDARD CUTTING CONDITIONS

Please scan below.

e-catalog



SOLIDDRILL

DMX (S type)

Solid drill, L/D = 2, without coolant hole

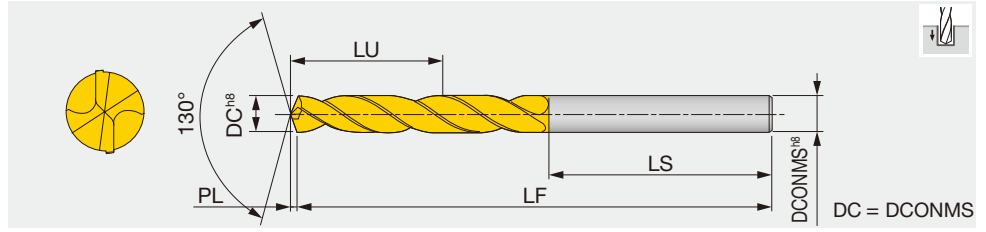

Designation	DC	AH170	DCONMS	LU	LS	LF	PL
DMX037S	3.7	●	3.7	20.9	32	52	0.86
DMX038S	3.8	●	3.8	22.9	33	55	0.89
DMX039S	3.9	●	3.9	22.9	33	55	0.91
DMX040S	4	●	4	22.9	33	55	0.93
DMX051S	5.1	●	5.1	27.2	36	62	1.19
DMX061S	6.1	●	6.1	32.4	39	70	1.42
DMX062S	6.2	●	6.2	32.5	39	70	1.45
DMX068S	6.8	●	6.8	35.6	40	74	1.59
DMX070S	7	●	7	35.6	40	74	1.63

Designation	DC	AH170	DCONMS	LU	LS	LF	PL
DMX080S	8	●	8	38.9	42	79	1.87
DMX085S	8.5	●	8.5	39	42	79	1.98
DMX090S	9	●	9	42.1	44	84	2.1
DMX111S	11.1	●	11.1	49.6	48	95	2.59
DMX130S	13	●	13	54	51	102	3.03
DMX140S	14	●	14	57.3	53	107	3.26
DMX145S	14.5	●	14.5	59.4	55	111	3.38
DMX165S	16.5	●	16.5	63.9	59	119	3.85

● : Line up
• Cutting fluid should be sufficiently supplied to the drill point and the entrance of the hole. • Use a water-soluble cutting fluid.

STANDARD CUTTING CONDITIONS

See more information

e-catalog



DMX (M type)

Solid drill, L/D = 3, without coolant hole

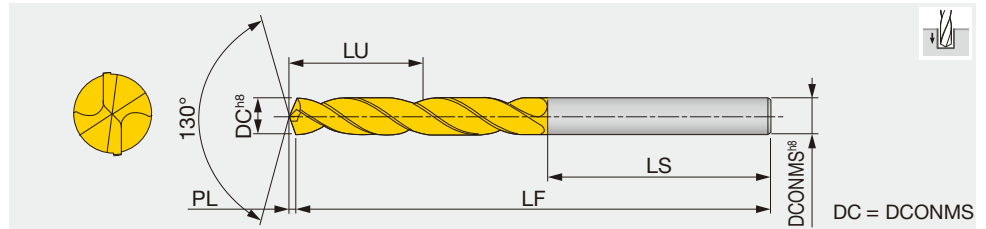

Designation	DC	AH170	DCONMS	LU	LS	LF	PL
DMX030M	3	●	3	21.7	39	60	0.7
DMX034M	3.4	●	3.4	24.8	36	60	0.79
DMX037M	3.7	●	3.7	27.9	33	60	0.86
DMX039M	3.9	●	3.9	27.9	33	60	0.91
DMX040M	4	●	4	27.9	33	60	0.93
DMX041M	4.1	●	4.1	30	34	63	0.96
DMX043M	4.3	●	4.3	30	34	63	1
DMX048M	4.8	●	4.8	33.1	36	68	1.12
DMX050M	5	●	5	33.2	36	68	1.17
DMX051M	5.1	●	5.1	35.2	38	72	1.19
DMX055M	5.5	●	5.5	35.3	38	72	1.28

Designation	DC	AH170	DCONMS	LU	LS	LF	PL
DMX058M	5.8	●	5.8	37.4	38	74	1.35
DMX061M	6.1	●	6.1	42.4	40	81	1.42
DMX068M	6.8	●	6.8	44.6	40	83	1.59
DMX078M	7.8	●	7.8	49.8	42	90	1.82
DMX080M	8	●	8	49.9	42	90	1.87
DMX110M	11	●	11	70.6	46	114	2.56
DMX127M	12.7	●	12.7	81	59	137	2.96
DMX138M	13.8	●	13.8	89.2	61	147	3.22
DMX148M	14.8	●	14.8	94.5	62	153	3.45
DMX165M	16.5	●	16.5	105.9	65	167	3.85

● : Line up
• Cutting fluid should be sufficiently supplied to the drill point and the entrance of the hole. • Use a water-soluble cutting fluid.

STANDARD CUTTING CONDITIONS

See more information

e-catalog



DMX-FS

Solid drill, L/D = 2, without coolant hole

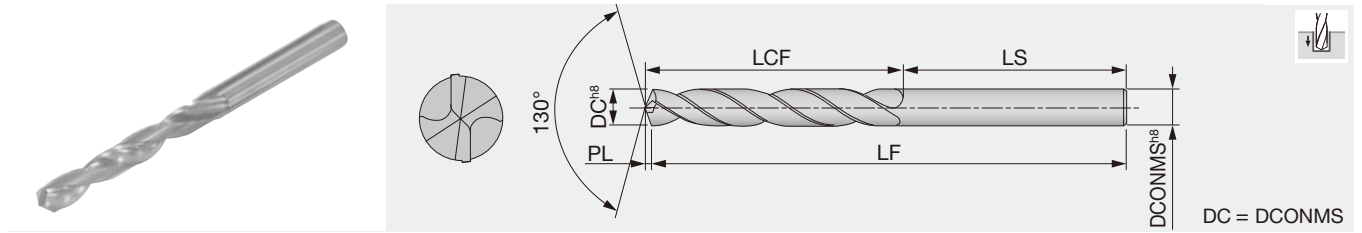

Designation	DC	MD20	LCF	LS	LF	PL	DC	
							Tolerance h8(mm)	
DMX0600FS	6	●	29.4	38	66	1.4	6	0 ~ -0.018
DMX0700FS	7	●	35.6	40	74	1.63	7, 10	0 ~ -0.022
DMX1000FS	10	●	45.3	46	89	2.33		

● : Line up

STANDARD CUTTING CONDITIONS

Please scan below.

e-catalog



DMX-FM

Solid drill, L/D = 3, without coolant hole

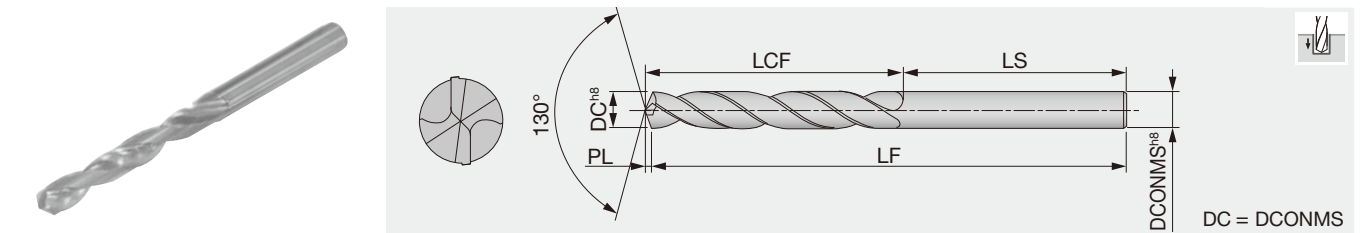

Designation	DC	MD20	LCF	LS	LF	PL	DC	
							Tolerance h8(mm)	
DMX0600FM	6	●	42.4	40	81	1.4	6	0 ~ -0.018
DMX1250FM	12.5	●	78.9	59	135	2.91	12.5	0 ~ -0.027

● : Line up

STANDARD CUTTING CONDITIONS

Please scan below.

e-catalog



Grade
Insert
Ext. Toolholder
Int. Toolholder
Threading
Grooving
Miniature tool
Milling cutter
Endmill
Drilling tool
Tooling System
User's Guide
Index

A
B
C
D
E
F
G
H
I
J
K
L
M

SOLIDDRILL

DMX-FL

Solid drill, L/D = 5, without coolant hole

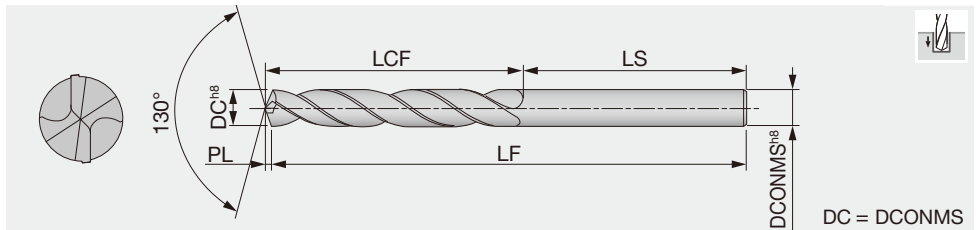
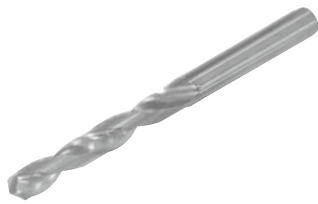

Designation	DC	MD20	LCF	LS	LF	PL	DC	Tolerance h8(mm)
DMX0300FL	3	●	27.7	39	66	0.7	3	0 ~ -0.014
DMX0400FL	4	●	35.9	33	68	0.93	4, 5	0 ~ -0.018
DMX0500FL	5	●	43.2	36	78	1.17	8.5	0 ~ -0.022
DMX0850FL	8.5	●	72	43	113	1.98		

● : Line up

STANDARD CUTTING CONDITIONS

Please scan below.

e-catalog



FDS

Solidrill, L/D = 3, without oil hole, for pre-tap hole drilling

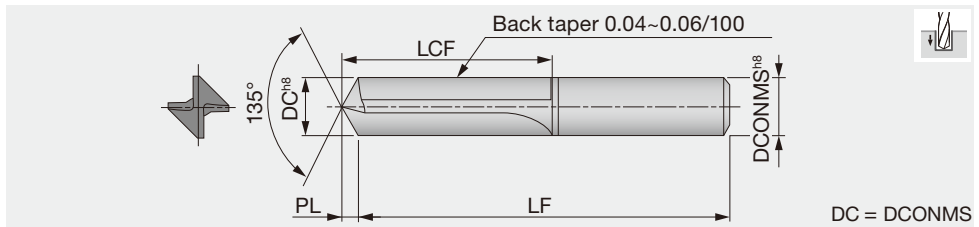
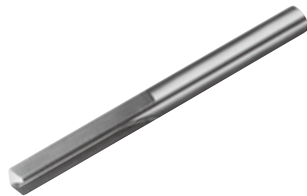

For bolt holes

Designation	DC	G1F	DCONMS	LCF	LF	PL	DC	Tolerance h8(mm)
FDS1100	11	●	11	57.3	120	2.28	11	0 ~ -0.027

● : Line up

STANDARD CUTTING CONDITIONS

Please scan below.

e-catalog



Solid drill, L/D = 3, DIN shank, without coolant hole, DIN shank

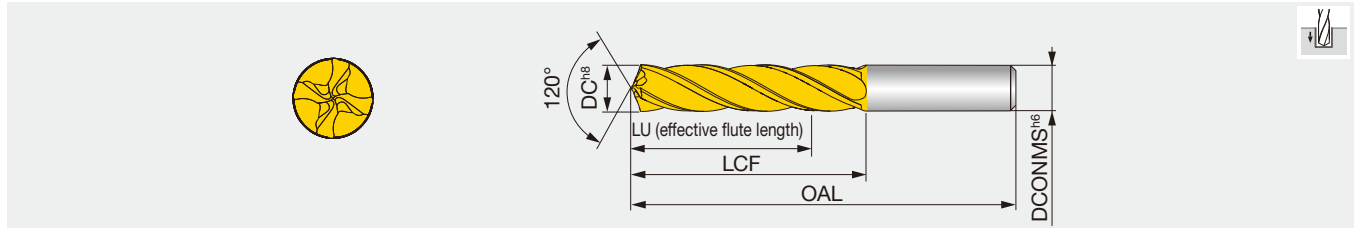

Designation	DC	AH9130	DCONMS	LU	LCF	OAL	Designation	DC	AH9130	DCONMS	LU	LCF	OAL
DSQ060-018-06E3	6	●	6	24	30	80	DSQ108-033-11E3	10.8	●	11	43	54	124
DSQ068-021-07E3	6.8	●	7	27	34	84	DSQ120-036-12E3	12	●	12	48	60	130
DSQ085-026-09E3	8.5	●	9	34	43	93	DSQ130-039-13E3	13	●	13	52	65	135
DSQ090-027-09E3	9	●	9	36	45	95	DSQ140-042-14E3	14	●	14	56	70	140
DSQ100-030-10E3	10	●	10	40	50	100	DSQ160-048-16E3	16	●	16	64	80	150
DSQ105-032-11E3	10.5	●	11	42	53	123							

● : Line up

DSQ-E5

Solid drill, L/D = 5, DIN shank, without coolant hole

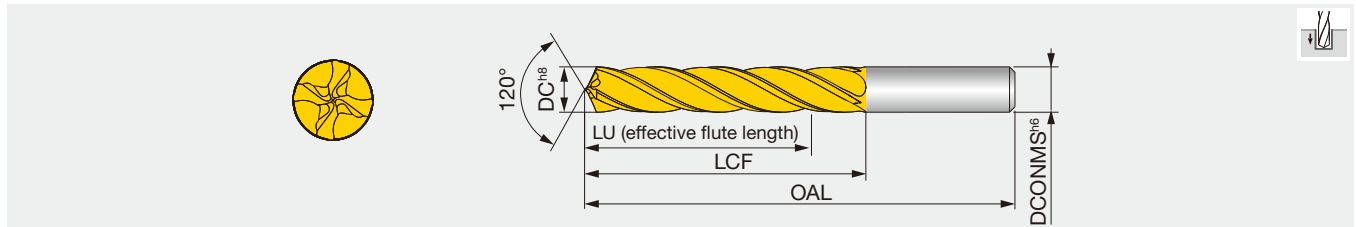

Designation	DC	AH9130	DCONMS	LU	LCF	OAL	Designation	DC	AH9130	DCONMS	LU	LCF	OAL
DSQ060-030-06E5	6	●	6	36	42	92	DSQ105-053-11E5	10.5	●	11	63	74	144
DSQ068-034-07E5	6.8	●	7	41	48	98	DSQ120-060-12E5	12	●	12	72	84	154
DSQ085-043-09E5	8.5	●	9	51	60	110	DSQ160-080-16E5	16	●	16	96	112	182

● : Line up

STANDARD CUTTING CONDITIONS

ISO	Workpiece material	Brinell hardness (HB)	Cutting speed Vc (m/min)	Feed: f (mm/rev)	
				ø6 - ø9.9	ø10 - ø16
K	Grey cast irons FC300, etc. 250, etc.	- 200	60 - 120	0.2 - 0.8	0.3 - 1.0
	Ductile cast irons FCD450, etc. 450-10S, etc.	- 300	60 - 120	0.2 - 0.8	0.3 - 1.0

- The cutting parameters shown in the table are a starting guideline. Values should be varied depending on the power or rigidity of the machine. Optimum conditions should be selected depending on the actual chip control or damage on edges.
- When using the smaller diameter tools in each range, set the feed "f" to the lower values.
- When drilling with a depth deeper than L/D = 3, a pecking cycle or dwell operation should be considered depending on the actual chip control.





TungSix-Drill

Indexable drill



TUNGSIX-DRILL

Indexable drill with 6-corner inserts for high productivity



ø20 mm - ø54 mm / L/D = 2, 3, 4

J006
J060 -



TUNGDRILLTWISTED

Indexable drill with 4-corner inserts for various drilling applications



ø12.5 mm - ø54 mm / L/D = 2, 3, 4, 5

J006
J068 -

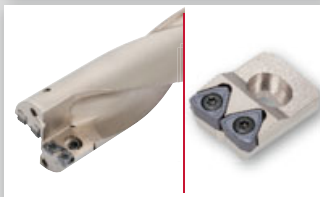

TUNGDRILLBIG

Large diameter drill with cartridges for TungSix-Drill and TungDrillTwisted inserts



ø55 mm - ø80 mm / L/D = 2.5

J006
J081 -

TUNGSIX-DRILL



Indexable drill

6 cornered insert with high performance and high economical solution

Double-sided insert with 6-cutting edges

TungSixDrill is the first indexable drill in the world to adapt double-sided inserts with 6-cutting edges, reducing the insert consumption for the customers.

One insert type for both the central and peripheral pockets

One side has the central edge and other side has the peripheral edge.

Low cutting force even with double sided insert

The cutting forces are almost equal to competitors positive single sided inserts, especially at higher feed rates, thus complementing higher productivity.

Peripheral side

Central side

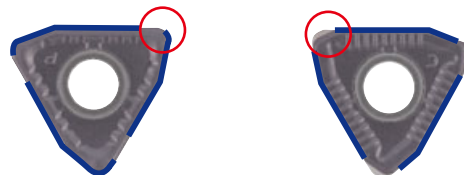

Optimal distance between each cutting edge

Prevents the overlapping of damaged edges



Reference pages: [J061](#) - [J067](#)

TUNGSIK-DRILL

TDS-F L/D=2

Indexable drill, L/D = 2, flat cotter

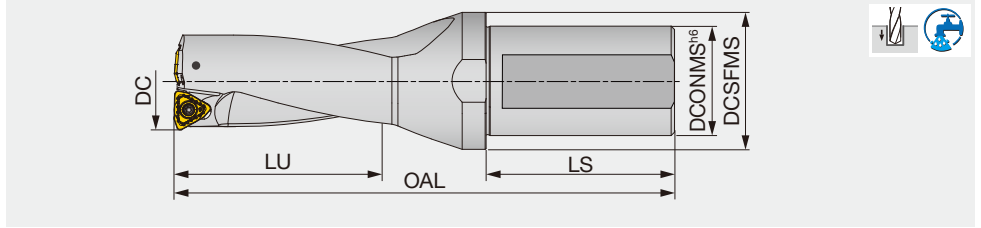

Designation	DC	DCONMS	DCSFMS	LU	LS	OAL	Max. offset (radial)	WT(kg)	Insert
TDS200F25-2	20	25	32	40.8	54	115.8	1	0.3	WWMU05X205R-D*
TDS205F25-2	20.5	25	32	41.8	54	117.3	0.9	0.3	WWMU05X205R-D*
TDS210F25-2	21	25	32	42.8	54	118.8	0.8	0.3	WWMU05X205R-D*
TDS215F25-2	21.5	25	32	43.8	54	119.8	0.6	0.3	WWMU05X205R-D*
TDS220F25-2	22	25	32	44.8	54	120.8	0.5	0.3	WWMU05X205R-D*
TDS225F25-2	22.5	25	37	45.8	54	122.3	0.4	0.3	WWMU05X205R-D*
TDS230F25-2	23	25	37	46.8	54	123.8	0.3	0.4	WWMU05X205R-D*
TDS235F25-2	23.5	25	37	47.8	54	124.8	0.2	0.4	WWMU05X205R-D*
TDS240F25-2	24	25	37	48.9	54	125.9	1.2	0.4	WWMU060306R-D*
TDS245F25-2	24.5	25	37	49.9	54	127.4	1	0.4	WWMU060306R-D*
TDS250F25-2	25	25	37	50.9	54	128.9	0.8	0.4	WWMU060306R-D*
TDS255F25-2	25.5	25	37	51.9	54	130.4	0.6	0.4	WWMU060306R-D*
TDS260F25-2	26	25	37	52.9	54	131.9	0.5	0.4	WWMU060306R-D*
TDS270F32-2	27	32	40	54.9	59	138.9	0.3	0.6	WWMU060306R-D*
TDS280F32-2	28	32	40	57.1	59	142.1	1.3	0.6	WWMU08X408R-D*
TDS290F32-2	29	32	40	59.1	59	144.1	1.1	0.7	WWMU08X408R-D*
TDS300F32-2	30	32	40	61.1	59	147.1	0.8	0.7	WWMU08X408R-D*
TDS310F32-2	31	32	40	63.1	59	150.1	0.5	0.7	WWMU08X408R-D*
TDS320F32-2	32	32	40	65.1	59	152.1	0.2	0.8	WWMU08X408R-D*
TDS330F40-2	33	40	50	67.3	69	165.3	1.7	1.2	WWMU09X510R-D*
TDS340F40-2	34	40	50	69.3	69	168.3	1.4	1.2	WWMU09X510R-D*
TDS350F40-2	35	40	50	71.3	69	171.3	1.2	1.2	WWMU09X510R-D*
TDS360F40-2	36	40	50	73.3	69	174.3	0.9	1.3	WWMU09X510R-D*
TDS370F40-2	37	40	50	75.3	69	175.3	0.7	1.3	WWMU09X510R-D*
TDS380F40-2	38	40	50	77.3	69	178.3	0.4	1.3	WWMU09X510R-D*
TDS390F40-2	39	40	50	79.6	69	180.6	2.2	1.4	WWMU11X512R-D*
TDS400F40-2	40	40	50	81.6	69	183.6	1.9	1.4	WWMU11X512R-D*
TDS410F40-2	41	40	50	83.6	69	187.6	1.7	1.5	WWMU11X512R-D*
TDS420F40-2	42	40	55	85.6	69	189.6	1.5	1.6	WWMU11X512R-D*
TDS430F40-2	43	40	55	87.6	69	192.6	1.3	1.6	WWMU11X512R-D*
TDS440F40-2	44	40	55	89.6	69	194.6	1	1.7	WWMU11X512R-D*
TDS450F40-2	45	40	55	91.6	69	197.6	0.7	1.7	WWMU11X512R-D*
TDS460F40-2	46	40	55	93.6	69	200.6	0.4	1.8	WWMU11X512R-D*
TDS470F40-2	47	40	55	95.8	69	202.8	2.6	1.9	WWMU13X512R-D*
TDS480F40-2	48	40	55	97.8	69	205.8	2.4	1.9	WWMU13X512R-D*
TDS490F40-2	49	40	55	99.8	69	207.8	2.2	1.9	WWMU13X512R-D*
TDS500F40-2	50	40	55	101.8	69	210.8	2	2	WWMU13X512R-D*
TDS510F40-2	51	40	55	103.8	69	214.8	1.7	2.1	WWMU13X512R-D*
TDS520F40-2	52	40	55	105.8	69	216.8	1.5	2.2	WWMU13X512R-D*
TDS530F40-2	53	40	55	107.8	69	219.8	1.3	2.3	WWMU13X512R-D*
TDS540F40-2	54	40	55	109.8	69	221.8	1	2.4	WWMU13X512R-D*

SPARE PARTS

Designation	Clamping screw	Wrench
TDS200... - TDS235...	CSPB-2.2	IP-7D
TDS240... - TDS270...	CSPB-2.5	IP-8D
TDS280... - TDS320...	CSTB-3	T-9D
TDS330... - TDS380...	CSTB-4	T-15D
TDS390... - TDS540...	CSTB-5	T-20D

Tool diameter	Tool diameter tolerance	Hole diameter tolerance*
ø20 - ø27	+ 0.2 / 0	+ 0.25 / 0
ø28 - ø54	+ 0.2 / 0	+ 0.3 / 0

*Just for reference

Recommended clamping torque (N·m): CSPB-2.2 = 1, CSPB-2.5 = 1.3, CSTB-3 = 2.3, CSTB-4 = 3.5, CSTB-5 = 5

Reference pages: Inserts, Standard cutting conditions → **J064 - J065**



TUNGSIX-DRILL

TDS-F L/D=3

Indexable drill, L/D = 3, flat cotter

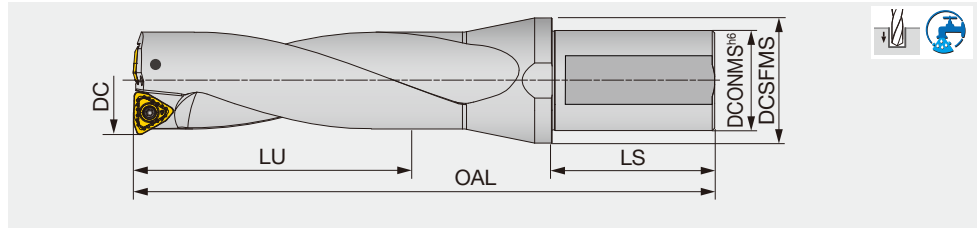

Designation	DC	DCONMS	DCSFMS	LU	LS	OAL	Max. offset (radial)	WT(kg)	Insert
TDS200F25-3	20	25	32	60.8	54	135.8	1	0.3	WWMU05X205R-D*
TDS205F25-3	20.5	25	32	62.3	54	136.8	0.9	0.3	WWMU05X205R-D*
TDS209F25-3 (1)	20.9	25	32	63.5	54	138.8	0.8	0.3	WWMU05X205R-D*
TDS210F25-3	21	25	32	63.8	54	138.8	0.8	0.4	WWMU05X205R-D*
TDS215F25-3	21.5	25	32	65.3	54	140.8	0.6	0.4	WWMU05X205R-D*
TDS220F25-3	22	25	32	66.8	54	141.8	0.5	0.4	WWMU05X205R-D*
TDSU0875F25-3 (2)	22.2	25	32	66.8	54	141.8	0.4	0.4	WWMU05X205R-D*
TDS225F25-3	22.5	25	37	68.3	54	144.8	0.4	0.4	WWMU05X205R-D*
TDS230F25-3	23	25	37	69.8	54	145.8	0.3	0.4	WWMU05X205R-D*
TDS235F25-3	23.5	25	37	71.3	54	147.8	0.2	0.4	WWMU05X205R-D*
TDS239F25-3 (1)	23.9	25	37	72.6	54	149.9	1.2	0.4	WWMU060306R-D*
TDS240F25-3	24	25	37	72.9	54	149.9	1.2	0.4	WWMU060306R-D*
TDS245F25-3	24.5	25	37	74.4	54	151.9	1	0.5	WWMU060306R-D*
TDS250F25-3	25	25	37	75.9	54	153.9	0.8	0.5	WWMU060306R-D*
TDS255F25-3	25.5	25	37	77.4	54	154.9	0.6	0.5	WWMU060306R-D*
TDS260F25-3 (1)	26	25	37	78.9	54	156.9	0.5	0.5	WWMU060306R-D*
TDS264F32-3	26.4	32	40	80.1	59	163.4	0.4	0.6	WWMU060306R-D*
TDS265F32-3	26.5	32	40	80.4	59	163.4	0.4	0.6	WWMU060306R-D*
TDS270F32-3	27	32	40	81.9	59	164.9	0.3	0.6	WWMU060306R-D*
TDS275F32-3	27.5	32	40	83.1	59	168.1	0	0.6	WWMU08X408R-D*
TDS280F32-3	28	32	40	85.1	59	169.1	1.3	0.7	WWMU08X408R-D*
TDS285F32-3	28.5	32	40	86.1	59	171.1	1.1	0.7	WWMU08X408R-D*
TDSU1125F32-3 (2)	28.6	32	40	87.1	59	172.1	1.1	0.7	WWMU08X408R-D*
TDS290F32-3	29	32	40	88.1	59	172.1	1.1	0.7	WWMU08X408R-D*
TDS295F32-3	29.5	32	40	89.1	59	176.1	0.8	0.7	WWMU08X408R-D*
TDS300F32-3	30	32	40	91.1	59	177.1	0.8	0.8	WWMU08X408R-D*
TDS305F32-3	30.5	32	40	92.1	59	181.1	0.5	0.8	WWMU08X408R-D*
TDS310F32-3	31	32	40	94.1	59	181.1	0.5	0.8	WWMU08X408R-D*
TDSU1250F32-3 (2)	31.8	32	40	96.1	59	184.1	0.2	0.8	WWMU08X408R-D*
TDS320F32-3	32	32	40	97.1	59	184.1	0.2	0.9	WWMU08X408R-D*
TDS330F40-3	33	40	50	100.3	69	198.3	1.7	1.3	WWMU09X510R-D*
TDS340F40-3	34	40	50	103.3	69	201.3	1.4	1.3	WWMU09X510R-D*
TDS350F40-3	35	40	50	106.3	69	205.3	1.2	1.3	WWMU09X510R-D*
TDS360F40-3	36	40	50	109.3	69	209.3	0.9	1.4	WWMU09X510R-D*
TDS370F40-3	37	40	50	112.3	69	212.3	0.7	1.4	WWMU09X510R-D*
TDS380F40-3	38	40	50	115.3	69	216.3	0.4	1.5	WWMU09X510R-D*
TDS390F40-3	39	40	50	118.6	69	219.6	2.2	1.6	WWMU11X512R-D*
TDS400F40-3	40	40	50	121.6	69	223.6	1.9	1.6	WWMU11X512R-D*
TDS410F40-3	41	40	50	124.6	69	227.6	1.7	1.7	WWMU11X512R-D*
TDS420F40-3	42	40	55	127.6	69	230.6	1.5	1.8	WWMU11X512R-D*
TDS430F40-3	43	40	55	130.6	69	234.6	1.3	1.8	WWMU11X512R-D*
TDS440F40-3	44	40	55	133.6	69	237.6	1	1.9	WWMU11X512R-D*
TDS450F40-3	45	40	55	136.6	69	242.6	0.7	2	WWMU11X512R-D*
TDS460F40-3	46	40	55	139.6	69	246.6	0.4	2.1	WWMU11X512R-D*
TDS470F40-3	47	40	55	142.8	69	249.8	2.6	2.2	WWMU13X512R-D*
TDS480F40-3	48	40	55	145.8	69	253.8	2.4	2.3	WWMU13X512R-D*
TDS490F40-3	49	40	55	148.8	69	256.8	2.2	2.3	WWMU13X512R-D*
TDS500F40-3	50	40	55	151.8	69	260.8	2	2.4	WWMU13X512R-D*
TDS510F40-3	51	40	55	154.8	69	264.8	1.7	2.5	WWMU13X512R-D*
TDS520F40-3	52	40	55	157.8	69	267.8	1.5	2.6	WWMU13X512R-D*
TDS530F40-3	53	40	55	160.8	69	271.8	1.3	2.7	WWMU13X512R-D*
TDS540F40-3	54	40	55	163.8	69	274.8	1	2.9	WWMU13X512R-D*

(1) For pre thread hole: DC = 20.9 mm: M24x3, DC = 23.9 mm: M27x3, DC = 26.4 mm: M30x3.5
 (2) For inch size: DC: 22.2 mm = 0.875", DC: 28.6 mm = 1.125", DC: 31.8 mm = 1.250"

SPARE PARTS

Designation	Clamping screw	Wrench
TDS200... - TDS235...	CSPB-2.2	IP-7D
TDS240... - TDS270...	CSPB-2.5	IP-8D
TDS280... - TDS320...	CSTB-3	T-9D
TDS330... - TDS380...	CSTB-4	T-15D
TDS390... - TDS540...	CSTB-5	T-20D

Tool diameter	Tool diameter tolerance	Hole diameter tolerance*
ø20 - ø27	+ 0.2 / 0	+ 0.25 / 0
ø28 - ø54	+ 0.2 / 0	+ 0.3 / 0

*Just for reference

Recommended clamping torque (N·m): CSPB-2.2 = 1, CSPB-2.5 = 1.3, CSTB-3 = 2.3, CSTB-4 = 3.5, CSTB-5 = 5

Reference pages: Inserts, Standard cutting conditions →

J064 - J065

TDS-F L/D=4

Indexable drill, L/D = 4, flat cotter

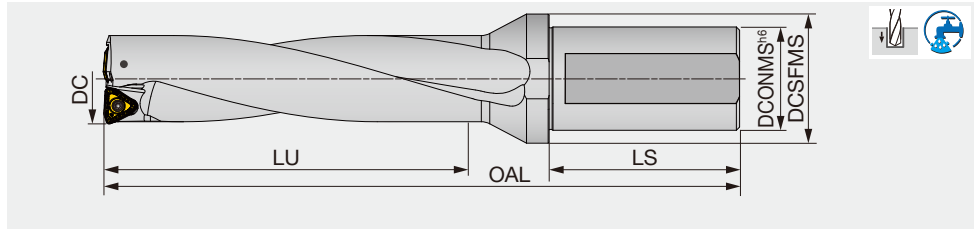

Designation	DC	DCONMS	DCSFMS	LU	LS	OAL	Max. offset (radial)	WT(kg)	Insert
TDS200F25-4	20	25	32	80.8	54	155.8	1	0.4	WWMU05X205R-D*
TDS205F25-4	20.5	25	32	82.8	54	157.8	0.9	0.4	WWMU05X205R-D*
TDS210F25-4	21	25	32	84.8	54	159.8	0.8	0.4	WWMU05X205R-D*
TDS215F25-4	21.5	25	32	86.8	54	161.8	0.6	0.4	WWMU05X205R-D*
TDS220F25-4	22	25	32	88.8	54	163.8	0.5	0.4	WWMU05X205R-D*
TDS225F25-4	22.5	25	37	90.8	54	166.3	0.4	0.4	WWMU05X205R-D*
TDS230F25-4	23	25	37	92.8	54	168.8	0.3	0.4	WWMU05X205R-D*
TDS235F25-4	23.5	25	37	94.8	54	171.3	0.2	0.5	WWMU05X205R-D*
TDS240F25-4	24	25	37	96.9	54	173.9	1.2	0.5	WWMU060306R-D*
TDS245F25-4	24.5	25	37	98.9	54	176.4	1	0.5	WWMU060306R-D*
TDS250F25-4	25	25	37	100.9	54	178.9	0.8	0.5	WWMU060306R-D*
TDS255F25-4	25.5	25	37	102.9	54	180.9	0.6	0.6	WWMU060306R-D*
TDS260F25-4	26	25	37	104.9	54	182.9	0.5	0.5	WWMU060306R-D*
TDS270F32-4	27	32	40	108.9	59	191.9	0.3	0.7	WWMU060306R-D*
TDS280F32-4	28	32	40	113.1	59	197.1	1.3	0.8	WWMU08X408R-D*
TDS290F32-4	29	32	40	117.1	59	201.1	1.1	0.8	WWMU08X408R-D*
TDS300F32-4	30	32	40	121.1	59	207.1	0.8	0.9	WWMU08X408R-D*
TDS310F32-4	31	32	40	125.1	59	212.1	0.5	0.9	WWMU08X408R-D*
TDS320F32-4	32	32	40	129.1	59	216.1	0.2	1	WWMU08X408R-D*
TDS330F40-4	33	40	50	133.3	69	231.3	1.7	1.4	WWMU09X510R-D*
TDS340F40-4	34	40	50	137.3	69	235.3	1.4	1.4	WWMU09X510R-D*
TDS350F40-4	35	40	50	141.3	69	240.3	1.2	1.4	WWMU09X510R-D*
TDS360F40-4	36	40	50	145.3	69	245.3	0.9	1.5	WWMU09X510R-D*
TDS370F40-4	37	40	50	149.3	69	249.3	0.7	1.5	WWMU09X510R-D*
TDS380F40-4	38	40	50	153.3	69	254.3	0.4	1.7	WWMU09X510R-D*
TDS390F40-4	39	40	50	157.5	69	259	2.2	1.8	WWMU11X512R-D*
TDS400F40-4	40	40	50	161.5	69	264	1.9	1.8	WWMU11X512R-D*
TDS410F40-4	41	40	50	165.5	69	269	1.7	1.9	WWMU11X512R-D*
TDS420F40-4	42	40	55	169.5	69	273	1.5	2	WWMU11X512R-D*
TDS430F40-4	43	40	55	173.5	69	278	1.3	2	WWMU11X512R-D*
TDS440F40-4	44	40	55	177.5	69	282	1	2.1	WWMU11X512R-D*
TDS450F40-4	45	40	55	181.5	69	288	0.7	2.3	WWMU11X512R-D*
TDS460F40-4	46	40	55	185.5	69	293	0.4	2.4	WWMU11X512R-D*
TDS470F40-4	47	40	55	189.8	69	297.3	2.6	2.5	WWMU13X512R-D*
TDS480F40-4	48	40	55	193.8	69	302.3	2.4	2.7	WWMU13X512R-D*
TDS490F40-4	49	40	55	197.8	69	306.3	2.2	2.7	WWMU13X512R-D*
TDS500F40-4	50	40	55	201.8	69	311.3	2	2.8	WWMU13X512R-D*
TDS510F40-4	51	40	55	205.8	69	316.3	1.7	2.9	WWMU13X512R-D*
TDS520F40-4	52	40	55	209.8	69	320.3	1.5	3	WWMU13X512R-D*
TDS530F40-4	53	40	55	213.8	69	325.3	1.3	3.1	WWMU13X512R-D*
TDS540F40-4	54	40	55	217.8	69	329.3	1	3.4	WWMU13X512R-D*

SPARE PARTS

Designation	Clamping screw	Wrench
TDS200... - TDS235...	CSPB-2.2	IP-7D
TDS240... - TDS270...	CSPB-2.5	IP-8D
TDS280... - TDS320...	CSTB-3	T-9D
TDS330... - TDS380...	CSTB-4	T-15D
TDS390... - TDS540...	CSTB-5	T-20D

Tool diameter	Tool diameter tolerance	Hole diameter tolerance*
ø20 - ø27	+ 0.2 / 0	+ 0.3 / 0
ø28 - ø54	+ 0.2 / 0	+ 0.35 / 0

*Just for reference

Recommended clamping torque (N·m): CSPB-2.2 = 1, CSPB-2.5 = 1.3, CSTB-3 = 2.3, CSTB-4 = 3.5, CSTB-5 = 5

Reference pages: Inserts, Standard cutting conditions → **J064 - J065**



STANDARD CUTTING CONDITIONS

Reamer
 Deep Hole Drill
 Indexable Drill
 4-effective Drill
 2-effective Drill

ISO	Workpiece materials	Hardness	Priority	Chip breakers	Grade	Cutting speed Vc (m/min)
P	Low carbon steels (C < 0.3) SS400, SM490, S25C, etc. St42-1, St52-3, C25, etc.	- 200 HB	First choice	DS	AH6030	160 - 250
			Wear resistance	DJ	AH9030	160 - 320
	Carbon steels (C > 0.3) S45C, S55C, etc. C45, C55, etc.	- 300 HB	First choice	DJ	AH9030	80 - 250
			Fracture resistance	DJ	AH3135	80 - 250
	Low alloy steels SCM415, etc.	- 200 HB	First choice	DS	AH6030	160 - 250
			Wear resistance	DJ	AH9030	160 - 250
Alloy steels SCM440, SCr420, etc. 42CrMo4, 20Cr4, etc.	- 300 HB	First choice	DJ	AH9030	80 - 200	
		Fracture resistance	DJ	AH3135	80 - 200	
M	Stainless steels (Austenitic) SUS304, SUS316, etc. X5CrNi18-9, X5CrNiMo17-12-2, etc.	- 200 HB	First choice	DS	AH6030	100 - 200
			Fracture resistance	DJ	AH3135	100 - 200
	Stainless steels (Martensitic and ferritic) SUS430, SUS416, etc. X6Cr17, X20Cr13, etc.	- 200 HB	First choice	DS	AH6030	100 - 200
			Fracture resistance	DJ	AH3135	100 - 200
	Stainless steels (Precipitation hardening) SUS630, etc. X5CrNiCuNb16-4, etc.	-	First choice	DS	AH6030	80 - 120
			Fracture resistance	DJ	AH3135	80 - 120
K	Grey cast irons FC250, etc. GG25, etc.	150 - 250 HB	First choice	DJ	AH9030	80 - 250
			Fracture resistance	DJ	AH3135	80 - 200
	Ductile cast irons FCD700, etc. GGG70, etc.	150 - 250 HB	First choice	DJ	AH9030	80 - 200
			Fracture resistance	DJ	AH3135	80 - 150
N	Aluminium alloy	-	First choice	DS	AH6030	200 - 400
S	Heat resistant alloy Inconel718, etc	- 40 HRC	First choice	DS	AH6030	20 - 60
			Fracture resistance	DJ	AH3135	20 - 60
	Titanium alloys Ti-6Al-4V, etc.	- 40 HRC	First choice	DS	AH6030	40 - 120
			Fracture resistance	DJ	AH3135	40 - 120
H	Hardened steel Over 40HRC	- 50 HRC	First choice	DJ	AH9030	50 - 100
			Fracture resistance	DJ	AH3135	40 - 80

INSERT

DJ

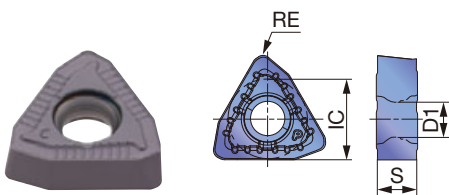

P	Steel	☆	★						
M	Stainless	★	☆						
K	Cast iron	☆	★						
N	Non-ferrous	☆	☆						
S	Superalloys	★	☆						
H	Hard materials	★	☆						

★ : First choice
☆ : Second choice

Designation	IC	S	Coated		D1	RE	DCN	DCX
			AH3135	AH9030				
WWMU05X205R-DJ	5.8	2.4	●	●	2.5	0.5	20	23.5
WWMU060306R-DJ	6.7	2.9	●	●	3	0.6	23.9	27
WWMU08X408R-DJ	8	3.9	●	●	3.4	0.8	27.5	32
WWMU09X510R-DJ	9.7	4.9	●	●	4.4	1	33	38
WWMU11X512R-DJ	11.3	5.7	●	●	5.5	1.2	39	46
WWMU13X512R-DJ	13	5.7	●	●	5.5	1.2	47	54

● : Line up

Feed: *f* (mm/rev)

L/D = 2, 3		L/D = 4			
DC (mm)		DC (mm)			
ø20 - ø27.5	ø28 - ø38	ø39 - ø54	ø20 - ø27	ø28 - ø38	ø39 - ø54
0.04 - 0.1	0.04 - 0.1	0.04 - 0.1	0.04 - 0.1	0.04 - 0.1	0.04 - 0.1
0.04 - 0.1	0.04 - 0.1	0.04 - 0.1	0.04 - 0.1	0.04 - 0.1	0.04 - 0.1
0.06 - 0.15	0.06 - 0.16	0.08 - 0.18	0.06 - 0.15	0.06 - 0.15	0.08 - 0.17
0.04 - 0.12	0.04 - 0.13	0.04 - 0.15	0.04 - 0.12	0.04 - 0.13	0.04 - 0.15
0.04 - 0.12	0.04 - 0.12	0.04 - 0.12	0.04 - 0.12	0.04 - 0.12	0.04 - 0.12
0.06 - 0.12	0.06 - 0.14	0.06 - 0.14	0.06 - 0.12	0.06 - 0.14	0.06 - 0.14
0.06 - 0.15	0.06 - 0.16	0.08 - 0.18	0.06 - 0.15	0.06 - 0.15	0.08 - 0.17
0.04 - 0.12	0.04 - 0.13	0.04 - 0.15	0.04 - 0.12	0.04 - 0.13	0.04 - 0.15
0.04 - 0.1	0.04 - 0.12	0.04 - 0.12	0.04 - 0.12	0.04 - 0.12	0.04 - 0.12
0.04 - 0.1	0.04 - 0.12	0.04 - 0.12	0.04 - 0.12	0.04 - 0.12	0.04 - 0.12
0.04 - 0.1	0.04 - 0.12	0.04 - 0.12	0.04 - 0.12	0.04 - 0.12	0.04 - 0.12
0.04 - 0.1	0.04 - 0.12	0.04 - 0.12	0.04 - 0.12	0.04 - 0.12	0.04 - 0.12
0.04 - 0.1	0.04 - 0.1	0.04 - 0.1	0.04 - 0.1	0.04 - 0.1	0.04 - 0.1
0.04 - 0.1	0.04 - 0.1	0.04 - 0.1	0.04 - 0.1	0.04 - 0.1	0.04 - 0.1
0.06 - 0.15	0.06 - 0.18	0.08 - 0.2	0.06 - 0.15	0.06 - 0.16	0.08 - 0.18
0.06 - 0.13	0.06 - 0.16	0.08 - 0.18	0.06 - 0.13	0.06 - 0.16	0.08 - 0.18
0.06 - 0.15	0.06 - 0.18	0.08 - 0.2	0.06 - 0.15	0.06 - 0.16	0.08 - 0.18
0.06 - 0.13	0.06 - 0.16	0.08 - 0.18	0.06 - 0.13	0.06 - 0.16	0.08 - 0.18
0.1 - 0.18	0.1 - 0.2	0.1 - 0.25	0.1 - 0.18	0.1 - 0.2	0.1 - 0.2
0.1 - 0.18	0.1 - 0.2	0.1 - 0.25	0.1 - 0.18	0.1 - 0.2	0.1 - 0.2
0.04 - 0.08	0.04 - 0.08	0.04 - 0.1	0.04 - 0.1	0.04 - 0.1	0.04 - 0.1
0.04 - 0.08	0.04 - 0.08	0.04 - 0.1	0.04 - 0.1	0.04 - 0.1	0.04 - 0.1
0.06 - 0.1	0.06 - 0.12	0.06 - 0.14	0.06 - 0.14	0.06 - 0.14	0.06 - 0.14
0.06 - 0.1	0.06 - 0.12	0.06 - 0.14	0.06 - 0.14	0.06 - 0.14	0.06 - 0.14
0.04 - 0.08	0.04 - 0.08	0.04 - 0.1	0.04 - 0.08	0.04 - 0.08	0.04 - 0.08
0.04 - 0.08	0.04 - 0.08	0.04 - 0.1	0.04 - 0.08	0.04 - 0.08	0.04 - 0.08

DS

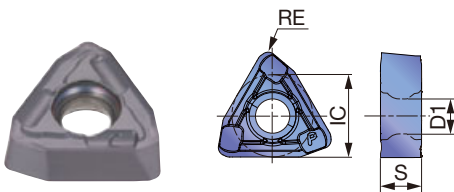

P	Steel	★							
M	Stainless	★							
K	Cast iron								
N	Non-ferrous	★							
S	Superalloys	★							
H	Hard materials								

★ : First choice
☆ : Second choice





Designation	IC	S	Coated						D1	RE	DCN	DCX
			AH6030									
WWMU05X205R-DS	5.8	2.4	●						2.5	0.5	20	23.5
WWMU060306R-DS	6.7	2.9	●						3	0.6	23.9	27
WWMU08X408R-DS	8	3.9	●						3.4	0.8	27.5	32
WWMU09X510R-DS	9.7	4.9	●						4.4	1	33	38
WWMU11X512R-DS	11.3	5.7	●						5.5	1.2	39	46
WWMU13X512R-DS	13	5.7	●						5.5	1.2	47	54

● : Line up

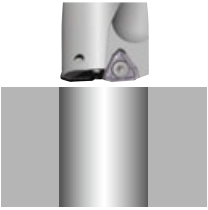
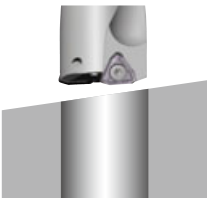
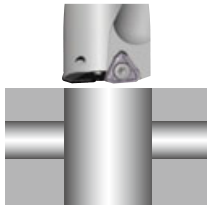

APPLICATION RANGE

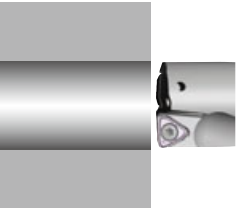
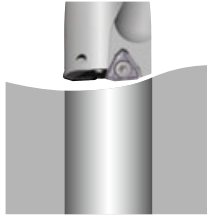
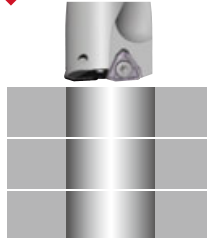
*In case of Interrupted cutting, feed should be decreased.

Feed f (mm/rev)	Refer to J064 - J065 page	0.05	0.05	0.05
Application range	OK Plane surface	OK Slant surface	OK Cross hole	OK Plunging
				
Feed f (mm/rev)	0.1	0.05	Disapprove	Disapprove
Application range	OK Boring	OK Round surface	X Stacked plates	X Back boring
				

TUNGSIX-DRILL

TDXCF chamfering tool

Chamfering tool for TungDrillTwisted and TungSix-Drill

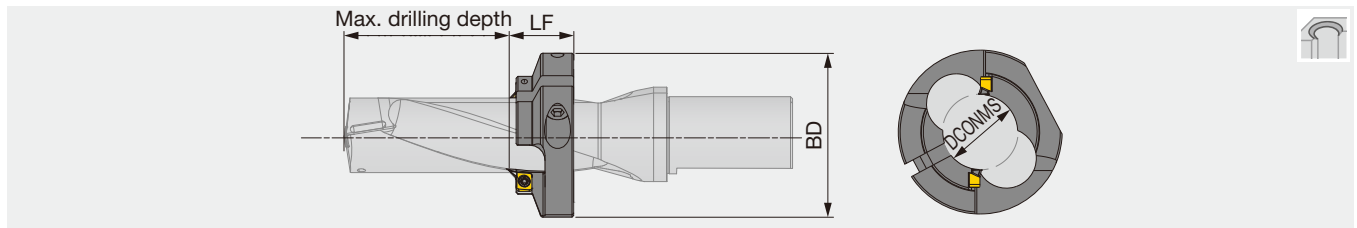

Designation	DCONMS	BD	LF	Application drill	Max. drilling depth		
					L/D = 2	L/D = 3	L/D = 4
TDXCF200L25	19.1	49	25	TDS200*25-*	15.5	35.5	62.5
TDXCF210L25	20.1	49	25	TDS205*25-*	16.5	37	64.6
TDXCF210L25	20.1	49	25	TDS209F25-3	-	38.5	-
TDXCF210L25	20.1	49	25	TDS210*25-*	17.5	38.5	66.5
TDXCF220L25	21.1	49	25	TDS215*25-*	18.5	40	68.6
TDXCF220L25	21.1	49	25	TDS220*25-*	19.5	41.5	70.5
TDXCF230L25	22.1	49	25	TDS225*25-*	20.5	43	72.6
TDXCF230L25	22.1	49	25	TDS230*25-*	21.5	44.5	74.5
TDXCF240L25	23.1	49	25	TDS235*25-*	22.5	46	76.6
TDXCF240L25	23.1	49	25	TDS239F25-3	-	47.5	-
TDXCF240L25	23.1	49	25	TDS240*25-*	23.5	47.5	78.5
TDXCF250L25	23.95	49	25	TDS245*25-*	24.5	49	80.6
TDXCF250L25	23.95	49	25	TDS250*25-*	25.5	50.5	82.5
TDXCF260L30	24.95	64	30	TDS255*25-*	21.5	47	79.6
TDXCF260L30	24.95	64	30	TDS260*25-*	22.5	48.5	81.5
TDXCF270L30	25.9	64	30	TDS264F32-3	-	50	-
TDXCF270L30	25.9	64	30	TDS265F32-3	-	50	-
TDXCF270L30	25.9	64	30	TDS270*32-*	24.5	51.5	85.5
TDXCF280L30	26.9	64	30	TDS280*32-*	26.5	54.5	89.5
TDXCF290L30	27.9	64	30	TDS290*32-*	28.5	57.5	93.5
TDXCF300L30	28.9	64	30	TDS300*32-*	30.5	60.5	97.5
TDXCF310L30	29.9	64	30	TDS310*32-*	32.5	63.5	101.5
TDXCF320L30	30.9	64	30	TDS320*32-*	34.5	66.5	105.5

SPARE PARTS

Designation	Screw for insert	Screw for ring	Wrench for insert	Wrench for ring
TDXCF200... - TDXCF250...	CSPB-4S	CM6X16	IP-15D	P-5
TDXCF260... - TDXCF320...	CSPB-4S	CM8X1.25X20-A	IP-15D	P-6

Recommended clamping torque (N·m): CSPB-4S = 3.5

INSERT

XHGX-45A

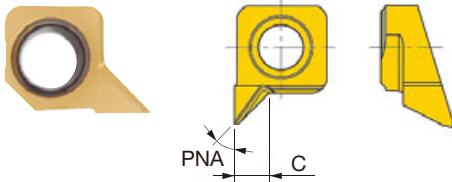

P	Steel	★								
M	Stainless	★								
K	Cast iron	★								
N	Non-ferrous	☆								
S	Superalloys	★								
H	Hard materials	★								
			Coated							
			GH130							
Designation	PNA	C								
XHGX090700R-45A	45°	2.5	●							

★ : First choice
☆ : Second choice

● : Line up

Caution in mounting the chamfering tool on the drill body

- ① Place the ring on the drill body and match the positions of flutes on drill and ring. Temporarily clamp the ring with the ring screw tightened lightly.
- ② Place the inserts, and tighten the insert screw lightly.
- ③ Adjust the ring position with a presetter, height gauge, or vernier caliper, and securely tighten the ring screw, then the insert screw.



Match the positions of flutes on drill and ring.
(Inserts will be automatically set to the right positions.)

The cutting edge of the insert is in the ring flute.



The flutes on drill and ring do not match.

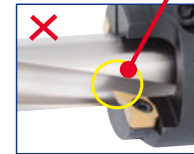

TUNGDRILL TWISTED

TDX-F L/D=2

Indexable drill, L/D = 2, flat cotter

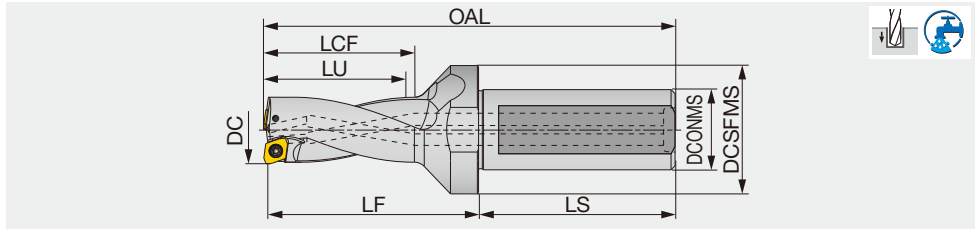

Designation	DC	DCONMS	DCSFMS	LU	LS	LCF	LF	OAL	Max. offset (radial)	WT(kg)	Insert
TDX125F20-2	12.5	20	25	25.4	49	28.4	41	90.4	0.8	0.2	XPMT040104R-D*
TDX130F20-2	13	20	25	26.4	49	29.4	42	91.4	0.7	0.2	XPMT040104R-D*
TDX135F20-2	13.5	20	25	27.4	49	30.4	43	92.4	0.6	0.2	XPMT040104R-D*
TDX140F20-2	14	20	25	28.4	49	31.4	44	93.4	0.5	0.2	XPMT040104R-D*
TDX145F20-2	14.5	20	25	29.4	49	32.4	46	95.4	0.4	0.2	XPMT040104R-D*
TDX150F20-2	15	20	25	30.5	49	33.5	47	96.5	0.9	0.2	XPMT050204R-D*
TDX155F20-2	15.5	20	32	31.5	49	34.5	49	98.5	0.8	0.2	XPMT050204R-D*
TDX160F20-2	16	20	32	32.5	49	35.5	51	100.5	0.6	0.2	XPMT050204R-D*
TDX165F20-2	16.5	20	32	33.5	49	36.5	52	101.5	0.5	0.2	XPMT050204R-D*
TDX170F20-2	17	20	32	34.5	49	37.5	53	102.5	0.4	0.2	XPMT050204R-D*
TDX175F25-2	17.5	25	32	35.5	54	38.5	55	109.5	1.2	0.3	XPMT06X308R-D*
TDX180F25-2	18	25	32	36.5	54	39.5	56	110.5	1.1	0.3	XPMT06X308R-D*
TDX185F25-2	18.5	25	32	37.5	54	40.5	57	111.5	0.9	0.3	XPMT06X308R-D*
TDX190F25-2	19	25	32	38.5	54	41.5	58	112.5	0.8	0.3	XPMT06X308R-D*
TDX195F25-2	19.5	25	32	39.5	54	42.5	60	114.5	0.7	0.3	XPMT06X308R-D*
TDX200F25-2	20	25	32	40.5	54	45.5	61	115.5	0.5	0.3	XPMT06X308R-D*
TDX205F25-2	20.5	25	32	41.5	54	46.5	62.5	117	0.4	0.3	XPMT06X308R-D*
TDX210F25-2	21	25	32	42.5	54	47.5	64	118.5	0.3	0.3	XPMT06X308R-D*
TDX215F25-2	21.5	25	32	43.5	54	48.5	65	119.5	0.2	0.3	XPMT06X308R-D*
TDX220F25-2	22	25	32	44.6	54	49.6	66	120.6	1.2	0.3	XPMT07H308R-D*
TDX225F25-2	22.5	25	37	45.6	54	50.6	67.5	122.1	1.1	0.3	XPMT07H308R-D*
TDX230F25-2	23	25	37	46.6	54	51.6	69	123.6	0.9	0.4	XPMT07H308R-D*
TDX235F25-2	23.5	25	37	47.6	54	52.6	70	124.6	0.8	0.4	XPMT07H308R-D*
TDX240F25-2	24	25	37	48.6	54	53.6	71	125.6	0.7	0.4	XPMT07H308R-D*
TDX245F25-2	24.5	25	37	49.6	54	54.6	72.5	127.1	0.5	0.4	XPMT07H308R-D*
TDX250F25-2	25	25	37	50.6	54	55.6	74	128.6	0.4	0.4	XPMT07H308R-D*
TDX255F25-2	25.5	25	37	51.6	54	56.6	75.5	130.1	0.3	0.4	XPMT07H308R-D*
TDX260F25-2	26	25	37	52.6	54	57.6	77	131.6	0.2	0.4	XPMT07H308R-D*
TDX270F32-2	27	32	40	54.7	59	59.7	79	138.7	1.5	0.6	XPMT08T308R-D*
TDX280F32-2	28	32	40	56.7	59	61	82.3	142	1.2	0.6	XPMT08T308R-D*
TDX290F32-2	29	32	40	58.7	59	63	84.3	144	1	0.7	XPMT08T308R-D*
TDX300F32-2	30	32	40	60.7	59	65	87.3	147	0.7	0.7	XPMT08T308R-D*
TDX310F32-2	31	32	40	62.7	59	67	90.3	150	0.4	0.7	XPMT08T308R-D*
TDX320F32-2	32	32	40	64.7	59	69	92.3	152	0.2	0.8	XPMT08T308R-D*
TDX330F40-2	33	40	50	67.1	69	71.7	95.6	165.7	2.3	1.2	XPMT110412R-D*
TDX340F40-2	34	40	50	69.1	69	73.7	98.6	168.7	2.1	1.2	XPMT110412R-D*
TDX350F40-2	35	40	50	71.1	69	75.7	101.6	171.7	1.8	1.2	XPMT110412R-D*
TDX360F40-2	36	40	50	73.1	69	77.7	104.6	174.7	1.5	1.3	XPMT110412R-D*
TDX370F40-2	37	40	50	75.1	69	79.7	105.6	175.7	1.3	1.3	XPMT110412R-D*
TDX380F40-2	38	40	50	77.1	69	81.7	108.6	178.7	1	1.3	XPMT110412R-D*
TDX390F40-2	39	40	50	79.1	69	83.7	110.6	180.7	0.7	1.4	XPMT110412R-D*
TDX400F40-2	40	40	50	81.1	69	85.7	113.6	183.7	0.5	1.4	XPMT110412R-D*
TDX410F40-2	41	40	50	83.1	69	87.7	117.6	187.7	0.2	1.5	XPMT110412R-D*
TDX420F40-2	42	40	55	85.6	69	90.6	120	190.6	3.1	1.6	XPMT150512R-D*
TDX430F40-2	43	40	55	87.6	69	92.6	123	193.6	2.9	1.6	XPMT150512R-D*
TDX440F40-2	44	40	55	89.6	69	94.6	125	195.6	2.6	1.7	XPMT150512R-D*
TDX450F40-2	45	40	55	91.6	69	96.6	128	198.6	2.3	1.7	XPMT150512R-D*
TDX460F40-2	46	40	55	93.6	69	98.6	131	201.6	2.1	1.8	XPMT150512R-D*
TDX470F40-2	47	40	55	95.6	69	100.6	133	203.6	1.8	1.9	XPMT150512R-D*
TDX480F40-2	48	40	55	97.6	69	102.6	136	206.6	1.5	1.9	XPMT150512R-D*
TDX490F40-2	49	40	55	99.6	69	104.6	138	208.6	1.3	1.9	XPMT150512R-D*
TDX500F40-2	50	40	55	101.6	69	106.6	141	211.6	1	2	XPMT150512R-D*

Designation	DC	DCONMS	DCSFMS	LU	LS	LCF	LF	OAL	Max. offset (radial)	WT(kg)	Insert
TDX510F40-2	51	40	55	103.6	69	108.6	145	215.6	0.7	2.1	XPMT150512R-D*
TDX520F40-2	52	40	55	105.6	69	110.6	147	217.6	0.5	2.2	XPMT150512R-D*
TDX530F40-2	53	40	55	107.6	69	112.6	150	220.6	-	2.3	XPMT150512R-D*
TDX540F40-2	54	40	55	109.6	69	114.6	152	222.6	-	2.4	XPMT150512R-D*

Tool diameter	Tool diameter tolerance	Hole diameter tolerance*
ø12.5 - ø17	+ 0.1 / 0	+ 0.25 / 0
ø17.5 - ø54	+ 0.2 / 0	+ 0.3 / 0

*Just for reference

SPARE PARTS



Designation	Clamping screw	Wrench
TDX125 - 145	CSPB-2H	IP-6DB
TDX150 - 170	CSPB-2L043	IP-6DB
TDX175 - 215	CSPB-2.2	IP-7D
TDX220 - 260	CSPB-2.5	IP-8D
TDX270 - 320	CSTB-3	T-9D
TDX330 - 410	CSTB-4	T-15D
TDX420 - 540	CSTB-5	T-20D

Recommended clamping torque (N·m): CSPB-2H/CSPB-2L043=0.7, CSPB-2.2=1, CSPB-2.5=1.3, CSTB-3=2.3, CSTB-4=3.5, CSTB-5=5

Grade
Insert
Ext. Toolholder
Int. Toolholder
Threading
Grooving
Miniature tool
Milling cutter
Endmill
Drilling tool
Tooling System
User's Guide
Index



Reference pages: Inserts → **J076 - J077**
Standard cutting conditions → **J078**

TUNGDRILL TWISTED

TDX-F L/D=3

Indexable drill, L/D = 3, flat cotter

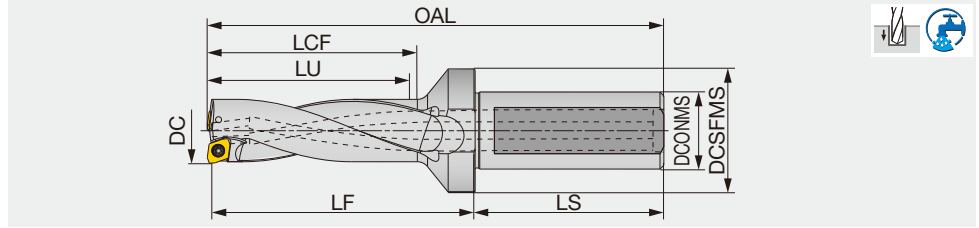

Designation	DC	DCONMS	DCSFMS	LU	LS	LCF	LF	OAL	Max. offset (radial)	WT(kg)	Insert
TDX125F20-3	12.5	20	25	37.9	49	40.9	53	102.4	0.8	0.2	XPMT040104R-D*
TDX130F20-3	13	20	25	39.4	49	42.4	55	104.4	0.7	0.2	XPMT040104R-D*
TDX135F20-3	13.5	20	25	40.9	49	43.9	56	105.4	0.6	0.2	XPMT040104R-D*
TDX140F20-3	14	20	25	42.4	49	45.4	58	107.4	0.5	0.2	XPMT040104R-D*
TDX145F20-3	14.5	20	25	43.9	49	46.9	60	109.4	0.4	0.2	XPMT040104R-D*
TDX150F20-3	15	20	25	45.4	49	48.4	62	111.4	0.9	0.2	XPMT050204R-D*
TDX155F20-3	15.5	20	32	46.9	49	49.9	64	113.4	0.8	0.2	XPMT050204R-D*
TDX160F20-3	16	20	32	48.4	49	51.4	66	115.4	0.6	0.2	XPMT050204R-D*
TDX165F20-3	16.5	20	32	49.9	49	52.9	68	117.4	0.5	0.2	XPMT050204R-D*
TDX170F20-3	17	20	32	51.4	49	54.4	69	118.4	0.4	0.2	XPMT050204R-D*
TDX175F25-3	17.5	25	32	53	54	56	72	126.5	1.2	0.3	XPMT06X308R-D*
TDX180F25-3	18	25	32	54.5	54	57.5	73	127.5	1.1	0.3	XPMT06X308R-D*
TDX185F25-3	18.5	25	32	56	54	59	75	129.5	0.9	0.3	XPMT06X308R-D*
TDX190F25-3	19	25	32	57.5	54	60.5	76	130.5	0.8	0.3	XPMT06X308R-D*
TDX195F25-3	19.5	25	32	59	54	62	79	133.5	0.7	0.3	XPMT06X308R-D*
TDX200F25-3	20	25	32	60.5	54	65.5	81	135.5	0.5	0.3	XPMT06X308R-D*
TDX205F25-3	20.5	25	32	62	54	67	82	136.5	0.4	0.3	XPMT06X308R-D*
TDX210F25-3	21	25	32	63.5	54	68.5	84	138.5	0.3	0.3	XPMT06X308R-D*
TDX215F25-3	21.5	25	32	65	54	70	86	140.5	0.2	0.4	XPMT06X308R-D*
TDX220F25-3	22	25	32	66.6	54	71.6	87	141.6	1.2	0.4	XPMT07H308R-D*
TDX225F25-3	22.5	25	37	68.1	54	73.1	90	144.6	1.1	0.4	XPMT07H308R-D*
TDX230F25-3	23	25	37	69.6	54	74.6	91	145.6	0.9	0.4	XPMT07H308R-D*
TDX235F25-3	23.5	25	37	71.1	54	76.1	93	147.6	0.8	0.4	XPMT07H308R-D*
TDX240F25-3	24	25	37	72.6	54	77.6	95	149.6	0.7	0.4	XPMT07H308R-D*
TDX245F25-3	24.5	25	37	74.1	54	79.1	97	151.6	0.5	0.5	XPMT07H308R-D*
TDX250F25-3	25	25	37	75.6	54	80.6	99	153.6	0.4	0.5	XPMT07H308R-D*
TDX255F25-3	25.5	25	37	77.1	54	82.1	100	154.6	0.3	0.5	XPMT07H308R-D*
TDX260F25-3	26	25	37	78.6	54	83.6	102	156.6	0.2	0.5	XPMT07H308R-D*
TDX270F32-3	27	32	40	81.7	59	86.7	105	164.7	1.5	0.6	XPMT08T308R-D*
TDX280F32-3	28	32	40	84.7	59	89	109.3	169	1.2	0.7	XPMT08T308R-D*
TDX290F32-3	29	32	40	87.7	59	92	112.3	172	1	0.7	XPMT08T308R-D*
TDX300F32-3	30	32	40	90.7	59	95	117.3	177	0.7	0.8	XPMT08T308R-D*
TDX310F32-3	31	32	40	93.7	59	98	121.3	181	0.4	0.8	XPMT08T308R-D*
TDX320F32-3	32	32	40	96.7	59	101	124.3	184	0.2	0.9	XPMT08T308R-D*
TDX330F40-3	33	40	50	100.1	69	104.7	128.6	198.7	2.3	1.3	XPMT110412R-D*
TDX340F40-3	34	40	50	103.1	69	107.7	131.6	201.7	2.1	1.3	XPMT110412R-D*
TDX350F40-3	35	40	50	106.1	69	110.7	135.6	205.7	1.8	1.3	XPMT110412R-D*
TDX360F40-3	36	40	50	109.1	69	113.7	139.6	209.7	1.5	1.4	XPMT110412R-D*
TDX370F40-3	37	40	50	112.1	69	116.7	142.6	212.7	1.3	1.4	XPMT110412R-D*
TDX380F40-3	38	40	50	115.1	69	119.7	146.6	216.7	1	1.5	XPMT110412R-D*
TDX390F40-3	39	40	50	118.1	69	122.7	149.6	219.7	0.7	1.6	XPMT110412R-D*
TDX400F40-3	40	40	50	121.1	69	125.7	153.6	223.7	0.5	1.6	XPMT110412R-D*
TDX410F40-3	41	40	50	124.1	69	128.7	157.6	227.7	0.2	1.7	XPMT110412R-D*
TDX420F40-3	42	40	55	127.6	69	132.6	161	231.6	3.1	1.8	XPMT150512R-D*
TDX430F40-3	43	40	55	130.6	69	135.6	165	235.6	2.9	1.8	XPMT150512R-D*
TDX440F40-3	44	40	55	133.6	69	138.6	168	238.6	2.6	1.9	XPMT150512R-D*
TDX450F40-3	45	40	55	136.6	69	141.6	173	243.6	2.3	2	XPMT150512R-D*
TDX460F40-3	46	40	55	139.6	69	144.6	177	247.6	2.1	2.1	XPMT150512R-D*
TDX470F40-3	47	40	55	142.6	69	147.6	180	250.6	1.8	2.2	XPMT150512R-D*
TDX480F40-3	48	40	55	145.6	69	150.6	184	254.6	1.5	2.3	XPMT150512R-D*
TDX490F40-3	49	40	55	148.6	69	153.6	187	257.6	1.3	2.3	XPMT150512R-D*

Designation	DC	DCONMS	DCSFMS	LU	LS	LCF	LF	OAL	Max. offset (radial)	WT(kg)	Insert
TDX500F40-3	50	40	55	151.6	69	156.6	191	261.6	1	2.4	XPMT150512R-D*
TDX510F40-3	51	40	55	154.6	69	159.6	195	265.6	0.7	2.5	XPMT150512R-D*
TDX520F40-3	52	40	55	157.6	69	162.6	198	268.6	0.5	2.6	XPMT150512R-D*
TDX530F40-3	53	40	55	160.6	69	165.6	202	272.6	-	2.7	XPMT150512R-D*
TDX540F40-3	54	40	55	163.6	69	168.6	205	275.6	-	2.9	XPMT150512R-D*

Tool diameter	Tool diameter tolerance	Hole diameter tolerance*
ø12.5 - ø17	+ 0.1 / 0	+ 0.25 / 0
ø17.5 - ø54	+ 0.2 / 0	+ 0.3 / 0

*Just for reference

SPARE PARTS



Designation	Clamping screw	Wrench
TDX125 - 145	CSPB-2H	IP-6DB
TDX150 - 170	CSPB-2L043	IP-6DB
TDX175 - 215	CSPB-2.2	IP-7D
TDX220 - 260	CSPB-2.5	IP-8D
TDX270 - 320	CSTB-3	T-9D
TDX330 - 410	CSTB-4	T-15D
TDX420 - 540	CSTB-5	T-20D

Recommended clamping torque (N·m): CSPB-2H/CSPB-2L043=0.7, CSPB-2.2=1, CSPB-2.5=1.3, CSTB-3=2.3, CSTB-4=3.5, CSTB-5=5

Grade
Insert
Ext. Toolholder
Int. Toolholder
Threading
Grooving
Miniature tool
Milling cutter
Endmill
Drilling tool
Tooling System
User's Guide
Index



Reference pages: Inserts → **J076 - J077**
Standard cutting conditions → **J078**

TUNGDRILL TWISTED

TDX-F L/D=4

Indexable drill, L/D = 4, flat cotter

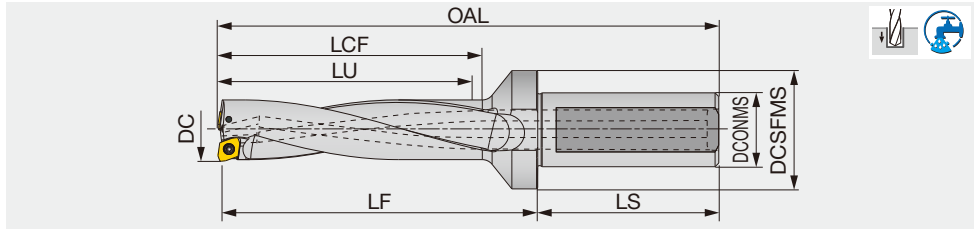

Designation	DC	DCONMS	DCSFMS	LU	LS	LCF	LF	OAL	Max. offset (radial)	WT(kg)	Insert
TDX125F20-4	12.5	20	25	50.4	49	53.4	66	115.4	0.8	0.2	XPMT040104R-D*
TDX130F20-4	13	20	25	52.4	49	55.4	68	117.4	0.7	0.2	XPMT040104R-D*
TDX135F20-4	13.5	20	25	54.4	49	57.4	70	119.4	0.6	0.2	XPMT040104R-D*
TDX140F20-4	14	20	25	56.4	49	59.4	72	121.4	0.5	0.2	XPMT040104R-D*
TDX145F20-4	14.5	20	25	58.4	49	61.4	75	124.4	0.4	0.2	XPMT040104R-D*
TDX150F20-4	15	20	25	60.4	49	63.4	77	126.4	0.9	0.2	XPMT050204R-D*
TDX155F20-4	15.5	20	32	62.4	49	65.4	79	128.4	0.8	0.2	XPMT050204R-D*
TDX160F20-4	16	20	32	64.4	49	67.4	82	131.4	0.6	0.2	XPMT050204R-D*
TDX165F20-4	16.5	20	32	66.4	49	69.4	84	133.4	0.5	0.2	XPMT050204R-D*
TDX170F20-4	17	20	32	68.4	49	71.4	86	135.4	0.4	0.2	XPMT050204R-D*
TDX175F25-4	17.5	25	32	70.5	54	73.5	89	143.5	1.2	0.3	XPMT06X308R-D*
TDX180F25-4	18	25	32	72.5	54	75.5	91	145.5	1.1	0.3	XPMT06X308R-D*
TDX185F25-4	18.5	25	32	74.5	54	77.5	93	147.5	0.9	0.3	XPMT06X308R-D*
TDX190F25-4	19	25	32	76.5	54	79.5	95	149.5	0.8	0.3	XPMT06X308R-D*
TDX195F25-4	19.5	25	32	78.5	54	81.5	99	153.5	0.7	0.4	XPMT06X308R-D*
TDX200F25-4	20	25	32	80.5	54	84.5	101	155.5	0.5	0.4	XPMT06X308R-D*
TDX205F25-4	20.5	25	32	82.5	54	86.5	103	157.5	0.4	0.4	XPMT06X308R-D*
TDX210F25-4	21	25	32	84.5	54	88.5	105	159.5	0.3	0.4	XPMT06X308R-D*
TDX215F25-4	21.5	25	32	86.5	54	90.5	107	161.5	0.2	0.4	XPMT06X308R-D*
TDX220F25-4	22	25	32	88.6	54	92.6	109	163.6	1.2	0.5	XPMT07H308R-D*
TDX225F25-4	22.5	25	37	90.6	54	94.6	111.5	166.1	1.1	0.5	XPMT07H308R-D*
TDX230F25-4	23	25	37	92.6	54	96.6	114	168.6	0.9	0.4	XPMT07H308R-D*
TDX235F25-4	23.5	25	37	94.6	54	98.6	116.5	171.1	0.8	0.4	XPMT07H308R-D*
TDX240F25-4	24	25	37	96.6	54	100.6	119	173.6	0.7	0.4	XPMT07H308R-D*
TDX245F25-4	24.5	25	37	98.6	54	102.6	121.5	176.1	0.5	0.6	XPMT07H308R-D*
TDX250F25-4	25	25	37	100.6	54	104.6	124	178.6	0.4	0.6	XPMT07H308R-D*
TDX255F25-4	25.5	25	37	102.6	54	106.6	126	180.6	0.3	0.6	XPMT07H308R-D*
TDX260F25-4	26	25	37	104.6	54	108.6	128	182.6	0.2	0.6	XPMT07H308R-D*
TDX270F32-4	27	32	40	108.7	59	112.7	132	191.7	1.5	0.6	XPMT08T308R-D*
TDX280F32-4	28	32	40	112.7	59	116.7	137	196.7	1.2	0.8	XPMT08T308R-D*
TDX290F32-4	29	32	40	116.7	59	120.7	141	200.7	1	0.7	XPMT08T308R-D*
TDX300F32-4	30	32	40	120.7	59	124.7	147	206.7	0.7	0.9	XPMT08T308R-D*
TDX310F32-4	31	32	40	124.7	59	128.7	152	211.7	0.4	0.9	XPMT08T308R-D*
TDX320F32-4	32	32	40	128.7	59	132.7	156	215.7	0.2	1	XPMT08T308R-D*
TDX330F40-4	33	40	50	133.1	69	137.1	161	231.1	2.3	1.4	XPMT110412R-D*
TDX340F40-4	34	40	50	137.1	69	141.1	165	235.1	2.1	1.4	XPMT110412R-D*
TDX350F40-4	35	40	50	141.1	69	145.1	170	240.1	1.8	1.4	XPMT110412R-D*
TDX360F40-4	36	40	50	145.1	69	149.1	175	245.1	1.5	1.5	XPMT110412R-D*
TDX370F40-4	37	40	50	149.1	69	153.1	179	249.1	1.3	1.5	XPMT110412R-D*
TDX380F40-4	38	40	50	153.1	69	157.1	184	254.1	1	1.7	XPMT110412R-D*
TDX390F40-4	39	40	50	157.1	69	161.1	188	258.1	0.7	1.8	XPMT110412R-D*
TDX400F40-4	40	40	50	161.1	69	165.1	193	263.1	0.5	1.8	XPMT110412R-D*
TDX410F40-4	41	40	50	165.1	69	169.1	198	268.1	0.2	1.9	XPMT110412R-D*
TDX420F40-4	42	40	55	169.6	69	173.6	202	272.6	3.1	2	XPMT150512R-D*
TDX430F40-4	43	40	55	173.6	69	177.6	207	277.6	2.9	2	XPMT150512R-D*
TDX440F40-4	44	40	55	177.6	69	181.6	211	281.6	2.6	2.1	XPMT150512R-D*
TDX450F40-4	45	40	55	181.6	69	185.6	217	287.6	2.3	2.3	XPMT150512R-D*
TDX460F40-4	46	40	55	185.6	69	189.6	222	292.6	2.1	2.4	XPMT150512R-D*
TDX470F40-4	47	40	55	189.6	69	193.6	226	296.6	1.8	2.5	XPMT150512R-D*
TDX480F40-4	48	40	55	193.6	69	197.6	231	301.6	1.5	2.7	XPMT150512R-D*
TDX490F40-4	49	40	55	197.6	69	201.6	235	305.6	1.3	2.7	XPMT150512R-D*
TDX500F40-4	50	40	55	201.6	69	205.6	240	310.6	1	2.8	XPMT150512R-D*

Designation	DC	DCONMS	DCSFMS	LU	LS	LCF	LF	OAL	Max. offset (radial)	WT(kg)	Insert
TDX510F40-4	51	40	55	205.6	69	209.6	245	315.6	0.7	2.9	XPMT150512R-D*
TDX520F40-4	52	40	55	209.6	69	213.6	249	319.6	0.5	3	XPMT150512R-D*
TDX530F40-4	53	40	55	213.6	69	217.6	254	324.6	-	3.1	XPMT150512R-D*
TDX540F40-4	54	40	55	217.6	69	221.6	258	328.6	-	3.4	XPMT150512R-D*

Tool diameter	Tool diameter tolerance	Hole diameter tolerance*
ø12.5 - ø17	+ 0.1 / 0	+ 0.4 / 0
ø17.5 - ø54	+ 0.2 / 0	+ 0.45 / 0

*Just for reference

SPARE PARTS



Designation	Clamping screw	Wrench
TDX125 - 145	CSPB-2H	IP-6DB
TDX150 - 170	CSPB-2L043	IP-6DB
TDX175 - 215	CSPB-2.2	IP-7D
TDX220 - 260	CSPB-2.5	IP-8D
TDX270 - 320	CSTB-3	T-9D
TDX330 - 410	CSTB-4	T-15D
TDX420 - 540	CSTB-5	T-20D

Recommended clamping torque (N·m): CSPB-2H/CSPB-2L043=0.7, CSPB-2.2=1, CSPB-2.5=1.3, CSTB-3=2.3, CSTB-4=3.5, CSTB-5=5

Grade
Insert
Ext. Toolholder
Int. Toolholder
Threading
Grooving
Miniature tool
Milling cutter
Endmill
Drilling tool
Tooling System
User's Guide
Index



Reference pages: Inserts → **J076 - J077**
Standard cutting conditions → **J078**

TUNGDRILL TWISTED

TDX-F L/D=5

Indexable drill, L/D = 5, flat cotter

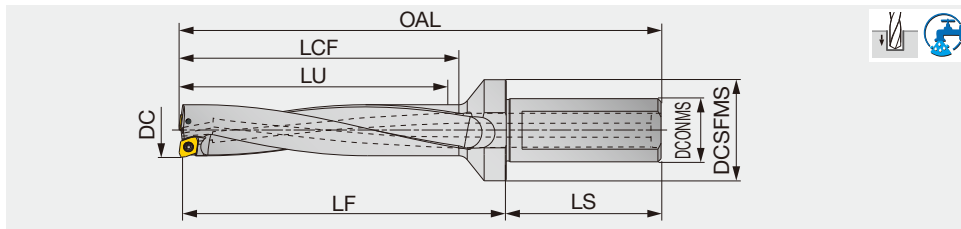

Designation	DC	DCONMS	DCSFMS	LU	LS	LCF	LF	OAL	Max. offset (radial)	WT(kg)	Insert
TDX125F20-5	12.5	20	25	62.9	49	65.9	78.5	127.9	0.8	0.2	XPMT040104R-D*
TDX130F20-5	13	20	25	65.4	49	68.4	81	130.4	0.7	0.2	XPMT040104R-D*
TDX135F20-5	13.5	20	25	67.9	49	70.9	83.5	132.9	0.6	0.2	XPMT040104R-D*
TDX140F20-5	14	20	25	70.4	49	73.4	86	135.4	0.5	0.2	XPMT040104R-D*
TDX145F20-5	14.5	20	25	72.9	49	75.9	89.5	138.9	0.4	0.2	XPMT040104R-D*
TDX150F20-5	15	20	25	75.4	49	78.4	92	141.4	0.9	0.2	XPMT050204R-D*
TDX155F20-5	15.5	20	32	77.9	49	80.9	94.5	143.9	0.8	0.2	XPMT050204R-D*
TDX160F20-5	16	20	32	80.4	49	83.4	98	147.4	0.6	0.2	XPMT050204R-D*
TDX165F20-5	16.5	20	32	82.9	49	85.9	100.5	149.9	0.5	0.2	XPMT050204R-D*
TDX170F20-5	17	20	32	85.4	49	88.4	103	152.4	0.4	0.2	XPMT050204R-D*
TDX175F25-5	17.5	25	32	88	54	91	106.5	161	1.2	0.3	XPMT06X308R-D*
TDX180F25-5	18	25	32	90.5	54	93.5	109	163.5	1.1	0.3	XPMT06X308R-D*
TDX185F25-5	18.5	25	32	93	54	96	111.5	166	0.9	0.4	XPMT06X308R-D*
TDX190F25-5	19	25	32	95.5	54	98.5	114	168.5	0.8	0.4	XPMT06X308R-D*
TDX195F25-5	19.5	25	32	98	54	101	118.5	173	0.7	0.4	XPMT06X308R-D*
TDX200F25-5	20	25	32	100.5	54	104.5	121	175.5	0.5	0.4	XPMT06X308R-D*
TDX205F25-5	20.5	25	32	103	54	107	123.5	178	0.4	0.4	XPMT06X308R-D*
TDX210F25-5	21	25	32	105.5	54	109.5	126	180.5	0.3	0.4	XPMT06X308R-D*
TDX215F25-5	21.5	25	32	108	54	112	128.5	183	0.2	0.4	XPMT06X308R-D*
TDX220F25-5	22	25	32	110.6	54	114.6	131	185.6	1.2	0.6	XPMT07H308R-D*
TDX225F25-5	22.5	25	37	113.1	54	117.1	134	188.6	1.1	0.6	XPMT07H308R-D*
TDX230F25-5	23	25	37	115.6	54	119.6	137	191.6	0.9	0.4	XPMT07H308R-D*
TDX235F25-5	23.5	25	37	118.1	54	122.1	140	194.6	0.8	0.4	XPMT07H308R-D*
TDX240F25-5	24	25	37	120.6	54	124.6	143	197.6	0.7	0.4	XPMT07H308R-D*
TDX245F25-5	24.5	25	37	123.1	54	127.1	146	200.6	0.5	0.7	XPMT07H308R-D*
TDX250F25-5	25	25	37	125.6	54	129.6	149	203.6	0.4	0.7	XPMT07H308R-D*
TDX255F25-5	25.5	25	37	128.1	54	132.1	151.5	206.1	0.3	0.7	XPMT07H308R-D*
TDX260F25-5	26	25	37	130.6	54	134.6	154	208.6	0.2	0.7	XPMT07H308R-D*
TDX270F32-5	27	32	40	135.7	59	139.7	159	218.7	1.5	0.6	XPMT08T308R-D*
TDX280F32-5	28	32	40	140.7	59	144.7	165	224.7	1.2	0.9	XPMT08T308R-D*
TDX290F32-5	29	32	40	145.7	59	149.7	170	229.7	1	0.7	XPMT08T308R-D*
TDX300F32-5	30	32	40	150.7	59	154.7	177	236.7	0.7	1	XPMT08T308R-D*
TDX310F32-5	31	32	40	155.7	59	159.7	183	242.7	0.4	1	XPMT08T308R-D*
TDX320F32-5	32	32	40	160.7	59	164.7	188	247.7	0.2	1.1	XPMT08T308R-D*
TDX330F40-5	33	40	50	166.1	69	170.1	194	264.1	2.3	1.5	XPMT110412R-D*
TDX340F40-5	34	40	50	171.1	69	175.1	199	269.1	2.1	1.5	XPMT110412R-D*
TDX350F40-5	35	40	50	176.1	69	180.1	205	275.1	1.8	1.5	XPMT110412R-D*
TDX360F40-5	36	40	50	181.1	69	185.1	211	281.1	1.5	1.6	XPMT110412R-D*
TDX370F40-5	37	40	50	186.1	69	190.1	216	286.1	1.3	1.6	XPMT110412R-D*
TDX380F40-5	38	40	50	191.1	69	195.1	222	292.1	1	1.9	XPMT110412R-D*
TDX390F40-5	39	40	50	196.1	69	200.1	227	297.1	0.7	2	XPMT110412R-D*
TDX400F40-5	40	40	50	201.1	69	205.1	233	303.1	0.5	2	XPMT110412R-D*
TDX410F40-5	41	40	50	206.1	69	210.1	239	309.1	0.2	2.1	XPMT110412R-D*
TDX420F40-5	42	40	55	211.6	69	215.6	244	314.6	3.1	2.2	XPMT150512R-D*
TDX430F40-5	43	40	55	216.6	69	220.6	250	320.6	2.9	2.2	XPMT150512R-D*
TDX440F40-5	44	40	55	221.6	69	225.6	255	325.6	2.6	2.3	XPMT150512R-D*
TDX450F40-5	45	40	55	226.6	69	230.6	262	332.6	2.3	2.6	XPMT150512R-D*
TDX460F40-5	46	40	55	231.6	69	235.6	268	338.6	2.1	2.7	XPMT150512R-D*
TDX470F40-5	47	40	55	236.6	69	240.6	273	343.6	1.8	2.8	XPMT150512R-D*
TDX480F40-5	48	40	55	241.6	69	245.6	279	349.6	1.5	3.1	XPMT150512R-D*
TDX490F40-5	49	40	55	246.6	69	250.6	284	354.6	1.3	3.1	XPMT150512R-D*
TDX500F40-5	50	40	55	251.6	69	255.6	290	360.6	1	3.2	XPMT150512R-D*

Designation	DC	DCONMS	DCSFMS	LU	LS	LCF	LF	OAL	Max. offset (radial)	WT(kg)	Insert
TDX510F40-5	51	40	55	256.6	69	260.6	296	366.6	0.7	3.3	XPMT150512R-D*
TDX520F40-5	52	40	55	261.6	69	265.6	301	371.6	0.5	3.4	XPMT150512R-D*
TDX530F40-5	53	40	55	266.6	69	270.6	307	377.6	-	3.5	XPMT150512R-D*
TDX540F40-5	54	40	55	271.6	69	275.6	312	382.6	-	3.9	XPMT150512R-D*

Tool diameter	Tool diameter tolerance	Hole diameter tolerance*
ø12.5 - ø17	+ 0.1 / 0	+ 0.4 / 0
ø17.5 - ø54	+ 0.2 / 0	+ 0.45 / 0

*Just for reference

SPARE PARTS



Designation	Clamping screw	Wrench
TDX125 - 145	CSPB-2H	IP-6DB
TDX150 - 170	CSPB-2L043	IP-6DB
TDX175 - 215	CSPB-2.2	IP-7D
TDX220 - 260	CSPB-2.5	IP-8D
TDX270 - 320	CSTB-3	T-9D
TDX330 - 410	CSTB-4	T-15D
TDX420 - 540	CSTB-5	T-20D

Recommended clamping torque (N·m): CSPB-2H/CSPB-2L043=0.7, CSPB-2.2=1, CSPB-2.5=1.3, CSTB-3=2.3, CSTB-4=3.5, CSTB-5=5

Grade
Insert
Ext. Toolholder
Int. Toolholder
Threading
Grooving
Miniature tool
Milling cutter
Endmill
Drilling tool
Tooling System
User's Guide
Index



Reference pages: Inserts → **J076 - J077**
Standard cutting conditions → **J078**

INSERT

DJ

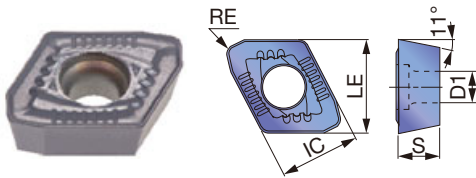

P	Steel			★	☆				
M	Stainless	☆		★					
K	Cast iron		☆	☆	★				
N	Non-ferrous	★		☆					
S	Superalloys	☆		★	☆				
H	Hard materials	☆		★	☆				

★ : First choice
☆ : Second choice

Designation	IC	LE	Coated				S	D1	RE	DCN	DCX
			AH725	T1115	AH6030	AH9030					
XPMT040104R-DJ	4.3	4.5	●	●	●	●	1.59	2.3	0.4	12.5	14.5
XPMT050204R-DJ	5.2	5.4	●	●	●	●	2.38	2.3	0.4	15	17
XPMT06X308R-DJ	6	7	●	●	●	●	3	2.5	0.8	17.5	21.5
XPMT07H308R-DJ	7	8.2	●	●	●	●	3.6	2.8	0.8	22	26
XPMT08T308R-DJ	8.5	9.9	●	●	●	●	3.97	3.4	0.8	27	32
XPMT110412R-DJ	11.2	12.5	●	●	●	●	4.76	4.4	1.2	33	41
XPMT150512R-DJ	15	16.1	●	●	●	●	5.56	5.5	1.2	42	54

● : Line up

DS

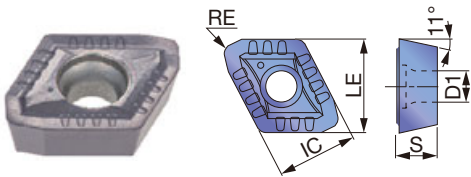

P	Steel	☆	★						
M	Stainless	☆	★						
K	Cast iron								
N	Non-ferrous	☆							
S	Superalloys	☆	★						
H	Hard materials								

★ : First choice
☆ : Second choice

Designation	IC	LE	Coated		S	D1	RE	DCN	DCX
			AH725	AH6030					
XPMT040104R-DS	4.3	4.5	●	●	1.59	2.3	0.4	12.5	14.5
XPMT050204R-DS	5.2	5.4	●	●	2.38	2.3	0.4	15	17
XPMT06X308R-DS	6	7	●	●	3	2.5	0.8	17.5	21.5
XPMT07H308R-DS	7	8.2	●	●	3.6	2.8	0.8	22	26
XPMT08T308R-DS	8.5	9.9	●	●	3.97	3.4	0.8	27	32
XPMT110412R-DS	11.2	12.5	●	●	4.76	4.4	1.2	33	41
XPMT150512R-DS	15	16.1	●	●	5.56	5.5	1.2	42	54

● : Line up

DW

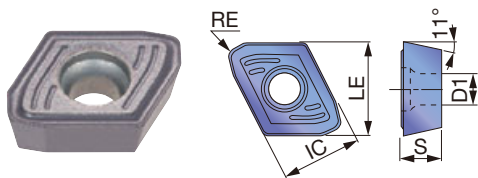

P	Steel	☆	★	☆									
M	Stainless	☆	★	☆									
K	Cast iron		☆	★									
N	Non-ferrous	☆	★										
S	Superalloys	☆	★	☆									
H	Hard materials	☆	★	☆									

★ : First choice
☆ : Second choice

Designation	IC	LE	Coated										S	D1	RE	DCN	DCX	
			AH725	AH6030	AH9030													
XPMT040104R-DW	4.3	4.5	●	●	●									1.59	2.3	0.4	12.5	14.5
XPMT050204R-DW	5.2	5.4	●	●	●									2.38	2.3	0.4	15	17
XPMT06X308R-DW	6	7	●	●	●									3	2.5	0.8	17.5	21.5
XPMT07H308R-DW	7	8.2	●	●	●									3.6	2.8	0.8	22	26
XPMT08T308R-DW	8.5	9.9	●	●	●									3.97	3.4	0.8	27	32
XPMT110412R-DW	11.2	12.5	●	●	●									4.76	4.4	1.2	33	41
XPMT150512R-DW	15	16.1	●	●	●									5.56	5.5	1.2	42	54

● : Line up

DG

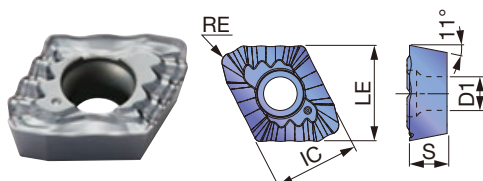

P	Steel	★																
M	Stainless	☆																
K	Cast iron																	
N	Non-ferrous	★																
S	Superalloys	☆																
H	Hard materials																	

★ : First choice
☆ : Second choice

Designation	IC	LE	Coated										S	D1	RE	DCN	DCX	
			AH725															
XPMT08T308R-DG	8.5	9.9	●											3.97	3.4	0.8	27	32
XPMT110412R-DG	11.2	12.5	●											4.76	4.4	1.2	33	41
XPMT150512R-DG	15	16.1	●											5.56	5.5	1.2	42	54

● : Line up





RECOMMENDED INSERT

ISO	Workpiece material	Hardness	First choice	High feed	High speed	Troubleshooting			
						Chipping resistance	Wear resistance	Surface finish	Chip control
P	Low carbon steels (C ≤ 0.3%)	- 200 HB	DS, AH6030	-	-	DS, AH725	-	DW, AH6030	DG, AH725
	Carbon steels (C > 0.3%) Alloy steels	- 300 HB	DJ, AH6030	DW, AH6030	DJ, AH9030	DW, AH725	DJ, AH9030	DW, AH6030	-
	Low alloy steels	- 200 HB	DS, AH6030	-	-	DS, AH725	-	DW, AH6030	-
M	Stainless steel	- 200 HB	DS, AH6030	-	-	DS, AH725	-	DW, AH6030	DG, AH725
K	Grey cast irons	150 - 250 HB	DJ, AH9030	DW, AH9030	DJ, T1115	DW, AH725	-	DW, AH9030	-
	Ductile cast irons	150 - 250 HB	DJ, AH9030	DW, AH9030	-	DW, AH725	-	DW, AH9030	-
N	Aluminium alloy	-	DJ, AH725	DW, AH725	DS, AH6030	-	-	DW, AH725	DG, AH725
S	Titanium alloys Heat-resistant alloys	- 40 HRC	DS, AH6030	-	-	DW, AH725	-	DW, AH725	DG, AH725
H	Hardened steel	- 50 HRC	DJ, AH9030	DW, AH9030	-	DW, AH725	-	DW, AH9030	-

STANDARD CUTTING CONDITIONS

ISO	Workpiece material	Hardness	Cutting speed Vc (m/min)	Series L/D	Feed: f (mm/rev)				
					ø12.5 ~ ø14.5	ø15 ~ ø17	ø17.5 ~ ø26	ø27 ~ ø32	ø33 ~ ø54
P	Low carbon steels (C < 0.3) SS400, SM490, S25C, etc. st42-1, St52-3, C25, etc.	- 200 HB	160 - 320	2D, 3D	0.02 - 0.06	0.02 - 0.06	0.04 - 0.1	0.04 - 0.1	0.04 - 0.1
				4D, 5D	0.02 - 0.06	0.02 - 0.06	0.04 - 0.1	0.04 - 0.1	0.04 - 0.1
	Carbon steels (C > 0.3) S45C, S55C, etc. C45, C55, etc.	- 300 HB	80 - 250	2D, 3D	0.04 - 0.1	0.04 - 0.12	0.06 - 0.13	0.06 - 0.15	0.08 - 0.18
				4D, 5D	0.04 - 0.08	0.04 - 0.08	0.06 - 0.1	0.06 - 0.12	0.08 - 0.14
M	Low alloy steels SCM415, etc.	- 200 HB	160 - 250	2D, 3D	0.04 - 0.08	0.04 - 0.08	0.06 - 0.12	0.06 - 0.12	0.06 - 0.14
				4D, 5D	0.04 - 0.08	0.04 - 0.08	0.06 - 0.12	0.06 - 0.12	0.06 - 0.14
	Alloy steels SCM440, SCr420, etc. 42CrMo4, 20Cr4, etc.	- 300 HB	80 - 200	2D, 3D	0.04 - 0.1	0.04 - 0.12	0.06 - 0.13	0.06 - 0.15	0.08 - 0.18
				4D, 5D	0.04 - 0.08	0.04 - 0.08	0.06 - 0.1	0.06 - 0.12	0.08 - 0.14
	Stainless steels (Austenitic) SUS304, SUS316, etc. X5CrNi18-9, X5CrNiMo17-12-2, etc.	- 200 HB	100 - 200	2D, 3D	0.02 - 0.08	0.02 - 0.08	0.04 - 0.1	0.04 - 0.12	0.04 - 0.12
				4D, 5D	0.02 - 0.08	0.02 - 0.08	0.04 - 0.1	0.04 - 0.12	0.04 - 0.12
Stainless steels (Martensitic and ferritic) SUS430, SUS416, etc. X6Cr17, X20Cr13, etc.	- 200 HB	100 - 220	2D, 3D	0.02 - 0.08	0.02 - 0.08	0.04 - 0.1	0.04 - 0.12	0.04 - 0.12	
			4D, 5D	0.02 - 0.08	0.02 - 0.08	0.04 - 0.1	0.04 - 0.12	0.04 - 0.12	
Stainless steels (Precipitation hardening) SUS630, etc. X5CrNiCuNb16-4, etc.	-	80 - 120	2D, 3D	0.04 - 0.08	0.04 - 0.08	0.04 - 0.08	0.04 - 0.1	0.06 - 0.1	
			4D, 5D	0.04 - 0.08	0.04 - 0.08	0.04 - 0.08	0.04 - 0.1	0.06 - 0.1	
K	Grey cast irons FC250, etc., 250, etc.	150 - 250 HB	80 - 250	2D, 3D	0.06 - 0.12	0.06 - 0.12	0.06 - 0.15	0.06 - 0.18	0.08 - 0.2
				4D, 5D	0.06 - 0.1	0.06 - 0.1	0.06 - 0.12	0.06 - 0.14	0.08 - 0.16
N	Aluminium alloy A2017, ADC12, etc. AlCu4SiMg, AlSi11Cu3, etc.	-	200 - 400	2D, 3D	0.1 - 0.12	0.1 - 0.15	0.15 - 0.2	0.15 - 0.2	0.15 - 0.25
				4D, 5D	0.08 - 0.12	0.08 - 0.12	0.12 - 0.16	0.12 - 0.16	0.12 - 0.2
S	Heat-resistant alloys Inconel 718, etc.	- 40 HRC	20 - 60	2D, 3D	0.04 - 0.08	0.04 - 0.08	0.04 - 0.1	0.04 - 0.1	0.04 - 0.1
				4D, 5D	0.04 - 0.08	0.04 - 0.08	0.04 - 0.1	0.04 - 0.1	0.04 - 0.1
H	Titanium alloys Ti-6Al-4V, etc.	- 40 HRC	40 - 120	2D, 3D	0.06 - 0.1	0.06 - 0.1	0.06 - 0.12	0.06 - 0.12	0.06 - 0.12
				4D, 5D	0.06 - 0.08	0.06 - 0.08	0.06 - 0.1	0.06 - 0.1	0.06 - 0.1
H	Hardened steel	- 50 HRC	40 - 100	2D, 3D	0.04 - 0.08	0.04 - 0.08	0.04 - 0.1	0.04 - 0.1	0.04 - 0.1
				4D, 5D	0.04 - 0.08	0.04 - 0.08	0.04 - 0.08	0.04 - 0.08	0.04 - 0.08

STANDARD CUTTING CONDITIONS FOR DG TYPE CHIPBREAKER

ISO	Workpiece material	Hardness	Cutting speed Vc (m/min)	Series L/D	Feed: f (mm/rev)	
					ø27 ~ ø32	ø33 ~ ø54
P	Low carbon steels (C < 0.3) SS400, SM490, S25C, etc. st42-1, St52-3, C25, etc.	- 200 HB	60 - 180	2D, 3D 4D, 5D	0.04 - 0.1	

- When using the smaller side of the diameter range, the feed rate should be set lower.
- When using DW insert for work materials of 40 HRC, the feed rate should be set below 50%.
- For difficult-to-cut materials (heat-resistant alloys, etc.), the cutting speed should be set 25% below that of carbon steels.
- High speed machining means cutting speeds over 150 m/min.
- For high-feed machining, apply a feed rate that is approximately 1.5 times the standard feed conditions.
- When using DW insert for troubleshooting, use it within the range of standard cutting conditions.
- DG type chipbreaker is suitable for heavy machines that have low-rpm spindles. If chatter occurs, a lower feed rate is recommended.

TUNGDRILLTWISTED

TDXCF chamfering tool

Chamfering tool for TungDrillTwisted and TungSix-Drill

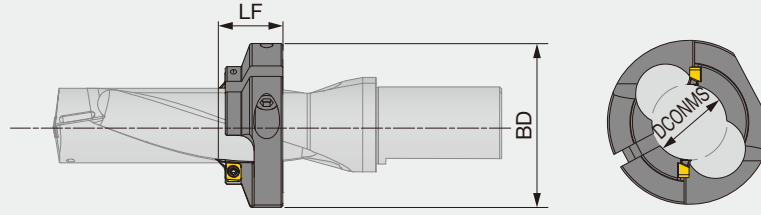

Designation	DCONMS	BD	LF	Application drill	L/D = 2		L/D = 3		L/D = 4		L/D = 5	
					TDX***F	TDX***W	TDX***F	TDX***W	TDX***F	TDX***W	TDX***F	TDX***W
TDXCF180L25	17.3	49	25	TDX175*25-*	13	18.8	30.5	36.3	48	53.8	65.5	71.3
TDXCF180L25	17.3	49	25	TDX180*25-*	14	19.9	32	37.9	50	55.9	68	73.9
TDXCF190L25	18.1	49	25	TDX185*25-*	15	21.1	33.5	39.6	52	58.1	70.5	76.6
TDXCF190L25	18.1	49	25	TDX190*25-*	16	22.2	35	41.2	54	60.2	73	79.2
TDXCF200L25	19.1	49	25	TDX195*25-*	17	23.4	36.5	42.9	56	62.4	75.5	81.9
TDXCF200L25	19.1	49	25	TDX200*25-*	20	24.5	40	44.5	59	64.5	79	84.5
TDXCF210L25	20.1	49	25	TDX205*25-*	21	25.7	41.5	46.2	61	66.7	81.5	87.2
TDXCF210L25	20.1	49	25	TDX210*25-*	22	26.8	43	47.8	63	68.8	84	89.8
TDXCF220L25	21.1	49	25	TDX215*25-*	23	28	44.5	49.5	65	71	86.5	92.5
TDXCF220L25	21.1	49	25	TDX220*25-*	24	29.1	46	51.1	67	73.1	89	95.1
TDXCF230L25	22.1	49	25	TDX225*25-*	25	30.3	47.5	52.8	69	75.3	91.5	97.8
TDXCF230L25	22.1	49	25	TDX230*25-*	26	31.4	49	54.4	71	77.4	94	100.4
TDXCF240L25	23.1	49	25	TDX235*25-*	27	32.6	50.5	56.1	73	79.6	96.5	103.1
TDXCF240L25	23.1	49	25	TDX240*25-*	28	33.7	52	57.7	75	81.7	99	105.7
TDXCF250L25	23.95	49	25	TDX245*25-*	29	34.9	53.5	59.4	77	83.9	101.5	108.4
TDXCF250L25	23.95	49	25	TDX250*25-*	30	36	55	61	79	86	104	111
TDXCF260L30	24.95	64	30	TDX255*25-*	26	32.2	51.5	57.7	76	83.2	101.5	108.7
TDXCF260L30	24.95	64	30	TDX260*25-*	27	33.3	53	59.3	78	85.3	104	111.3
TDXCF270L30	25.9	64	30	TDX270*32-*	29	35.6	56	62.6	82	89.6	109	116.6
TDXCF280L30	26.9	64	30	TDX280*32-*	30.3	37.9	58.3	65.9	86	93.9	114	121.9
TDXCF290L30	27.9	64	30	TDX290*32-*	32.3	40.2	61.3	69.2	90	98.2	119	127.2
TDXCF300L30	28.9	64	30	TDX300*32-*	34.3	42.5	64.3	72.5	94	102.5	124	132.5
TDXCF310L30	29.9	64	30	TDX310*32-*	36.3	44.8	67.3	75.8	98	106.8	129	137.8
TDXCF320L30	30.9	64	30	TDX320*32-*	38.3	47.1	70.3	79.1	102	111.1	134	143.1

SPARE PARTS

Designation	Screw for insert	Screw for ring	Wrench for insert	Wrench for ring
TDXCF180... - TDXCF250...	CSPB-4S	CM6X16	IP-15D	P-5
TDXCF260... - TDXCF320...	CSPB-4S	CM8X1.25X20-A	IP-15D	P-6

Recommended clamping torque (N·m): CSPB-4S = 3.5

INSERT

XHGX-45A

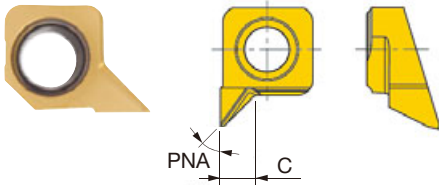

P	Steel	★										
M	Stainless	★										
K	Cast iron	★										
N	Non-ferrous	☆										
S	Superalloys	★										
H	Hard materials	★										

★ : First choice
☆ : Second choice

Designation	PNA	C	Coated	
			GH130	
XHGX090700R-45A	45°	2.5	●	

● : Line up

Caution in mounting the chamfering tool on the drill body

- Place the ring on the drill body and match the positions of flutes on drill and ring. Temporarily clamp the ring with the ring screw tightened lightly.
- Place the inserts, and tighten the insert screw lightly.
- Adjust the ring position with a presetter, height gauge, or vernier caliper, and securely tighten the ring screw, then the insert screw.

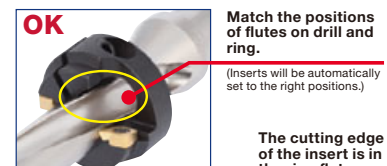

EZ sleeve

Eccentric sleeve for TungDrillTwisted and TungSix-Drill

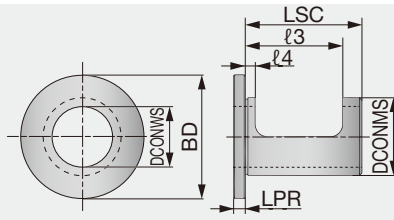

Designation	DCONWS	DCONMS	BD	LSC	LPR	ℓ3	ℓ4	Hole diameter adjustment	Cutting edge height adjustment
EZ2025	20	25	46	49	5	32.5	4	+0.4 ~ - 0.2	+0.2 ~ - 0.15
EZ2532	25	32	51	52	5	38	4	+0.4 ~ - 0.2	+0.2 ~ - 0.15
EZ3240	32	40	54	62	5	43	4	+0.4 ~ - 0.2	+0.2 ~ - 0.15
EZ4050	40	50	69	63	5	55	4	+0.6 ~ - 0.2	+0.3 ~ - 0.2

SPARE PARTS

Designation	Wrench
EZ...	P-2.5

TUNGDRILLBIG

TDB, TDS cartridge set

Indexable drill, L/D = 2.5, with tool diameter adjustability

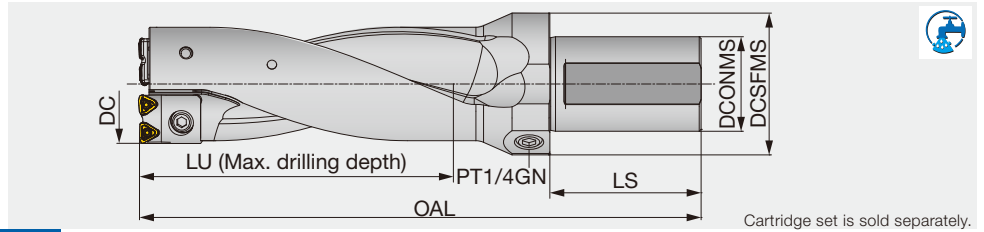

Cartridge set is sold separately.

Body Designation	Cartridge set Designation	DC	DCONMS	DCSFMS	LU	LS	OAL	WT(kg)	Setting plate Designation	Setting plate Thickness (mm)	Insert
TDB55-56F50-2.5	TDSCA55-56	55	50	75	140	80	262	3.2	-	-	WWWU08X408R-D*
TDB55-56F50-2.5	TDSCA55-56	56	50	75	140	80	262	3.2	AP0801	0.5	WWWU08X408R-D*
TDB57-62F50-2.5	TDSCA57-62	57	50	75	155	80	282	3.6	-	-	WWWU08X408R-D*
TDB57-62F50-2.5	TDSCA57-62	58	50	75	155	80	282	3.6	AP0801	0.5	WWWU08X408R-D*
TDB57-62F50-2.5	TDSCA57-62	59	50	75	155	80	282	3.6	AP0802	1	WWWU08X408R-D*
TDB57-62F50-2.5	TDSCA57-62	60	50	75	155	80	282	3.6	AP0803	1.5	WWWU08X408R-D*
TDB57-62F50-2.5	TDSCA57-62	61	50	75	155	80	282	3.6	AP0804	2	WWWU08X408R-D*
TDB57-62F50-2.5	TDSCA57-62	62	50	75	155	80	282	3.6	AP0805	2.5	WWWU08X408R-D*
TDB63-66F50-2.5	TDSCA63-66	63	50	75	165	80	297	4.2	-	-	WWWU08X408R-D*
TDB63-66F50-2.5	TDSCA63-66	64	50	75	165	80	297	4.2	AP0801	0.5	WWWU08X408R-D*
TDB63-66F50-2.5	TDSCA63-66	65	50	75	165	80	297	4.2	AP0802	1	WWWU08X408R-D*
TDB63-66F50-2.5	TDSCA63-66	66	50	75	165	80	297	4.2	AP0803	1.5	WWWU08X408R-D*
TDB67-73F50-2.5	TDSCA67-73	67	50	75	183	80	322	5	-	-	WWWU09X510R-D*
TDB67-73F50-2.5	TDSCA67-73	68	50	75	183	80	322	5	AP1101	0.5	WWWU09X510R-D*
TDB67-73F50-2.5	TDSCA67-73	69	50	75	183	80	322	5	AP1102	1	WWWU09X510R-D*
TDB67-73F50-2.5	TDSCA67-73	70	50	75	183	80	322	5	AP1103	1.5	WWWU09X510R-D*
TDB67-73F50-2.5	TDSCA67-73	71	50	75	183	80	322	5	AP1104	2	WWWU09X510R-D*
TDB67-73F50-2.5	TDSCA67-73	72	50	75	183	80	322	5	AP1105	2.5	WWWU09X510R-D*
TDB67-73F50-2.5	TDSCA67-73	73	50	75	183	80	322	5	AP1106	3	WWWU09X510R-D*
TDB74-80F50-2.5	TDSCA74-80	74	50	75	200	80	333	5.7	-	-	WWWU11X512R-D*
TDB74-80F50-2.5	TDSCA74-80	75	50	75	200	80	333	5.7	AP1101	0.5	WWWU11X512R-D*
TDB74-80F50-2.5	TDSCA74-80	76	50	75	200	80	333	5.7	AP1102	1	WWWU11X512R-D*
TDB74-80F50-2.5	TDSCA74-80	77	50	75	200	80	333	5.7	AP1103	1.5	WWWU11X512R-D*
TDB74-80F50-2.5	TDSCA74-80	78	50	75	200	80	333	5.7	AP1104	2	WWWU11X512R-D*
TDB74-80F50-2.5	TDSCA74-80	79	50	75	200	80	333	5.7	AP1105	2.5	WWWU11X512R-D*
TDB74-80F50-2.5	TDSCA74-80	80	50	75	200	80	333	5.7	AP1106	3	WWWU11X512R-D*

Body

SPARE PARTS

Designation	① Setting plate screw	Plug Screw	② Cartridge screw	③ Setting plate 1	③ Setting plate 2	③ Setting plate 3	③ Setting plate 4	③ Setting plate 5	③ Setting plate 6	Wrench for setting plate	Wrench for cartridge	Wrench for plug	④ Washer
TDB55-56F50-2.5	CSTB-3	PT1/4GN	CM5X0.8X12	AP0801	-	-	-	-	-	T-9D	P-4	P-6	5.3X10X1
TDB57-62F50-2.5	CSTB-3	PT1/4GN	CM5X0.8X12	AP0801	AP0802	AP0803	AP0804	AP0805	-	T-9D	P-4	P-6	5.3X10X1
TDB63-66F50-2.5	CSTB-3	PT1/4GN	CHHM6-15	AP0801	AP0802	AP0803	-	-	-	T-9D	P-5	P-6	6.4X12.5X1.6
TDB67-73F50-2.5	CSTB-3	PT1/4GN	CM6X16	AP1101	AP1102	AP1103	AP1104	AP1105	AP1106	T-9D	P-5	P-6	6.4X12.5X1.6
TDB74-80F50-2.5	CSTB-3	PT1/4GN	CM6X16	AP1101	AP1102	AP1103	AP1104	AP1105	AP1106	T-9D	P-5	P-6	6.4X12.5X1.6

Cartridge set

SPARE PARTS

Designation	⑤ Insert screw	Wrench
TDSCA55 - 56	CSTB-3	T-9F
TDSCA57 - 62	CSTB-3	T-9F
TDSCA63 - 66	CSTB-3	T-9F
TDSCA67 - 73	CSTB-4	T-15F
TDSCA74 - 80	CSTB-5	T-20F

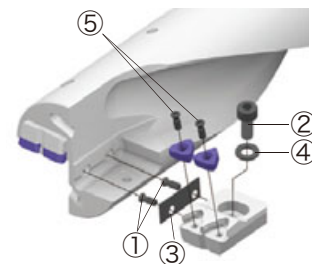

Cartridge

SPARE PARTS

Designation	Insert screw (x2)	Setting plate screw
TDS08CA-C-55-56	CSTB-3	-
TDS08CA-C-57-62	CSTB-3	-
TDS08CA-C-63-66	CSTB-3	-
TDS09CA-C-67-73	CSTB-4	-
TDS11CA-C-74-80	CSTB-5	-

SPARE PARTS

Designation	Insert screw (x2)	Setting plate screw (x2)
TDS08CA-P-55-56	CSTB-3	CSTB-3
TDS08CA-P-57-62	CSTB-3	CSTB-3
TDS08CA-P-63-66	CSTB-3	CSTB-3
TDS09CA-P-67-73	CSTB-4	CSTB-3
TDS11CA-P-74-80	CSTB-5	CSTB-3

Recommended clamping torque (N·m): CSTB-3 = 2.3, CSTB-4 = 3.5, CSTB-5 = 5

Reference pages: Inserts → **J082**, Standard cutting conditions → **J083**



INSERT

DJ

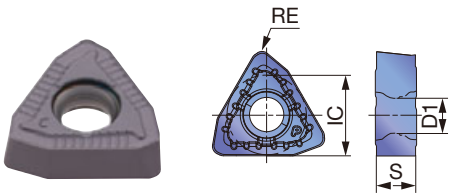

P	Steel	☆	★							
M	Stainless	★	☆							
K	Cast iron	☆	★							
N	Non-ferrous	★	☆							
S	Superalloys	★	☆							
H	Hard materials	★	☆							

★ : First choice
☆ : Second choice

Designation	IC	S	Coated								D1	RE	DCN	DCX	
			AH3135	AH9030											
WWMU08X408R-DJ	8	3.9	●	●								3.4	0.8	55	66
WWMU09X510R-DJ	9.7	4.9	●	●								4.4	1	67	73
WWMU11X512R-DJ	11.3	5.7	●	●								5.5	1.2	74	80

● : Line up

DS

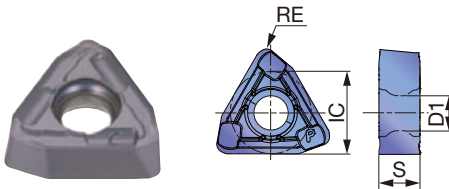

P	Steel	★								
M	Stainless	★								
K	Cast iron									
N	Non-ferrous									
S	Superalloys	★								
H	Hard materials									

★ : First choice
☆ : Second choice

Designation	IC	S	Coated								D1	RE	DCN	DCX	
			AH6030												
WWMU08X408R-DS	8	3.9	●									3.4	0.8	55	66
WWMU09X510R-DS	9.7	4.9	●									4.4	1	67	73
WWMU11X512R-DS	11.3	5.7	●									5.5	1.2	74	80

● : Line up

STANDARD CUTTING CONDITIONS

ISO	Workpiece material	Hardness	Priority	Chip breakers	Grade	Cutting speed Vc (m/min)	Feed: f (mm/rev)			Grade
							DC (mm)			
							ø55 - ø56	ø57 - ø73	ø74 - ø80	
P	Low carbon steels (C<0.3) SS400, SM490, S25C, etc. st42-1, St52-3, C25, etc.	- 200 HB	First choice	DS	AH6030	160 - 250	0.04 - 0.1	0.04 - 0.1	0.04 - 0.1	Insert
			Wear resistance	DJ	AH9030	160 - 320	0.04 - 0.1	0.04 - 0.1	0.04 - 0.1	
	Carbon steels (C>0.3) S45C, S55C, etc. C45, C55, etc.	- 300 HB	First choice	DJ	AH9030	80 - 250	0.06 - 0.16	0.06 - 0.18	0.08 - 0.2	Ext. Toolholder
			Fracture resistance	DJ	AH3135	80 - 250	0.04 - 0.13	0.04 - 0.15	0.04 - 0.16	
	Low alloy steels SCM415, etc. 18CrMo4, etc.	- 200 HB	First choice	DS	AH6030	160 - 250	0.04 - 0.12	0.04 - 0.12	0.04 - 0.12	Ext. Toolholder
			Wear resistance	DJ	AH9030	160 - 250	0.06 - 0.14	0.06 - 0.14	0.06 - 0.14	
	Alloy steels SCM440, SCr420, etc. 42CrMo4, 20Cr4, etc.	- 300 HB	First choice	DJ	AH9030	80 - 200	0.06 - 0.16	0.06 - 0.18	0.08 - 0.2	Int. Toolholder
			Fracture resistance	DJ	AH3135	80 - 200	0.04 - 0.13	0.04 - 0.14	0.04 - 0.15	
M	Stainless steels (Austenitic) SUS304, SUS316, etc. X5CrNi189, X5CrNiMo17-12-2, etc.	- 200 HB	First choice	DS	AH6030	100 - 200	0.04 - 0.12	0.04 - 0.12	0.04 - 0.12	Threading
			—	DJ	AH3135	100 - 200	0.04 - 0.12	0.04 - 0.12	0.04 - 0.12	
	Stainless steel (Martensitic and ferritic) SUS430, etc. X6Cr17, X12CrS13, etc.	- 200 HB	First choice	DS	AH6030	100 - 200	0.04 - 0.12	0.04 - 0.12	0.04 - 0.12	Grooving
			—	DJ	AH3135	100 - 200	0.04 - 0.12	0.04 - 0.12	0.04 - 0.12	
Stainless steels (Precipitation hardening) SUS630, etc. X5CrNiCuNb16-4, etc.	-	First choice	DS	AH6030	80 - 120	0.04 - 0.1	0.04 - 0.1	0.04 - 0.1	Miniature tool	
		—	DJ	AH3135	80 - 120	0.04 - 0.1	0.04 - 0.1	0.04 - 0.1		
K	Grey cast irons FC250, etc. 250, etc.	150 - 250 HB	First choice	DJ	AH9030	80 - 250	0.06 - 0.18	0.08 - 0.2	0.08 - 0.22	Miniature tool
			Fracture resistance	DJ	AH3135	80 - 200	0.06 - 0.15	0.08 - 0.16	0.08 - 0.18	
	Ductile cast irons FCD700, etc. 700-2, etc.	150 - 250 HB	First choice	DJ	AH9030	80 - 200	0.06 - 0.16	0.06 - 0.18	0.08 - 0.2	Milling cutter
			Fracture resistance	DJ	AH3135	80 - 150	0.06 - 0.15	0.08 - 0.16	0.08 - 0.18	
N	Aluminium alloy	-	First choice	DS	AH6030	200 - 400	0.1 - 0.2	0.1 - 0.23	0.1 - 0.25	Milling cutter
			—	DJ	AH9030	200 - 400	0.1 - 0.2	0.1 - 0.23	0.1 - 0.25	
S	Heat-resistant alloys Inconel718, etc.	- 40 HRC	First choice	DS	AH6030	20 - 60	0.04 - 0.08	0.04 - 0.1	0.04 - 0.1	Endmill
			—	DJ	AH3135	20 - 60	0.04 - 0.08	0.04 - 0.1	0.04 - 0.1	
	Titanium alloys Ti-6Al-4V, etc.	- 40 HRC	First choice	DS	AH6030	40 - 120	0.06 - 0.12	0.06 - 0.14	0.06 - 0.14	Drilling tool
			—	DJ	AH3135	40 - 120	0.06 - 0.12	0.06 - 0.14	0.06 - 0.14	
H	Hardened steel < 40HRC	- 50 HRC	First choice	DJ	AH9030	50 - 100	0.04 - 0.08	0.04 - 0.1	0.04 - 0.1	Drilling tool
			Fracture resistance	DJ	AH3135	40 - 80	0.04 - 0.08	0.04 - 0.1	0.04 - 0.1	

Caution

Machine

- Use drills on a fully covered machine to maintain safety.
- Use drills on a high powered machine such as a BT50.
- Figure on right shows reference of required machine power.

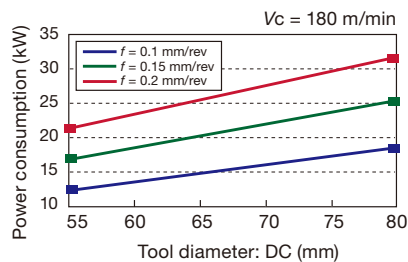

Cutting coolant

- Internal coolant supply is recommended.
- Coolant pressure higher than 1MPa is essential.
- Use water soluble type coolant.



TUNGDRILLBIG

TDB, TDX cartridge set

Indexable drill, L/D = 2.5, with tool diameter adjustability

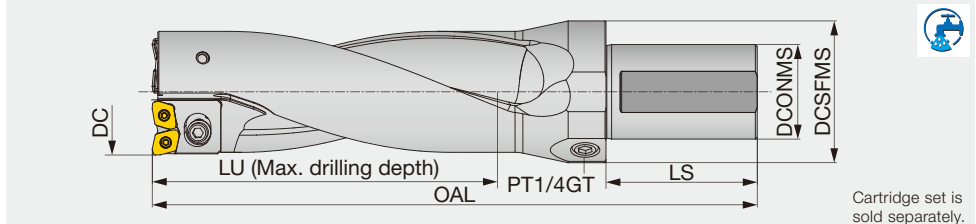

Cartridge set is sold separately.

Body Designation	Cartridge set Designation	DC	DCONMS	DCSFMS	LU	LS	OAL	WT(kg)	Setting plate Designation	Setting plate Thickness (mm)	Insert
TDB55-56F50-2.5	TDXCA55-56	55	50	75	140	80	260	3.2	-	-	XPMT08T308R-D*
TDB55-56F50-2.5	TDXCA55-56	56	50	75	140	80	260	3.2	AP0801	0.5	XPMT08T308R-D*
TDB57-62F50-2.5	TDXCA57-62	57	50	75	155	80	280	3.6	-	-	XPMT08T308R-D*
TDB57-62F50-2.5	TDXCA57-62	58	50	75	155	80	280	3.6	AP0801	0.5	XPMT08T308R-D*
TDB57-62F50-2.5	TDXCA57-62	59	50	75	155	80	280	3.6	AP0802	1	XPMT08T308R-D*
TDB57-62F50-2.5	TDXCA57-62	60	50	75	155	80	280	3.6	AP0803	1.5	XPMT08T308R-D*
TDB57-62F50-2.5	TDXCA57-62	61	50	75	155	80	280	3.6	AP0804	2	XPMT08T308R-D*
TDB57-62F50-2.5	TDXCA57-62	62	50	75	155	80	280	3.6	AP0805	2.5	XPMT08T308R-D*
TDB63-66F50-2.5	TDXCA63-66	63	50	75	165	80	295	4.2	-	-	XPMT08T308R-D*
TDB63-66F50-2.5	TDXCA63-66	64	50	75	165	80	295	4.2	AP0801	0.5	XPMT08T308R-D*
TDB63-66F50-2.5	TDXCA63-66	65	50	75	165	80	295	4.2	AP0802	1	XPMT08T308R-D*
TDB63-66F50-2.5	TDXCA63-66	66	50	75	165	80	295	4.2	AP0803	1.5	XPMT08T308R-D*
TDB67-73F50-2.5	TDXCA67-73	67	50	75	183	80	320	5	-	-	XPMT110412R-D*
TDB67-73F50-2.5	TDXCA67-73	68	50	75	183	80	320	5	AP1101	0.5	XPMT110412R-D*
TDB67-73F50-2.5	TDXCA67-73	69	50	75	183	80	320	5	AP1102	1	XPMT110412R-D*
TDB67-73F50-2.5	TDXCA67-73	70	50	75	183	80	320	5	AP1103	1.5	XPMT110412R-D*
TDB67-73F50-2.5	TDXCA67-73	71	50	75	183	80	320	5	AP1104	2	XPMT110412R-D*
TDB67-73F50-2.5	TDXCA67-73	72	50	75	183	80	320	5	AP1105	2.5	XPMT110412R-D*
TDB67-73F50-2.5	TDXCA67-73	73	50	75	183	80	320	5	AP1106	3	XPMT110412R-D*
TDB74-80F50-2.5	TDXCA74-80	74	50	75	200	80	330	5.7	-	-	XPMT110412R-D*
TDB74-80F50-2.5	TDXCA74-80	75	50	75	200	80	330	5.7	AP1101	0.5	XPMT110412R-D*
TDB74-80F50-2.5	TDXCA74-80	76	50	75	200	80	330	5.7	AP1102	1	XPMT110412R-D*
TDB74-80F50-2.5	TDXCA74-80	77	50	75	200	80	330	5.7	AP1103	1.5	XPMT110412R-D*
TDB74-80F50-2.5	TDXCA74-80	78	50	75	200	80	330	5.7	AP1104	2	XPMT110412R-D*
TDB74-80F50-2.5	TDXCA74-80	79	50	75	200	80	330	5.7	AP1105	2.5	XPMT110412R-D*
TDB74-80F50-2.5	TDXCA74-80	80	50	75	200	80	330	5.7	AP1106	3	XPMT110412R-D*

Body

SPARE PARTS

Designation	① Setting plate screw	Plug Screw	② Cartridge screw	③ Setting plate 1	③ Setting plate 2	③ Setting plate 3	③ Setting plate 4	③ Setting plate 5	③ Setting plate 6	Wrench for setting plate	Wrench for cartridge	Wrench for plug	④ Washer
TDB55-56F50-2.5	CSTB-3	PT1/4GN	CM5X0.8X12	AP0801	-	-	-	-	-	T-9D	P-4	P-6	5.3X10X1
TDB57-62F50-2.5	CSTB-3	PT1/4GN	CM5X0.8X12	AP0801	AP0802	AP0803	AP0804	AP0805	-	T-9D	P-4	P-6	5.3X10X1
TDB63-66F50-2.5	CSTB-3	PT1/4GN	CHHM6-15	AP0801	AP0802	AP0803	-	-	-	T-9D	P-5	P-6	6.4X12.5X1.6
TDB67-73F50-2.5	CSTB-3	PT1/4GN	CM6X16	AP1101	AP1102	AP1103	AP1104	AP1105	AP1106	T-9D	P-5	P-6	6.4X12.5X1.6
TDB74-80F50-2.5	CSTB-3	PT1/4GN	CM6X16	AP1101	AP1102	AP1103	AP1104	AP1105	AP1106	T-9D	P-5	P-6	6.4X12.5X1.6

Cartridge set

SPARE PARTS

Designation	⑤ Insert screw	Wrench
TDXCA55 - 56	CSTB-3	T-9F
TDXCA57 - 62	CSTB-3	T-9F
TDXCA63 - 66	CSTB-3	T-9F
TDXCA67 - 73	CSTB-4	T-15F
TDXCA74 - 80	CSTB-4	T-15F

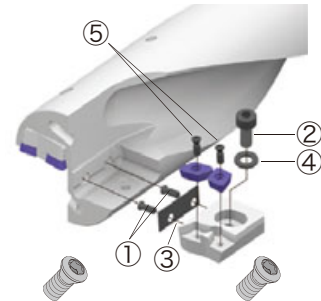

Cartridge

SPARE PARTS

Designation	Insert screw (x2)	Setting plate screw
TDX08CA-C0	CSTB-3	-
TDX08CA-C1	CSTB-3	-
TDX08CA-C2	CSTB-3	-
TDX11CA-C1	CSTB-4	-
TDX11CA-C2	CSTB-4	-

SPARE PARTS

Designation	Insert screw (x2)	Setting plate screw (x2)
TDX08CA-P0	CSTB-3	CSTB-3
TDX08CA-P1	CSTB-3	CSTB-3
TDX08CA-P2	CSTB-3	CSTB-3
TDX11CA-P1	CSTB-4	CSTB-3
TDX11CA-P2	CSTB-4	CSTB-3

Recommended clamping torque (N·m): CSTB-3=2.3, CSTB-4=3.5

Reference pages: Inserts → **J085 - J086**, Standard cutting conditions → **J086 - J087**

INSERT

DJ

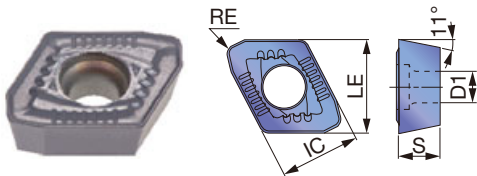

P	Steel			★	☆					
M	Stainless	☆		★						
K	Cast iron		☆	☆	★					
N	Non-ferrous	☆		★						
S	Superalloys	☆		★	☆					
H	Hard materials	☆		★	☆					

★ : First choice
☆ : Second choice

Designation	IC	LE	Coated				S	D1	RE	DCN	DCX
			AH725	T1115	AH6030	AH9030					
XPMT08T308R-DJ	8.5	9.9	●	●	●	●	3.97	3.4	0.8	55	66
XPMT110412R-DJ	11.2	12.5	●	●	●	●	4.76	4.4	1.2	67	80

● : Line up

DS

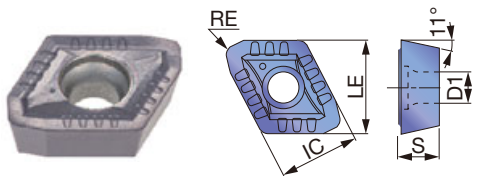

P	Steel	☆	★							
M	Stainless	☆	★							
K	Cast iron									
N	Non-ferrous	☆								
S	Superalloys	☆	★							
H	Hard materials									

★ : First choice
☆ : Second choice

Designation	IC	LE	Coated		S	D1	RE	DCN	DCX
			AH725	AH6030					
XPMT08T308R-DS	8.5	9.9	●	●	3.97	3.4	0.8	55	66
XPMT110412R-DS	11.2	12.5	●	●	4.76	4.4	1.2	67	80

● : Line up

DW

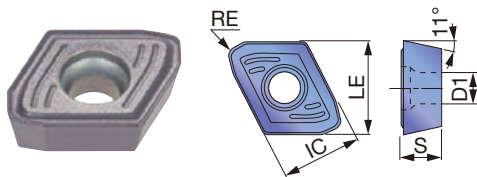

P	Steel	☆	★	☆						
M	Stainless	☆	★	☆						
K	Cast iron		☆	★						
N	Non-ferrous	☆	★							
S	Superalloys	☆	★	☆						
H	Hard materials	☆	★	☆						

★ : First choice
☆ : Second choice

Designation	IC	LE	Coated			S	D1	RE	DCN	DCX
			AH725	AH6030	AH9030					
XPMT08T308R-DW	8.5	9.9	●	●	●	3.97	3.4	0.8	55	66
XPMT110412R-DW	11.2	12.5	●	●	●	4.76	4.4	1.2	67	80

● : Line up

INSERT

DG

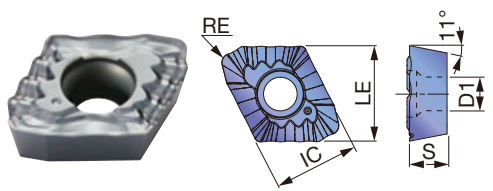

P	Steel	★								
M	Stainless	☆								
K	Cast iron									
N	Non-ferrous	★								
S	Superalloys	☆								
H	Hard materials									

★ : First choice
 ☆ : Second choice

Designation	IC	LE	Coated								S	D1	RE	DCN	DCX	
			AH725													
XPMT08T308R-DG	8.5	9.9	●									3.97	3.4	0.8	55	66
XPMT110412R-DG	11.2	12.5	●									4.76	4.4	1.2	67	80

● : Line up

RECOMMENDED INSERT

ISO	Workpiece material	Hardness	First choice	High feed	High speed	Chipping resistance	Troubleshooting		
							Wear resistance	Surface finish	Chip control
P	Low carbon steels (C ≤ 0.3%)	- 200 HB	DS, AH6030	-	-	DS, AH725	-	DW, AH6030	DG, AH725
	Carbon steels (C > 0.3%) Alloy steels	- 300 HB	DJ, AH6030	DW, AH6030	DJ, AH9030	DW, AH725	DJ, AH9030	DW, AH6030	-
	Low alloy steels	- 200 HB	DS, AH6030	-	-	DS, AH725	-	DW, AH6030	-
M	Stainless steel	- 200 HB	DS, AH6030	-	-	DS, AH725	-	DW, AH6030	DG, AH725
K	Grey cast irons	150 - 250 HB	DJ, AH9030	DW, AH9030	DJ, T1115	DW, AH725	-	DW, AH9030	-
	Ductile cast irons	150 - 250 HB	DJ, AH9030	DW, AH9030	-	DW, AH725	-	DW, AH9030	-
N	Aluminium alloy	-	DJ, AH725	DW, AH725	DS, AH6030		-	DW, AH725	DG, AH725
S	Titanium alloys Heat-resistant alloys	- 40 HRC	DS, AH6030	-	-	DW, AH725	-	DW, AH725	DG, AH725
H	Hardened steel	- 50 HRC	DJ, AH9030	DW, AH9030	-	DW, AH725	-	DW, AH9030	-

STANDARD CUTTING CONDITIONS

ISO	Workpiece material	Hardness	Cutting speed		Feed: f (mm/rev)	
			V_c (m/min)	$\phi 55 \sim \phi 62$	$\phi 63 \sim \phi 73$	$\phi 74 \sim \phi 80$
P	Low carbon steels (C < 0.3) SS400, SM490, S25C, etc. st42-1, St52-3, C25, etc.	- 200 HB	160 - 320	0.04 - 0.1	0.04 - 0.1	0.04 - 0.1
	Carbon steels (C > 0.3) S45C, S55C, etc. C45, C55, etc.	- 300 HB	80 - 250	0.08 - 0.18	0.08 - 0.18	0.1 - 0.2
	Low alloy steels SCM415, etc. 15CrMo5, etc.	- 200 HB	160 - 250	0.04 - 0.16	0.04 - 0.16	0.04 - 0.16
	Alloy steels SCM440, SCr420, etc. 42CrMo4, 20Cr4, etc.	- 300 HB	80 - 200	0.08 - 0.18	0.08 - 0.18	0.08 - 0.2
M	Stainless steels (Austenitic) SUS304, SUS316, etc. X5CrNi18-9, X5CrNiMo17-12-2, etc.	- 200 HB	100 - 200	0.04 - 0.12	0.04 - 0.12	0.06 - 0.14
	Stainless steels (Martensitic and ferritic) SUS430, SUS416, etc. X6Cr17, X20Cr13, etc.	- 200 HB	100 - 200	0.04 - 0.12	0.04 - 0.12	0.06 - 0.14
	Stainless steels (Precipitation hardening) SUS630, etc. X5CrNiCuNb16-4, etc.	-	80 - 120	0.04 - 0.1	0.04 - 0.1	0.06 - 0.12
K	Grey cast irons FC250, etc. 250, etc.	150 - 250 HB	80 - 250	0.08 - 0.2	0.08 - 0.2	0.1 - 0.22
	Ductile cast irons FCD600, etc. 600-3, etc.	150 - 250 HB	80 - 200	0.08 - 0.2	0.08 - 0.2	0.1 - 0.22
N	Aluminium alloy A2017, ADC12, etc. AlCu4SiMg, AlSi11Cu3, etc.	-	200 - 400	0.15 - 0.25	0.15 - 0.25	0.18 - 0.28
S	Heat-resistant alloys	- 40 HRC	20 - 60	0.04 - 0.1	0.04 - 0.1	0.04 - 0.1
	Titanium alloys	- 40 HRC	40 - 120	0.06 - 0.12	0.06 - 0.12	0.06 - 0.12
H	Hardened steel	- 50 HRC	40 - 100	0.04 - 0.1	0.04 - 0.1	0.04 - 0.1

Standard cutting conditions for DG type chipbreaker

ISO	Workpiece material	Hardness	Cutting speed V_c (m/min)	Series L/D	Feed: f (mm/rev)	
					$\phi 27 \sim \phi 32$	$\phi 33 \sim \phi 54$
P	Low carbon steels (C < 0.3) SS400, SM490, S25C, etc. st42-1, St52-3, C25, etc.	- 200 HB	60 - 180	2D, 3D 4D, 5D	0.04 - 0.1	

Caution

Machine

- Use drills on a fully covered machine to maintain safety.
- Use drills on a high powered machine such as a BT50.
- Figure on right shows reference of required machine power.

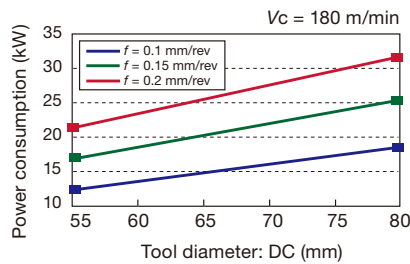

Cutting coolant

- Use water soluble type coolant with internal supply.
- Coolant pressure higher than 1MPa is essential.

TDP L/D=5

Indexable drill with pilot drill

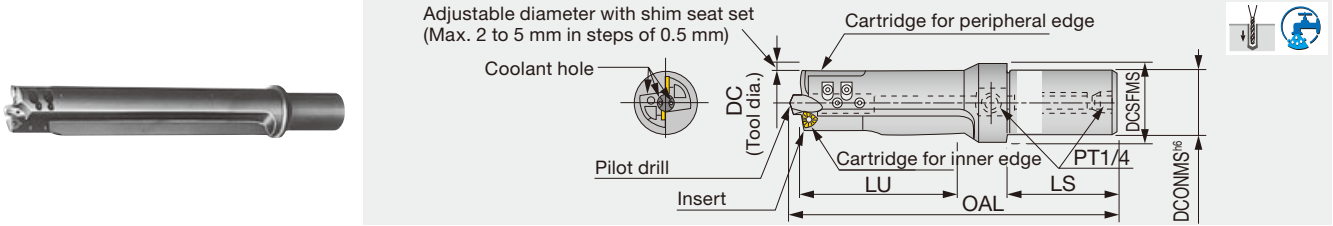

Designation	DC	DCONMS	DCSFMS	OAL	LU	LS	Insert	Pilot drill (included in the package)
TDP30-32	30 ~ 32	32	40	248	150	60	WPMT040208-D3	DP08 (ø8)
TDP37-40	37 ~ 40	40	50	295	185	70	WPMT050308-D3	DP10 (ø10)
TDP40-45	40 ~ 45	40	50	310	200	70	WPMT050308-D3	DP12 (ø12)
TDP45-50	45 ~ 50	40	50	347	225	70	WPMT06T308-D3	DP12 (ø12)
TDP60-65	60 ~ 65	50	58.5	470	300	120	WPMT080412-D3	DP12 (ø12)

Diameter is adjustable with shim seat set. (Max. 2 to 5 mm in steps of 0.5 mm)
 Pilot drill is included, but inserts are sold separately.

L/D = Hole depth / Drill diameter

SPARE PARTS

Designation	Cartridge		Clamping screw			Coolant hole plug screw	Wrench			Coolant hole plug screw	Shim seat set
	for peripheral edge	for inner edge	for insert	Wrench for cartridge	for pilot drill		for insert	Wrench for cartridge	for pilot drill		
TDP30-32	CW04A	CW04B	CSTB-2.5S	BHM4-8	SSHM5-10	PT1/4GN	T-8D	P-2.5	Same for cartridge	P-6	SW04
TDP37-40	CW05A	CW05B	CSTB-3S	BHM4-10	SSHM5-10	PT1/4GN	T-9D	P-2.5	Same for cartridge	P-6	SW05
TDP40-45	CW05A	CW05B	CSTB-3S	BHM4-10	SSHM6-12	PT1/4GN	T-9D	P-2.5	P-3	P-6	SW05
TDP45-50	CW06A	CW06B	CSTB-3.5D	BHM5-14	SSHM6-12	PT1/4GN	T-9D	P-3	Same for cartridge	P-6	SW06
TDP60-65	CW08A	CW08B	CSTB-4M	CHHM5-18 (CM5x0.8x18)	SSHM6-20	PT1/4GN	T-15D	P-4	P-3	P-6	SW08

Recommended clamping torque (N·m): CSTB-2.5S = 1.3, CSTB-3S, CSTB-3.5D = 2.3, CSTB-4M = 3.5
 BHM4-8/BHM4-10 = 2.2, BHM5-14 = 3, CHHM5-18 = 5, SSHM5-10 = 2, SSHM6-12/SSHM6-20 = 3

INSERT

WPMT04/05/06/08-D3

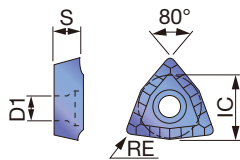

Designation	T313W	IC	S	RE	D1
WPMT040208-D3	●	6.35	2.38	0.8	2.86
WPMT050308-D3	●	7.938	3.18	0.8	3.4
WPMT06T308-D3	●	9.525	3.97	0.8	3.9
WPMT080412-D3	●	12.7	4.76	1.2	4.4

(The chipbreaker shape of WPMT040208-D3 insert is different from the drawing above.)

PILOT DRILL

DP08/10/12

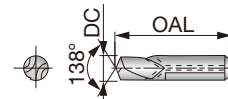

Designation	HSS	DC	OAL
DP08	●	8	42
DP10	●	10	48
DP12	●	12	55

Note: DP08 type drill does not have oil hole.

Package quantity: 1pc
 ●: Line up

STANDARD CUTTING CONDITIONS

ISO	Workpiece material	Hardness	Cutting speed Vc (m/min)	Feed f (mm/rev)
P	Carbon steels	- 300 HB	60 - 70	0.07 - 0.17
	Alloy steels	- 300 HB	60 - 70	0.07 - 0.17
K	Cast iron	150 - 250 HB	70 - 100	0.1 - 0.2

Note: tool Dia. Smaller than ø37 mm, feed should be set less than 0.13 mm/rev for steel, 0.15 mm/rev for cast iron.

Cautionary points in use

- When drilling steel, a water soluble coolant should be used. Coolant pressure of 1MPa or higher and quantity of 10 liter/min or more are essential.
- For tool-rotating applications, side-lock holder with coolant through hole is recommended. (For standard TDP60-65 and 65-70, please check the toolholder that will be used because the mounting shank diameter is ø50.)
- Drilling into stacked plates is not recommended.
- Not suitable for low carbon steels and stainless steels, because of chip control issues.

Drilling Insert (Former products)

● LPMT03X206R-D4, LPMT05X204-D4

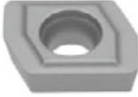
Shape	Designation	Coated			Applicable drill diameter	Applicable drill
		T313W				
	LPMT03X206R-D4	●			ø14 ~ ø17.5	TDJ (Former products)
	LPMT05X204-D4	●			ø14 ~ ø17.5	

● SPMP831DS, SPMP/M**2ERD

Shape	Designation	ISO Metric Designation	Coated			Applicable drill diameter	Applicable drill
			T313W				
	SPMP831DS	SPMT060204-DS	●			ø18 ~ ø19.5	TDR, for Peripheral side (Former products)
	SPMP042ERD	SPMP080308ER-D	●			ø20 ~ ø28.5	
	SPMM322ERD	SPMT090308ER-D	●			ø29 ~ ø34.5	
	SPMM432ERD	SPMT120408ER-D	●			ø35 ~ ø49	

● TPMP**ZDS, TPMP**ZERD, TPMM**ZERD

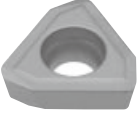
Shape	Designation	Coated			Applicable drill diameter	Applicable drill
		T313W				
	TPMP83ZDS	●			ø18 ~ ø19.5	TDR, for Central side (Former products)
	TPMP04ZERD	●			ø20 ~ ø28.5	
	TPMM32ZERD	●			ø29 ~ ø34.5	
	TPMM43ZERD	●			ø35 ~ ø54	

TPMM43ZERD can be used on the peripheral side.

● WCMT**-D...

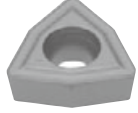
Shape	Designation	Coated			Applicable drill
		AH120	AH140	T313W	
	WCMT050308-DC			●	for counter boring, and drilling.
	WCMT050308-D4	●	●	●	
	WCMT06T308-DC			●	
	WCMT06T308-D4	●	●	●	
	WCMT080412-DC			●	
	WCMT080412-D4			●	

● : Line up



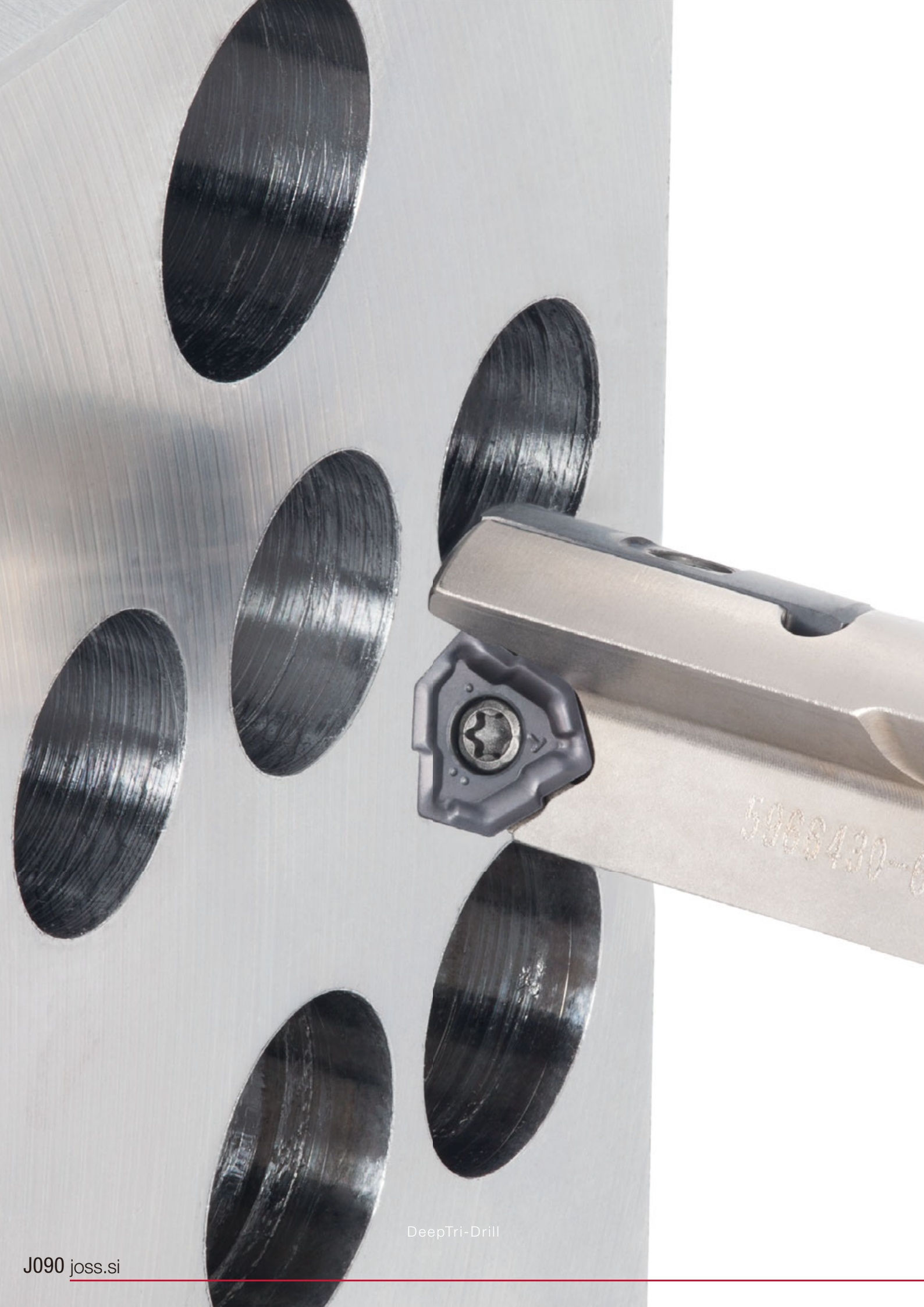

DeepTri-Drill

Deep Hole Drill



DEEPTDRILL

Excellent productivity and stability in deep hole drilling



ø10 mm - ø40 mm / L/D = 8 - 45 for machining centers
OAL ≤ 1650 mm for gundrill machines (standard line-ups)

J007
J092 -



GUNDRILL

Brazed gundrills suitable for small diameter deep hole drilling



ø3 mm - ø12.2 mm / OAL ≤ 1650 mm (standard line-ups)

J007, J092
J113



TRI-FINE

Direct mount drill head with 3-cornered inserts



ø16 mm - ø28 mm

J007
J114 -



FINE-BEAM

Direct mount deep hole drilling heads



ø25 mm - ø89 mm

J007
J114 -, J121 -



UNIDEX

Indexable deep hole drilling heads with adjustable diameters



ø38 mm - ø293.99 mm

J007
J114 -, J129 -



Brazed BTA tools

New solution for BTA drilling with two types of tools: single tube and double tube



ø8 - ø65

J007
J114 -, J150 -



HF drills for deep hole drilling

Indexable deep hole drills for large diameter with high productivity







ø30 mm - ø63 mm, hole depth: L/D=14

J007, J163

Indexable Gundrill guide

★ : First choice
☆ : Second choice

Drill series	Designation	Shape	Drill diameter (mm)	Effective Cutting edge	L/D	Coolant supply	IT class	Straightness (mm)	Machine				Workpiece material						Note	Page	
									Lathes	Vertical machining centers	Horizontal machining centers	Gundrill machines	P	M	K	N	S	H			
DEEPTDRILL	MCTR		ø10 - ø40	1	8 - 45	Int.	IT10-11	0.1/100	○	○	○		★	☆	★	☆	☆	☆	☆	Indexable	J094 -
	MCTRCH		ø14 - ø28	1	25	Int.	IT10-11	0.1/100	○	○	○		★	☆	★	☆	☆	☆	☆	Indexable	J099
	TRLG		ø12 - ø30	1	801.8 - 1652.9 mm	Int.	IT10-11	0.1/100	△	△	△	○	★	☆	★	☆	☆	☆	☆	Indexable	J101-
	TRLGCH		ø14.68 - ø24	1	1652 - 1833.4 mm	Int.	IT10-11	0.1/100	△	△	△	○	★	☆	★	☆	☆	☆	☆	Indexable	J103
Brazed Gundrill	SLJ		ø3 - ø12.2	1	400 - 1650 mm	Int.	IT7-8	0.1/100	△	△	△	○	☆	☆	★	★	☆	☆	Brazed	J113	

DEEPT^{RI}DRILL

Smallest diameter
indexable gun drill
- DeepTri-Drill expansion
down to $\varnothing 10$ mm



Wide range of solutions for various deep hole applications

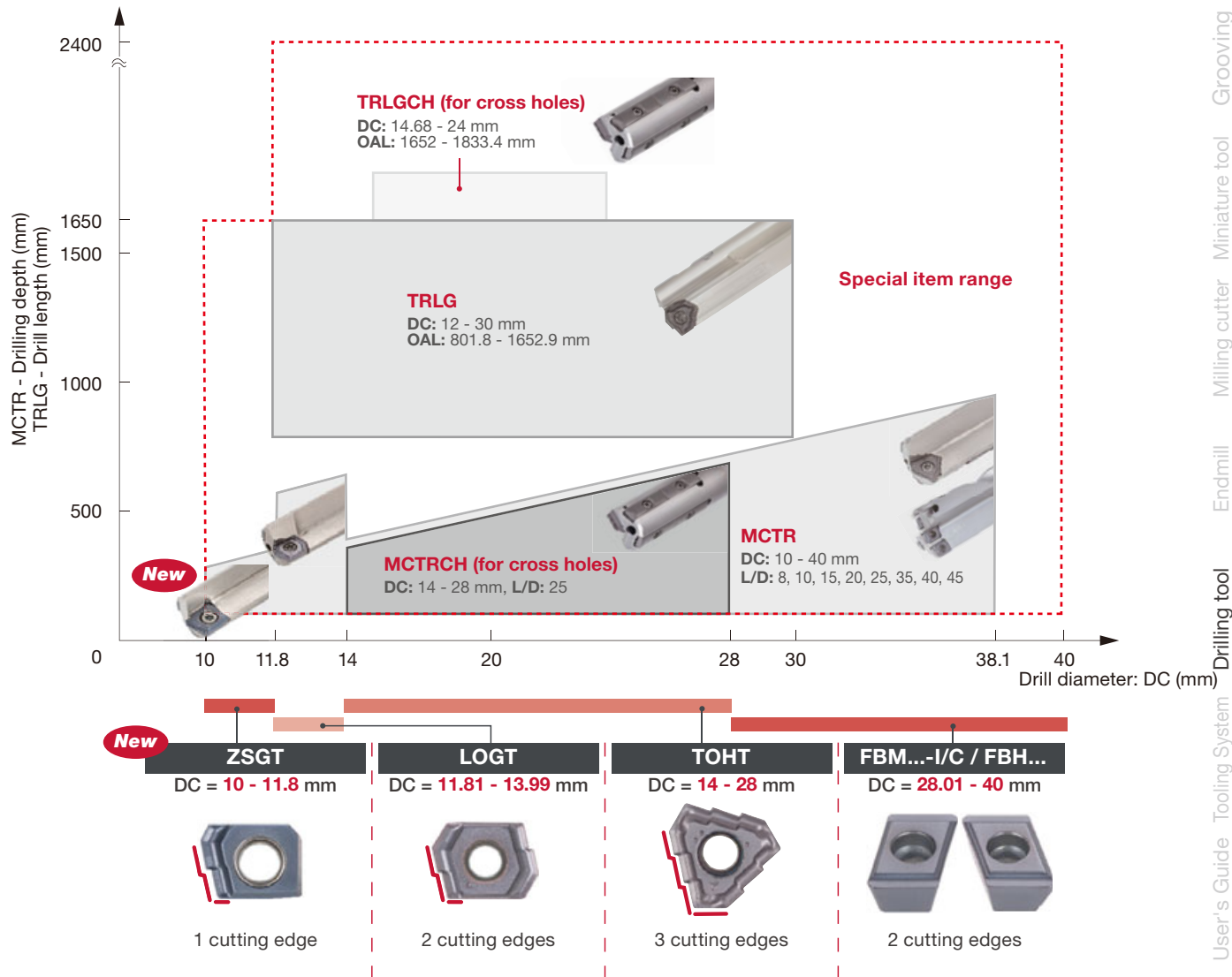

Reference pages: [J094 - J112](#), Technical references → [L092](#)



DEEPT^{RI} DRILL

MCTR-F L/D=8

Indexable gun drill, L/D = 8, for lathes and machining centers

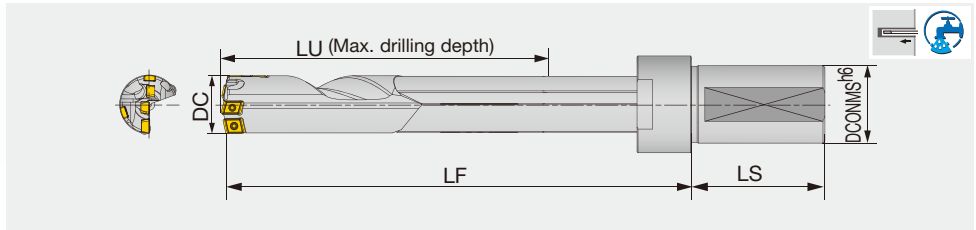

Designation	DC	DCONMS	LU	LS	LF	Insert	Guide pad
MCTR33.10XFM40-8	33.1	40	275	69	350	FBM07*-C, FBM07*-I, FBH08*-P	GP07, GP07-20-120-DC
MCTR39.10XFM40-8	39.1	40	323	69	407	FBM08*-C, FBM07*-I, FBH09*-P	GP08, GP08-25-155-DC

DC	Tool diameter tolerance	Applicable tolerance range of hole diameter
33.1, 39.1	0 / - 0.07	+ 0.05 / - 0.1

Caution:
The drill pipe is blackened to increase the resistance to corrosion, and the finished surface may appear uneven.
This, however, will not affect the performance of the drill.

MCTR L/D=10

Indexable gun drill, L/D = 10, for lathes and machining centers

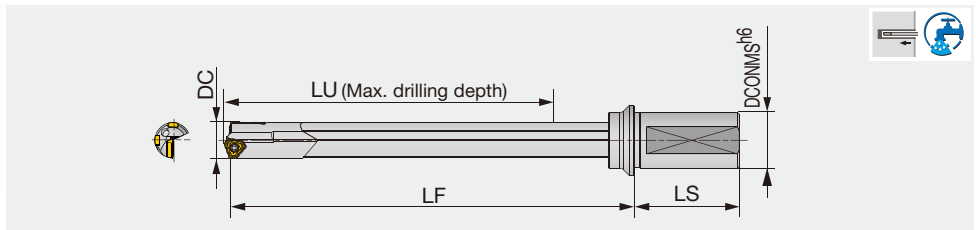

Designation	DC	DCONMS	LU	LS	LF	Insert	Guide pad
MCTR16.00XM25A-10	16	25	172.2	56	209	TOHT08...	GP05-075, GP05-18-075-DC
MCTR16.50XM25A-10	16.5	25	172.2	56	209	TOHT08...	GP05-075, GP05-18-075-DC
MCTR17.00XM25A-10	17	25	182.2	56	220	TOHT08...	GP05-075, GP05-18-075-DC
MCTR17.45XU25.4A-10	17.45	25.4	182.2	56	220	TOHT08..	GP05-075, GP05-18-075-DC
MCTR18.00XM25A-10	18	25	192.2	56	232	TOHT08...	GP05-075, GP05-18-075-DC
MCTR18.24XU25.4-10	18.24	25.4	193	56	232	TOHT09..	GP06-085, GP06-20-085-DC
MCTR18.64XU25.4-10	18.64	25.4	193	56	232	TOHT09..	GP06-085, GP06-20-085-DC
MCTR19.00XM25-10	19	25	203	56	243	TOHT09...	GP06-085, GP06-20-085-DC
MCTR19.05XU25.4-10	19.05	25.4	203	56	243	TOHT09..	GP06-085, GP06-20-085-DC
MCTR19.94XU31.75-10	19.94	31.75	213	60	255	TOHT09..	GP06-085, GP06-20-085-DC
MCTR20.00XM32-10	20	32	213	60	255	TOHT09...	GP06-085, GP06-20-085-DC
MCTR20.62XU31.75-10	20.62	31.75	213.2	60	255	TOHT10..	GP06-085, GP06-20-085-DC
MCTR21.00XM32-10	21	32	223.2	60	266	TOHT10...	GP06-085, GP06-20-085-DC
MCTR22.00XM32-10	22	32	233.4	60	278	TOHT11...	GP06-100, GP06-20-100-DC
MCTR22.23XU31.75-10	22.23	31.75	233.4	60	278	TOHT11..	GP06-100, GP06-20-100-DC
MCTR23.00XM32-10	23	32	243.4	60	289	TOHT11...	GP06-100, GP06-20-100-DC
MCTR23.80XU31.75-10	23.8	31.75	253.4	60	301	TOHT11..	GP06-100, GP06-20-100-DC
MCTR24.00XM32-10	24	32	253.4	60	301	TOHT11...	GP06-100, GP06-20-100-DC
MCTR25.00XM32-10	25	32	263.4	60	312	TOHT11...	GP06-100, GP06-20-100-DC
MCTR25.40XU31.75-10	25.4	31.75	263.7	60	312	TOHT12..	GP06, GP06-20-120-DC
MCTR26.00XM40-10	26	40	273.7	70	324	TOHT12...	GP06, GP06-20-120-DC
MCTR26.97XU31.75X-10	26.97	31.75	283.7	60	335	TOHT12..	GP06, GP06-20-120-DC
MCTR27.00XM40-10	27	40	283.7	70	335	TOHT12...	GP06, GP06-20-120-DC
MCTR28.00XM40-10	28	40	283.7	70	337	TOHT12...	GP06, GP06-20-120-DC

DC	Tool diameter tolerance	Applicable tolerance range of hole diameter
16 - 28	0 / - 0.07	+ 0.05 / - 0.1

Reference pages: Inserts, Guide pads → **J107 - J110**, Standard cutting conditions → **J112**

MCTR-F L/D=10

Indexable gun drill, L/D = 10, for lathes and machining centers

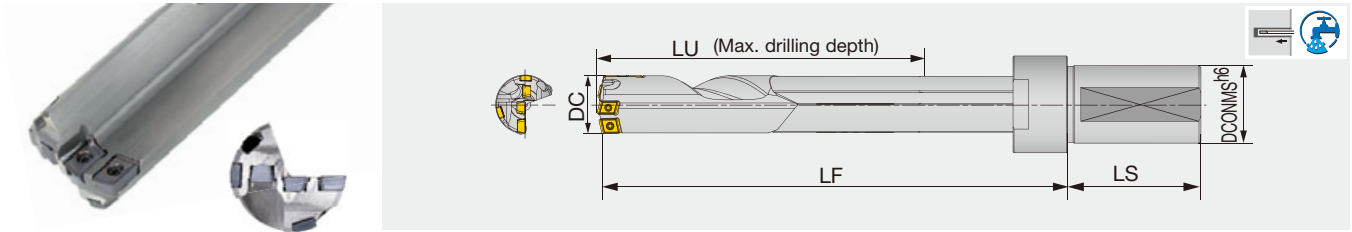

Designation	DC	DCONMS	LU	LS	LF	Insert	Guide pad
MCTR28.58XFU31.75-10	28.58	31.75	292.6	69	360	FBM07**-C, FBM06**-I, FBH06**-P	GP06, GP06-20-120-DC
MCTR29.00XFM40-10	29	40	292.6	69	360	FBM07**-C, FBM06**-I, FBH06**-P	GP06, GP06-20-120-DC
MCTR30.00XFM40-10	30	40	312.9	69	383	FBM07**-C, FBM07**-I, FBH08**-P	GP06, GP06-20-120-DC
MCTR31.00XFM40-10	31	40	312.9	69	383	FBM07**-C, FBM07**-I, FBH08**-P	GP06, GP06-20-120-DC
MCTR31.75XFU31.75-10	31.75	31.75	323	69	395	FBM07**-C, FBM07**-I, FBH08**-P	GP06, GP06-20-120-DC
MCTR32.00XFM40-10	32	40	323	69	395	FBM07**-C, FBM07**-I, FBH08**-P	GP06, GP06-20-120-DC
MCTR33.00XFM40-10	33	40	333.1	69	406	FBM07**-C, FBM07**-I, FBH08**-P	GP06, GP06-20-120-DC
MCTR34.00XFM40-10	34	40	343	69	418	FBM07**-C, FBM07**-I, FBH08**-P	GP07, GP07-20-120-DC
MCTR34.93XFU31.75-10	34.93	31.75	353.1	69	428	FBM07**-C, FBM07**-I, FBH08**-P	GP07, GP07-20-120-DC
MCTR35.00XFM40-10	35	40	353.1	69	428	FBM07**-C, FBM07**-I, FBH08**-P	GP07, GP07-20-120-DC
MCTR36.00XFM40-10	36	40	363.1	69	441	FBM08**-C, FBM07**-I, FBH08**-P	GP07, GP07-20-120-DC
MCTR37.00XFM40-10	37	40	373	69	451	FBM08**-C, FBM07**-I, FBH08**-P	GP07, GP07-20-120-DC
MCTR38.00XFM40-10	38	40	383.1	69	464	FBM08**-C, FBM07**-I, FBH08**-P	GP07, GP07-20-120-DC
MCTR38.10XFU31.75-10	38.1	31.75	393.4	69	474	FBM08**-C, FBM07**-I, FBH09**-P	GP08, GP08-25-155-DC
MCTR39.00XFM40-10	39	40	393.4	69	474	FBM08**-C, FBM07**-I, FBH09**-P	GP08, GP08-25-155-DC
MCTR40.00XFM40-10	40	40	403.3	69	487	FBM08**-C, FBM07**-I, FBH09**-P	GP08, GP08-25-155-DC

DC	Tool diameter tolerance	Applicable tolerance range of hole diameter
28.58 - 40	0 / - 0.07	+ 0.05 / - 0.1

Caution:
The drill pipe is blackened to increase the resistance to corrosion, and the finished surface may appear uneven. This, however, will not affect the performance of the drill.

Reference pages: Inserts, Guide pads → **J108 - J110**, Standard cutting conditions → **J112**



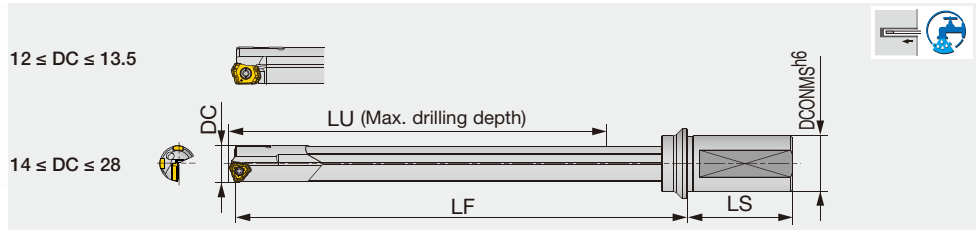

Designation	DC	DCONMS	LU	LS	LF	Insert	Guide pad
MCTR12.00XM20-15	12	20	196.8	50	225	LOGT06...	GP04-055, GP04-16-055-DC
MCTR12.50XM20-15	12.5	20	196.8	50	226	LOGT06...	GP04-055, GP04-16-055-DC
MCTR12.70XU25.4-15	12.7	25.4	196.8	56	229	LOGT06...	GP04-055, GP04-16-055-DC
MCTR13.00XM25-15	13	25	211.8	56	245	LOGT06...	GP04-055, GP04-16-055-DC
MCTR13.49XU25.4-15	13.49	25.4	211.8	56	245	LOGT06..	GP04-055, GP04-16-055-DC
MCTR13.50XM25-15	13.5	25	211.8	56	245	LOGT06...	GP04-055, GP04-16-055-DC
MCTR14.00XM25-15	14	25	227	56	245	TOHT07...	GP05-060, GP05-18-060-DC
MCTR14.27XU25.4-15	14.27	25.4	227	56	261	TOHT07..	GP05-060, GP05-18-060-DC
MCTR14.50XM25-15	14.5	25	227	56	262	TOHT07...	GP05-060, GP05-18-060-DC
MCTR15.00XM25-15	15	25	242	56	278	TOHT07...	GP05-060, GP05-18-060-DC
MCTR15.88XU25.4-15	15.88	25.4	242	56	279	TOHT07..	GP05-060, GP05-18-060-DC
MCTR16.00XM25A-15	16	25	257.2	56	294	TOHT08...	GP05-075, GP05-18-075-DC
MCTR16.50XM25A-15	16.5	25	257.2	56	294	TOHT08...	GP05-075, GP05-18-075-DC
MCTR17.00XM25A-15	17	25	272.2	56	310	TOHT08...	GP05-075, GP05-18-075-DC
MCTR17.45XU25.4A-15	17.45	25.4	272.2	56	310	TOHT08..	GP05-075, GP05-18-075-DC
MCTR17.50XM25A-15	17.5	25	272.2	56	310	TOHT08...	GP05-075, GP05-18-075-DC
MCTR18.00XM25A-15	18	25	287.2	56	327	TOHT08...	GP05-075, GP05-18-075-DC
MCTR18.24XU25.4-15	18.24	25.4	288	56	327	TOHT09..	GP06-085, GP06-20-085-DC
MCTR18.50XM25-15	18.5	25	288	56	327	TOHT09...	GP06-085, GP06-20-085-DC
MCTR18.64XU25.4-15	18.64	25.4	288	56	327	TOHT09..	GP06-085, GP06-20-085-DC
MCTR19.00XM25-15	19	25	303	56	343	TOHT09...	GP06-085, GP06-20-085-DC
MCTR19.05XU25.4-15	19.05	25.4	303	56	343	TOHT09..	GP06-085, GP06-20-085-DC
MCTR19.50XM25-15	19.5	25	303	56	343	TOHT09...	GP06-085, GP06-20-085-DC
MCTR19.94XU31.75-15	19.94	31.75	318	60	360	TOHT09..	GP06-085, GP06-20-085-DC
MCTR20.00XM32-15	20	32	318	60	360	TOHT09...	GP06-085, GP06-20-085-DC
MCTR20.62XU31.75-15	20.62	31.75	318.2	60	360	TOHT10..	GP06-085, GP06-20-085-DC
MCTR21.00XM32-15	21	32	333.2	60	376	TOHT10...	GP06-085, GP06-20-085-DC
MCTR22.00XM32-15	22	32	348.4	60	393	TOHT11...	GP06-100, GP06-20-100-DC
MCTR22.23XU31.75-15	22.23	31.75	348.4	60	393	TOHT11..	GP06-100, GP06-20-100-DC
MCTR23.00XM32-15	23	32	363.4	60	409	TOHT11...	GP06-100, GP06-20-100-DC
MCTR23.80XU31.75-15	23.8	31.75	378.4	60	426	TOHT11..	GP06-100, GP06-20-100-DC
MCTR24.00XM32-15	24	32	378.4	60	426	TOHT11...	GP06-100, GP06-20-100-DC
MCTR25.00XM32-15	25	32	393.4	60	442	TOHT11...	GP06-100, GP06-20-100-DC
MCTR25.40XU31.75-15	25.4	31.75	393.7	60	442	TOHT12..	GP06, GP06-20-120-DC
MCTR26.00XM40-15	26	40	408.7	70	459	TOHT12...	GP06, GP06-20-120-DC
MCTR26.97XU31.75X-15	26.97	31.75	423.7	60	475	TOHT12..	GP06, GP06-20-120-DC
MCTR27.00XM40-15	27	40	423.7	70	475	TOHT12...	GP06, GP06-20-120-DC
MCTR28.00XM40-15	28	40	423.7	70	477	TOHT12...	GP06, GP06-20-120-DC

DC	Tool diameter tolerance	Applicable tolerance range of hole diameter
12 - 13.99	0 / - 0.08	+ 0.05 / - 0.11
14 - 28	0 / - 0.07	+ 0.05 / - 0.1

MCTR-F L/D=15

Indexable gun drill, L/D = 15, for lathes and machining centers

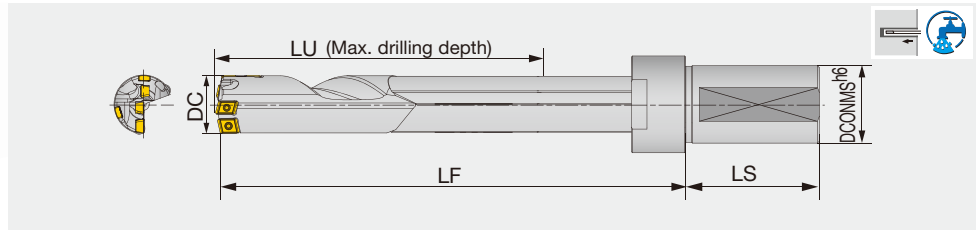

Designation	DC	DCONMS	LU	LS	LF	Insert	Guide pad
MCTR28.58XFU31.75-15	28.58	31.75	437.6	69	505	FBM07**-C, FBM06**-I, FBH06**-P	GP06, GP06-20-120-DC
MCTR29.00XFM40-15	29	40	437.6	69	505	FBM07**-C, FBM06**-I, FBH06**-P	GP06, GP06-20-120-DC
MCTR30.00XFM40-15	30	40	467.9	69	538	FBM07**-C, FBM07**-I, FBH08**-P	GP06, GP06-20-120-DC
MCTR31.00XFM40-15	31	40	467.9	69	538	FBM07**-C, FBM07**-I, FBH08**-P	GP06, GP06-20-120-DC
MCTR31.75XFU31.75-15	31.75	31.75	483	69	555	FBM07**-C, FBM07**-I, FBH08**-P	GP06, GP06-20-120-DC
MCTR32.00XFM40-15	32	40	483	69	555	FBM07**-C, FBM07**-I, FBH08**-P	GP06, GP06-20-120-DC
MCTR33.00XFM40-15	33	40	498.1	69	571	FBM07**-C, FBM07**-I, FBH08**-P	GP06, GP06-20-120-DC
MCTR34.00XFM40-15	34	40	513	69	588	FBM07**-C, FBM07**-I, FBH08**-P	GP07, GP07-20-120-DC
MCTR34.93XFU31.75-15	34.93	31.75	528.1	69	603	FBM07**-C, FBM07**-I, FBH08**-P	GP07, GP07-20-120-DC
MCTR35.00XFM40-15	35	40	528.1	69	603	FBM07**-C, FBM07**-I, FBH08**-P	GP07, GP07-20-120-DC
MCTR36.00XFM40-15	36	40	543.1	69	621	FBM08**-C, FBM07**-I, FBH08**-P	GP07, GP07-20-120-DC
MCTR37.00XFM40-15	37	40	558	69	636	FBM08**-C, FBM07**-I, FBH08**-P	GP07, GP07-20-120-DC
MCTR38.00XFM40-15	38	40	573.1	69	654	FBM08**-C, FBM07**-I, FBH08**-P	GP07, GP07-20-120-DC
MCTR38.10XFU31.75-15	38.1	31.75	588.4	69	669	FBM08**-C, FBM07**-I, FBH09**-P	GP08, GP08-25-155-DC
MCTR39.00XFM40-15	39	40	588.4	69	669	FBM08**-C, FBM07**-I, FBH09**-P	GP08, GP08-25-155-DC
MCTR40.00XFM40-15	40	40	603.3	69	687	FBM08**-C, FBM07**-I, FBH09**-P	GP08, GP08-25-155-DC

DC	Tool diameter tolerance	Applicable tolerance range of hole diameter
28.58 - 40	0 / - 0.07	+ 0.05 / - 0.1

Caution:

The drill pipe is blackened to increase the resistance to corrosion, and the finished surface may appear uneven. This, however, will not affect the performance of the drill.

MCTR L/D=20

Indexable gun drill, L/D = 20, for lathes and machining centers

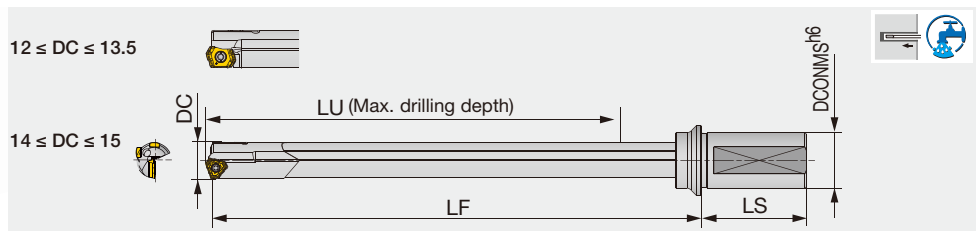

Designation	DC	DCONMS	LU	LS	LF	Insert	Guide pad
MCTR12.00XM20-20	12	20	261.8	50	290	LOGT06...	GP04-055, GP04-16-055-DC
MCTR12.50XM20-20	12.5	20	261.8	50	291	LOGT06...	GP04-055, GP04-16-055-DC
MCTR13.00XM25-20	13	25	281.8	56	315	LOGT06...	GP04-055, GP04-16-055-DC
MCTR13.50XM25-20	13.5	25	281.8	56	315	LOGT06...	GP04-055, GP04-16-055-DC
MCTR14.00XM25-20	14	25	302	56	336	TOHT07...	GP05-060, GP05-18-060-DC
MCTR14.50XM25-20	14.5	25	302	56	337	TOHT07...	GP05-060, GP05-18-060-DC
MCTR15.00XM25-20	15	25	322	56	358	TOHT07...	GP05-060, GP05-18-060-DC

DC	Tool diameter tolerance	Applicable tolerance range of hole diameter
12 - 13.99	0 / - 0.08	+ 0.05 / - 0.11
14 - 15	0 / - 0.07	+ 0.05 / - 0.1

Reference pages: Inserts, Guide pads → **J107 - J110**, Standard cutting conditions → **J112**

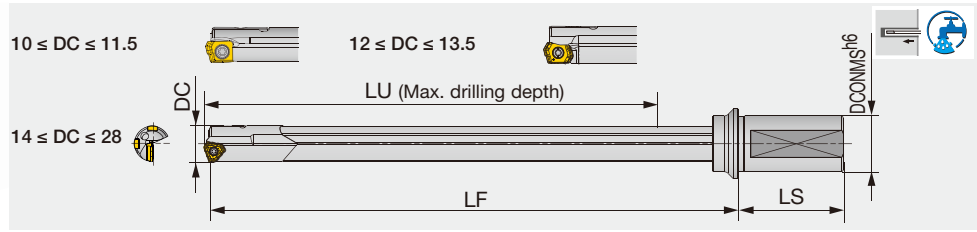

Designation	DC	DCONMS	LU	LS	LF	Insert	Guide pad
MCTR10.00XM20-25	10	20	264.2	50	289.5	ZSGT06...	GP04-16-045-DC
MCTR11.00XM20-25	11	20	301.7	50	329	ZSGT06...	GP04-16-050-DC
MCTR11.50XM20-25	11.5	20	301.7	50	329	ZSGT06...	GP04-16-050-DC
MCTR12.00XM20-25	12	20	326.8	50	355	LOGT06...	GP04-055, GP04-16-055-DC
MCTR12.50XM20-25	12.5	20	326.8	50	356	LOGT06...	GP04-055, GP04-16-055-DC
MCTR12.70XU25.4-25	12.7	25.4	326.8	56	359	LOGT06...	GP04-055, GP04-16-055-DC
MCTR13.00XM25-25	13	25	351.8	56	385	LOGT06...	GP04-055, GP04-16-055-DC
MCTR13.49XU25.4-25	13.49	25.4	351.8	56	385	LOGT06...	GP04-055, GP04-16-055-DC
MCTR13.50XM25-25	13.5	25	351.8	56	385	LOGT06...	GP04-055, GP04-16-055-DC
MCTR14.00XM25-25	14	25	377	56	411	TOHT07...	GP05-060, GP05-18-060-DC
MCTR14.27XU25.4-25	14.27	25.4	377	56	411	TOHT07...	GP05-060, GP05-18-060-DC
MCTR14.50XM25-25	14.5	25	377	56	412	TOHT07...	GP05-060, GP05-18-060-DC
MCTR15.00XM25-25	15	25	402	56	438	TOHT07...	GP05-060, GP05-18-060-DC
MCTR15.88XU25.4-25	15.88	25.4	402	56	439	TOHT07...	GP05-060, GP05-18-060-DC
MCTR16.00XM25A-25	16	25	427.2	56	464	TOHT08...	GP05-075, GP05-18-075-DC
MCTR16.50XM25A-25	16.5	25	427.2	56	464	TOHT08...	GP05-075, GP05-18-075-DC
MCTR17.00XM25A-25	17	25	452.2	56	490	TOHT08...	GP05-075, GP05-18-075-DC
MCTR17.45XU25.4A-25	17.45	25.4	452.2	56	490	TOHT08...	GP05-075, GP05-18-075-DC
MCTR17.50XM25A-25	17.5	25	452.2	56	490	TOHT08...	GP05-075, GP05-18-075-DC
MCTR18.00XM25A-25	18	25	477.2	56	517	TOHT08...	GP05-075, GP05-18-075-DC
MCTR18.24XU25.4-25	18.24	25.4	478	56	517	TOHT09...	GP06-085, GP06-20-085-DC
MCTR18.50XM25-25	18.5	25	478	56	517	TOHT09...	GP06-085, GP06-20-085-DC
MCTR18.64XU25.4-25	18.64	25.4	478	56	517	TOHT09...	GP06-085, GP06-20-085-DC
MCTR19.00XM25-25	19	25	503	56	543	TOHT09...	GP06-085, GP06-20-085-DC
MCTR19.05XU25.4-25	19.05	25.4	503	56	543	TOHT09...	GP06-085, GP06-20-085-DC
MCTR19.50XM25-25	19.5	25	503	56	543	TOHT09...	GP06-085, GP06-20-085-DC
MCTR19.94XU31.75-25	19.94	31.75	528	60	570	TOHT09...	GP06-085, GP06-20-085-DC
MCTR20.00XM32-25	20	32	528	60	570	TOHT09...	GP06-085, GP06-20-085-DC
MCTR20.62XU31.75-25	20.62	31.75	528.2	60	570	TOHT10...	GP06-085, GP06-20-085-DC
MCTR21.00XM32-25	21	32	553.2	60	596	TOHT10...	GP06-085, GP06-20-085-DC
MCTR22.00XM32-25	22	32	578.4	60	623	TOHT11...	GP06-100, GP06-20-100-DC
MCTR22.23XU31.75-25	22.23	31.75	578.4	60	623	TOHT11...	GP06-100, GP06-20-100-DC
MCTR23.00XM32-25	23	32	603.4	60	649	TOHT11...	GP06-100, GP06-20-100-DC
MCTR23.80XU31.75-25	23.8	31.75	628.4	60	676	TOHT11...	GP06-100, GP06-20-100-DC
MCTR24.00XM32-25	24	32	628.4	60	676	TOHT11...	GP06-100, GP06-20-100-DC
MCTR25.00XM32-25	25	32	653.4	60	702	TOHT11...	GP06-100, GP06-20-100-DC
MCTR25.40XU31.75-25	25.4	31.75	653.7	60	702	TOHT12...	GP06, GP06-20-120-DC
MCTR26.00XM40-25	26	40	678.7	70	729	TOHT12...	GP06, GP06-20-120-DC
MCTR26.97XU31.75X-25	26.97	31.75	703.7	60	755	TOHT12...	GP06, GP06-20-120-DC
MCTR27.00XM40-25	27	40	703.7	70	755	TOHT12...	GP06, GP06-20-120-DC
MCTR28.00XM40-25	28	40	703.7	70	757	TOHT12...	GP06, GP06-20-120-DC

DC	Tool diameter tolerance	Applicable tolerance range of hole diameter
10 - 13.99	0 / - 0.08	+ 0.05 / - 0.11
14 - 28	0 / - 0.07	+ 0.05 / - 0.1

MCTR-F L/D=25

Indexable gun drill, L/D = 25, for lathes and machining centers

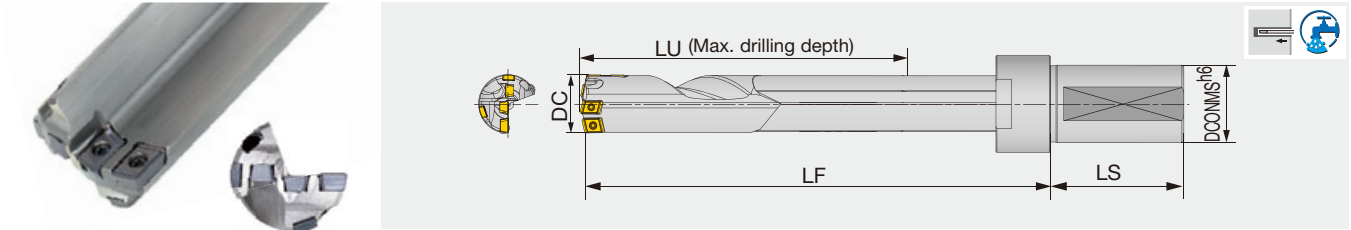

Designation	DC	DCONMS	LU	LS	LF	Insert	Guide pad
MCTR28.58XFU31.75-25	28.58	31.75	727.6	69	795	FBM07**-C, FBM06**-I, FBH06**-P	GP06, GP06-20-120-DC
MCTR30.00XFM40-25	30	40	777.9	69	848	FBM07**-C, FBM07**-I, FBH08**-P	GP06, GP06-20-120-DC
MCTR31.75XFU31.75-25	31.75	31.75	803	69	875	FBM07**-C, FBM07**-I, FBH08**-P	GP06, GP06-20-120-DC
MCTR34.93XFU31.75-25	34.93	31.75	878.1	69	953	FBM07**-C, FBM07**-I, FBH08**-P	GP07, GP07-20-120-DC
MCTR38.10XFU31.75-25	38.1	31.75	978.4	69	1059	FBM08**-C, FBM07**-I, FBH09**-P	GP08, GP08-25-155-DC

DC	Tool diameter tolerance	Applicable tolerance range of hole diameter
28.58 - 38.1	0 / - 0.07	+ 0.05 / - 0.1

Caution:
The drill pipe is blackened to increase the resistance to corrosion, and the finished surface may appear uneven. This, however, will not affect the performance of the drill.

SPARE PARTS

Designation	Insert						Guide pad	
	Central		Intermediate		Peripheral		Screw	Wrench
	Screw	Wrench	Screw	Wrench	Screw	Wrench		
MCTR28.58... - MCTR29...	CSTB-2.5	T-8F	CSTB-2.2	T-7F	CSTB-2.2	T-7F	SR34-508	T-7F
MCTR30... - MCTR33...	CSTB-2.5	T-8F	CSTB-2.5	T-8F	CSTB-2.5	T-8F	SR34-508	T-7F
MCTR33.1... - MCTR40...	CSTB-2.5	T-8F	CSTB-2.5	T-8F	CSTB-2.5	T-8F	CSTB-3S	T-9F

Recommended torque (N·m) for clamping: CSTB-2.5=1.3, CSTB-2.2=1, SR34-508=0.9, CSTB-3S=2.3

MCTRCH L/D=25

Indexable gun drill, L/D = 25, for drilling cross hole applications on CNC lathes and machining centers

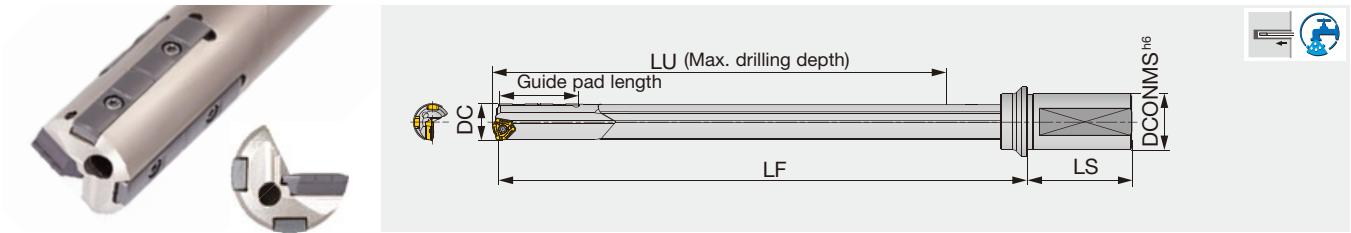

Designation	DC	DCONMS	LU	LS	LF	Insert	Guide pad	Guide pad length
MCTRCH14.00XM25-25	14	25	377	56	411	TOHT07...	GP05-060, GP05-18-060-DC	36
MCTRCH14.68XU25.4-25	14.68	25.4	377	56	412	TOHT07...	GP05-060, GP05-18-060-DC	36
MCTRCH15.00XM25-25	15	25	402	56	438	TOHT07...	GP05-060, GP05-18-060-DC	36
MCTRCH15.06XU25.4-25	15.06	25.4	402	56	438	TOHT07...	GP05-060, GP05-18-060-DC	36
MCTRCH16.00XM25A-25	16	25	427.2	56	464	TOHT08...	GP05-075, GP05-18-075-DC	36
MCTRCH18.00XM25A-25	18	25	477.2	56	517	TOHT08...	GP05-075, GP05-18-075-DC	36
MCTRCH18.24XU25.4-25	18.24	25.4	478	56	517	TOHT09...	GP06-085, GP06-20-085-DC	40
MCTRCH18.64XU25.4-25	18.64	25.4	478	56	517	TOHT09...	GP06-085, GP06-20-085-DC	40
MCTRCH19.00XM25-25	19	25	503	56	543	TOHT09...	GP06-085, GP06-20-085-DC	40
MCTRCH20.00XM32-25	20	32	528	60	570	TOHT09...	GP06-085, GP06-20-085-DC	40
MCTRCH23.00XM32-25	23	32	603.4	60	649	TOHT11...	GP06-100, GP06-20-100-DC	40
MCTRCH23.80XU31.75-25	23.8	31.75	628.4	60	676	TOHT11...	GP06-100, GP06-20-100-DC	40
MCTRCH24.00XM32-25	24	32	628.4	60	676	TOHT11...	GP06-100, GP06-20-100-DC	40
MCTRCH28.00XM40-25	28	40	703.7	70	757	TOHT12...	GP06, GP06-20-120-DC	40

DC	Tool diameter tolerance	Applicable tolerance range of hole diameter
14 - 28	0 / - 0.09	+ 0.05 / - 0.12

SPARE PARTS

Designation	Insert		Guide pad	
	Screw	Wrench	Screw	Wrench
MCTRCH14... - MCTRCH20...	SR14-560/S	T-8F	SR34-508	T-7F
MCTRCH23... - MCTRCH24...	SR14-571/S	T-10/5	SR34-508	T-7F
MCTRCH28...	SR14-506	T-15F	SR34-508	T-7F

Recommended torque (N·m) for clamping: SR34-508=0.9, SR14-560/S=1.2, SR14-571/S=3.2, SR14-506=4.8

Reference pages: Inserts, Guide pads → **J107 - J110**, Standard cutting conditions → **J112**

■ Tool selection with regard to cross hole diameters and drill diameters

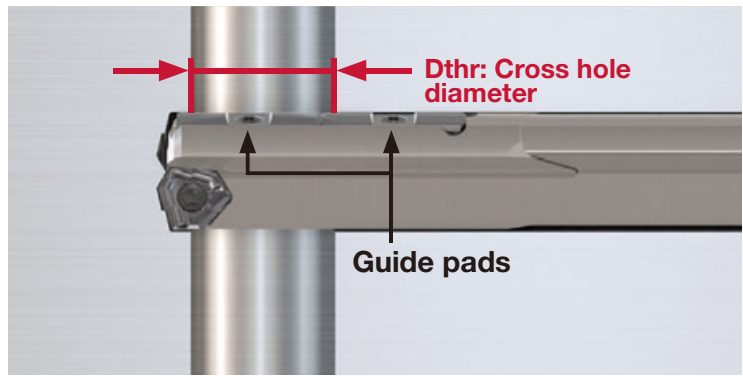
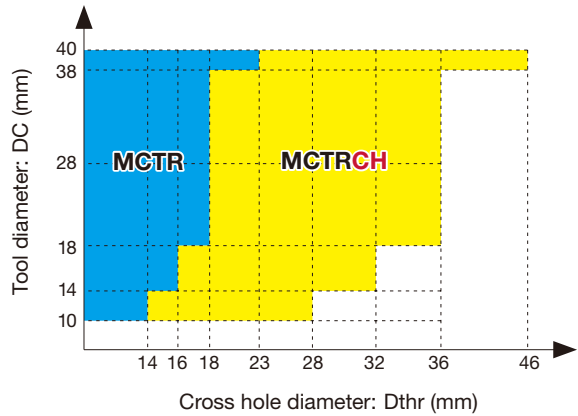

Note: An MCTR drill can be used when the cross hole diameter (Dthr) is smaller than the drill's guide pad length. When the cross hole diameter is larger than the drill's guide pad length, use an MCTRCH drill.

DEEPT^{RI} DRILL

MCTR L/D=35, 40, 45

Indexable gun drill, L/D = 35, 40, 45, for lathes and machining centers

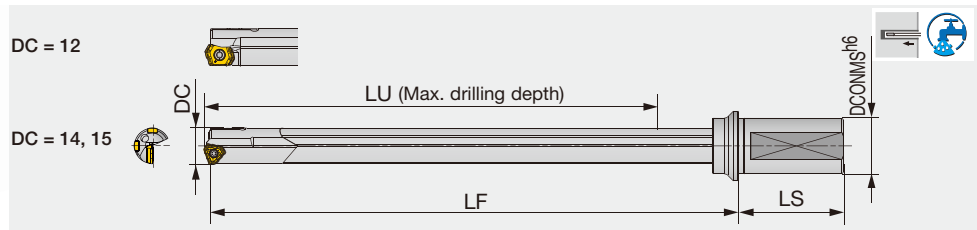

Designation	DC	L/D	DCONMS	LU	LS	LF	Insert	Guide pad
MCTR12.00XM20-35	12	35	20	456.8	50	485	LOGT06...	GP04-055, GP04-16-055-DC
MCTR12.00XM20-40	12	40	20	521.8	50	550	LOGT06...	GP04-055, GP04-16-055-DC
MCTR12.00XM20-45	12	45	20	586.8	50	615	LOGT06...	GP04-055, GP04-16-055-DC
MCTR14.00XM25-35	14	35	25	527	56	561	TOHT07...	GP05-060, GP05-18-060-DC
MCTR14.00XM25-40	14	40	25	602	56	636	TOHT07..	GP05-060, GP05-18-060-DC
MCTR15.00XM25-35	15	35	25	562	56	598	TOHT07...	GP05-060, GP05-18-060-DC
MCTR15.00XM25-40	15	40	25	642	56	678	TOHT07...	GP05-060, GP05-18-060-DC

DC	Tool diameter tolerance	Applicable tolerance range of hole diameter
12 - 13.99	0 / - 0.08	+ 0.05 / - 0.11
14 - 15	0 / - 0.07	+ 0.05 / - 0.1

SPARE PARTS

Designation	Insert		Guide pad	
	Screw	Wrench	Screw	Wrench
MCTR10... - MCTR11.5...	SR-M2.5X0.35L3.8	T-7F	CSTB-2	T-6F
MCTR12... - MCTR13.5...	SR10503833L040	T-7F	CSPB-2L043	IP-6F
MCTR14... - MCTR20...	SR14-560/S	T-8F	SR34-508	T-7F
MCTR20.62... - MCTR21...	SR34-506	T-9F	SR34-508	T-7F
MCTR22... - MCTR25...	SR14-571/S	T-10/5	SR34-508	T-7F
MCTR25.4... - MCTR28...	SR14-506	T-15F	SR34-508	T-7F

Recommended torque (N·m) for clamping: SR-M2.5X0.35L3.8=0.9, CSTB-2=0.7, SR10503833L040=1.3, CSPB-2L043=0.7, SR14-560/S=1.2, SR34-508=0.9, SR34-506=0.9, SR14-571/S=3.2, SR14-506=4.8

Reference pages: Inserts, Guide pads → **J107 - J110**, Standard cutting conditions → **J112**

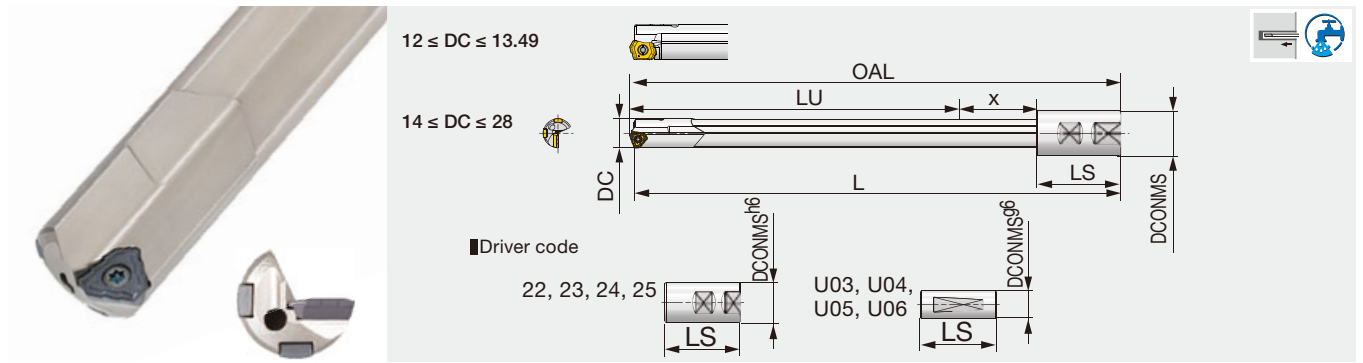

Designation	DC	L	DCONMS	LU	OAL	LS	x	Driver code	Insert	Guide pad
TRLG12.00X800-U03	12	800	19.05	713.8	801.8	70	18	U03	LOGT06...	GP04-055, GP04-16-055-DC
TRLG12.00X800-22	12	800	20	733.8	801.8	50	18	22	LOGT06...	GP04-055, GP04-16-055-DC
TRLG12.00X1000-U03	12	1000	19.05	913.8	1001.8	70	18	U03	LOGT06...	GP04-055, GP04-16-055-DC
TRLG12.00X1000-22	12	1000	20	933.8	1001.8	50	18	22	LOGT06...	GP04-055, GP04-16-055-DC
TRLG12.00X1650-U03	12	1650	19.05	1563.8	1651.8	70	18	U03	LOGT06...	GP04-055, GP04-16-055-DC
TRLG12.00X1650-22	12	1650	20	1583.8	1651.8	50	18	22	LOGT06...	GP04-055, GP04-16-055-DC
TRLG12.70X1219-U04	12.7	1219	25.4	1131.8	1220.8	70	19	U04	LOGT06..	GP04-055, GP04-16-055-DC
TRLG12.70X1524-U04	12.7	1524	25.4	1436.8	1525.8	70	19	U04	LOGT06..	GP04-055, GP04-16-055-DC
TRLG13.00X800-U04	13	800	25.4	711.8	801.8	70	20	U04	LOGT06...	GP04-055, GP04-16-055-DC
TRLG13.00X800-23	13	800	25	725.8	801.8	56	20	23	LOGT06...	GP04-055, GP04-16-055-DC
TRLG13.00X1000-U04	13	1000	25.4	911.8	1001.8	70	20	U04	LOGT06...	GP04-055, GP04-16-055-DC
TRLG13.00X1000-23	13	1000	25	925.8	1001.8	56	20	23	LOGT06...	GP04-055, GP04-16-055-DC
TRLG13.00X1650-U04	13	1650	25.4	1561.8	1651.8	70	20	U04	LOGT06...	GP04-055, GP04-16-055-DC
TRLG13.00X1650-23	13	1650	25	1575.8	1651.8	56	20	23	LOGT06...	GP04-055, GP04-16-055-DC
TRLG13.49X1219-U04	13.49	1219	25.4	1130.8	1220.8	70	20	U04	LOGT06..	GP04-055, GP04-16-055-DC
TRLG13.49X1527-U04	13.49	1527	25.4	1438.8	1528.8	70	20	U04	LOGT06..	GP04-055, GP04-16-055-DC
TRLG14.00X800-23	14	800	25	725	802	56	21	23	TOHT07...	GP05-060, GP05-18-060-DC
TRLG14.00X800-U04	14	800	25.4	711	802	70	21	U04	TOHT07...	GP05-060, GP05-18-060-DC
TRLG14.00X1000-23	14	1000	25	925	1002	56	21	23	TOHT07...	GP05-060, GP05-18-060-DC
TRLG14.00X1000-U04	14	1000	25.4	911	1002	70	21	U04	TOHT07...	GP05-060, GP05-18-060-DC
TRLG14.00X1650-23	14	1650	25	1575	1652	56	21	23	TOHT07...	GP05-060, GP05-18-060-DC
TRLG14.00X1650-U04	14	1650	25.4	1561	1652	70	21	U04	TOHT07...	GP05-060, GP05-18-060-DC
TRLG14.50X800-23	14.5	800	25	724	802	56	22	23	TOHT07...	GP05-060, GP05-18-060-DC
TRLG14.50X800-U04	14.5	800	25.4	710	802	70	22	U04	TOHT07...	GP05-060, GP05-18-060-DC
TRLG14.50X1000-23	14.5	1000	25	924	1002	56	22	23	TOHT07...	GP05-060, GP05-18-060-DC
TRLG14.50X1000-U04	14.5	1000	25.4	910	1002	70	22	U04	TOHT07...	GP05-060, GP05-18-060-DC
TRLG14.50X1650-23	14.5	1650	25	1574	1652	56	22	23	TOHT07...	GP05-060, GP05-18-060-DC
TRLG14.50X1650-U04	14.5	1650	25.4	1560	1652	70	22	U04	TOHT07...	GP05-060, GP05-18-060-DC
TRLG15.00X800-23	15	800	25	723	802	56	23	23	TOHT07...	GP05-060, GP05-18-060-DC
TRLG15.00X800-U04	15	800	25.4	709	802	70	23	U04	TOHT07...	GP05-060, GP05-18-060-DC
TRLG15.00X1000-23	15	1000	25	923	1002	56	23	23	TOHT07...	GP05-060, GP05-18-060-DC
TRLG15.00X1000-U04	15	1000	25.4	909	1002	70	23	U04	TOHT07...	GP05-060, GP05-18-060-DC
TRLG15.00X1650-23	15	1650	25	1573	1652	56	23	23	TOHT07...	GP05-060, GP05-18-060-DC
TRLG15.00X1650-U04	15	1650	25.4	1559	1652	70	23	U04	TOHT07...	GP05-060, GP05-18-060-DC
TRLG16.00X800-23A	16	800	25	722.2	802.2	56	24	23	TOHT08...	GP05-075, GP05-18-075-DC
TRLG16.00X800-U04A	16	800	25.4	708.2	802.2	70	24	U04	TOHT08...	GP05-075, GP05-18-075-DC
TRLG16.00X1000-23A	16	1000	25	922.2	1002.2	56	24	23	TOHT08...	GP05-075, GP05-18-075-DC
TRLG16.00X1000-U04A	16	1000	25.4	908.2	1002.2	70	24	U04	TOHT08...	GP05-075, GP05-18-075-DC
TRLG16.00X1500-23A	16	1500	25	1422.2	1502.2	56	24	23	TOHT08...	GP05-075, GP05-18-075-DC
TRLG16.00X1500-U04A	16	1500	25.4	1408.2	1502.2	70	24	U04	TOHT08...	GP05-075, GP05-18-075-DC
TRLG17.00X800-23A	17	800	25	721.2	802.2	56	25	23	TOHT08...	GP05-075, GP05-18-075-DC
TRLG17.00X800-U04A	17	800	25.4	707.2	802.2	70	25	U04	TOHT08...	GP05-075, GP05-18-075-DC
TRLG17.00X1000-23A	17	1000	25	921.2	1002.2	56	25	23	TOHT08...	GP05-075, GP05-18-075-DC
TRLG17.00X1000-U04A	17	1000	25.4	907.2	1002.2	70	25	U04	TOHT08...	GP05-075, GP05-18-075-DC
TRLG18.00X800-23A	18	800	25	719.2	802.2	56	27	23	TOHT08...	GP05-075, GP05-18-075-DC
TRLG18.00X800-U04A	18	800	25.4	705.2	802.2	70	27	U04	TOHT08...	GP05-075, GP05-18-075-DC
TRLG18.00X1000-23A	18	1000	25	919.2	1002.2	56	27	23	TOHT08...	GP05-075, GP05-18-075-DC
TRLG18.00X1000-U04A	18	1000	25.4	905.2	1002.2	70	27	U04	TOHT08...	GP05-075, GP05-18-075-DC
TRLG18.00X1500-23A	18	1500	25	1419.2	1502.2	56	27	23	TOHT08...	GP05-075, GP05-18-075-DC



Designation	DC	L	DCONMS	LU	OAL	LS	x	Driver code	Insert	Guide pad
TRLG18.00X1500-U04A	18	1500	25.4	1405.2	1502.2	70	27	U04	TOHT08...	GP05-075, GP05-18-075-DC
TRLG18.50X1500-23	18.5	1500	25	1420	1503	56	27	23	TOHT09...	GP06-085, GP06-20-085-DC
TRLG18.50X1500-U04	18.5	1500	25.4	1406	1503	70	27	U04	TOHT09...	GP06-085, GP06-20-085-DC
TRLG19.00X800-23	19	800	25	719	803	56	28	23	TOHT09...	GP06-085, GP06-20-085-DC
TRLG19.00X800-U04	19	800	25.4	705	803	70	28	U04	TOHT09...	GP06-085, GP06-20-085-DC
TRLG19.00X1000-23	19	1000	25	919	1003	56	28	23	TOHT09...	GP06-085, GP06-20-085-DC
TRLG19.00X1000-U04	19	1000	25.4	905	1003	70	28	U04	TOHT09...	GP06-085, GP06-20-085-DC
TRLG20.00X800-24	20	800	32	713	803	60	30	24	TOHT09...	GP06-085, GP06-20-085-DC
TRLG20.00X800-U05	20	800	31.75	703	803	70	30	U05	TOHT09...	GP06-085, GP06-20-085-DC
TRLG20.00X1000-24	20	1000	32	913	1003	60	30	24	TOHT09...	GP06-085, GP06-20-085-DC
TRLG20.00X1000-U05	20	1000	31.75	903	1003	70	30	U05	TOHT09...	GP06-085, GP06-20-085-DC
TRLG21.00X1000-24	21	1000	32	912.2	1003.2	60	31	24	TOHT10...	GP06-085, GP06-20-085-DC
TRLG21.00X1000-U05	21	1000	31.75	902.2	1003.2	70	31	U05	TOHT10...	GP06-085, GP06-20-085-DC
TRLG22.00X1000-24	22	1000	32	910.4	1003.4	60	33	24	TOHT11...	GP06-100, GP06-20-100-DC
TRLG22.00X1000-U05	22	1000	31.75	900.4	1003.4	70	33	U05	TOHT11...	GP06-100, GP06-20-100-DC
TRLG22.00X1500-24	22	1500	32	1410.4	1503.4	60	33	24	TOHT11...	GP06-100, GP06-20-100-DC
TRLG22.00X1500-U05	22	1500	31.75	1400.4	1503.4	70	33	U05	TOHT11...	GP06-100, GP06-20-100-DC
TRLG23.00X1000-24	23	1000	32	909.4	1003.4	60	34	24	TOHT11...	GP06-100, GP06-20-100-DC
TRLG23.00X1000-U05	23	1000	31.75	899.4	1003.4	70	34	U05	TOHT11...	GP06-100, GP06-20-100-DC
TRLG23.00X1500-24	23	1500	32	1409.4	1503.4	60	34	24	TOHT11...	GP06-100, GP06-20-100-DC
TRLG23.00X1500-U05	23	1500	31.75	1399.4	1503.4	70	34	U05	TOHT11...	GP06-100, GP06-20-100-DC
TRLG24.00X1000-24	24	1000	32	907.4	1003.4	60	36	24	TOHT11...	GP06-100, GP06-20-100-DC
TRLG24.00X1000-U05	24	1000	31.75	897.4	1003.4	70	36	U05	TOHT11...	GP06-100, GP06-20-100-DC
TRLG24.00X1500-24	24	1500	32	1407.4	1503.4	60	36	24	TOHT11...	GP06-100, GP06-20-100-DC
TRLG24.00X1500-U05	24	1500	31.75	1397.4	1503.4	70	36	U05	TOHT11...	GP06-100, GP06-20-100-DC
TRLG25.00X1000-24	25	1000	32	906.4	1003.4	60	37	24	TOHT11...	GP06-100, GP06-20-100-DC
TRLG25.00X1000-U05	25	1000	31.75	896.4	1003.4	70	37	U05	TOHT11...	GP06-100, GP06-20-100-DC
TRLG26.00X1000-25	26	1000	40	894.7	1003.7	70	39	25	TOHT12...	GP06, GP06-20-120-DC
TRLG26.00X1000-U06	26	1000	38.1	894.7	1003.7	70	39	U06	TOHT12...	GP06, GP06-20-120-DC
TRLG27.00X1000-25	27	1000	40	893.7	1003.7	70	40	25	TOHT12...	GP06, GP06-20-120-DC
TRLG27.00X1000-U06	27	1000	38.1	893.7	1003.7	70	40	U06	TOHT12...	GP06, GP06-20-120-DC
TRLG28.00X1000-25	28	1000	40	891.7	1003.7	70	42	25	TOHT12...	GP06, GP06-20-120-DC
TRLG28.00X1000-U06	28	1000	38.1	891.7	1003.7	70	42	U06	TOHT12...	GP06, GP06-20-120-DC

DC	Tool diameter tolerance	Applicable tolerance range of hole diameter
12 - 13.99	0 / - 0.08	+ 0.05 / - 0.11
14 - 28	0 / - 0.07	+ 0.05 / - 0.1

SPARE PARTS



Designation	Insert		Guide pad	
	Screw	Wrench	Screw	Wrench
TRLG12... - TRLG13...	SR10503833L040	T-7F	CSPB-2L043	IP-6F
TRLG14... - TRLG20...	SR14-560/S	T-8F	SR34-508	T-7F
TRLG21...	SR34-506	T-9F	SR34-508	T-7F
TRLG22... - TRLG25...	SR14-571/S	T-10/5	SR34-508	T-7F
TRLG26... - TRLG28...	SR14-506	T-15F	SR34-508	T-7F

Recommended torque (N·m) for clamping: CSPB-2L043=0.7, SR34-508=0.9, SR34-506=0.9, SR14-560/S=1.2, SR10503833L040=1.3, SR14-571/S=3.2, SR14-506=4.8

Reference pages: Inserts, Guide pads → **J107 - J110**, Standard cutting conditions → **J112**

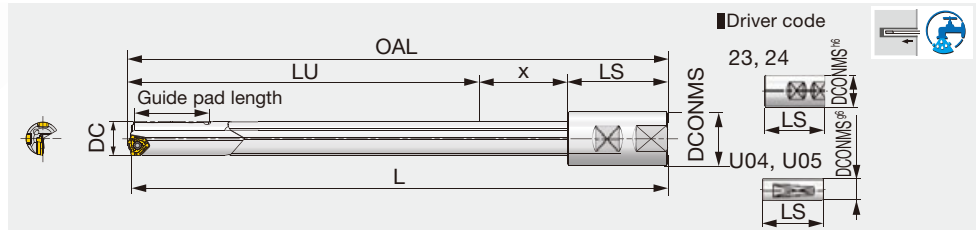

Designation	DC	L	DCONMS	LU	OAL	LS	X	Driver code	Insert	Guide pad	Guide pad length
TRLGCH14.68X1830-U05	14.68	1830	31.75	1740	1832	70	22	U05	TOHT07...	GP05-060, GP05-18-060-DC	36
TRLGCH15.00X1650-U04	15	1650	25.4	1559	1652	70	23	U04	TOHT07...	GP05-060, GP05-18-060-DC	36
TRLGCH15.00X1650-23	15	1650	25	1573	1652	56	23	23	TOHT07...	GP05-060, GP05-18-060-DC	36
TRLGCH15.06X1830-U05	15.06	1830	31.75	1739	1832	70	23	U05	TOHT07...	GP05-060, GP05-18-060-DC	36
TRLGCH18.00X1650-U04A	18	1650	25.4	1555.2	1652.2	70	27	U04	TOHT08...	GP05-075, GP05-18-075-DC	36
TRLGCH18.24X1830-U05	18	1650	25	1569.2	1652.2	56	27	23	TOHT08...	GP05-075, GP05-18-075-DC	36
TRLGCH18.24X1830-U05	18.24	1830	31.75	1736	1833	70	27	U05	TOHT09...	GP06-085, GP06-20-085-DC	40
TRLGCH18.64X1830-U05	18.64	1830	31.75	1736	1833	70	27	U05	TOHT09...	GP06-085, GP06-20-085-DC	40
TRLGCH23.00X1650-U05	23	1650	31.75	1549.4	1653.4	70	34	U05	TOHT11...	GP06-100, GP06-20-100-DC	40
TRLGCH23.00X1650-24	23	1650	32	1559.4	1653.4	60	34	24	TOHT11...	GP06-100, GP06-20-100-DC	40
TRLGCH23.42X1830-U05	23.42	1830	31.75	1729.4	1833.4	70	34	U05	TOHT11...	GP06-100, GP06-20-100-DC	40
TRLGCH23.80X1830-U05	23.8	1830	31.75	1727.4	1833.4	70	36	U05	TOHT11...	GP06-100, GP06-20-100-DC	40
TRLGCH24.00X1650-U05	24	1650	31.75	1547.4	1653.4	70	36	U05	TOHT11...	GP06-100, GP06-20-100-DC	40
TRLGCH24.00X1650-24	24	1650	32	1557.4	1653.4	60	36	24	TOHT11...	GP06-100, GP06-20-100-DC	40

DC	Tool diameter tolerance	Applicable tolerance range of hole diameter
14.68 - 24	0 / - 0.09	+ 0.05 / - 0.12

SPARE PARTS

Designation	Insert		Guide pad	
	Screw	Wrench	Screw	Wrench
TRLGCH14... - TRLGCH18...	SR14-560/S	T-8F	SR34-508	T-7F
TRLGCH23... - TRLGCH24...	SR14-571/S	T-10/5	SR34-508	T-7F

Recommended torque (N·m) for clamping: SR34-508=0.9, SR14-560/S=1.2, SR14-571/S=3.2

■ Tool selection with regard to cross hole diameters and drill diameters

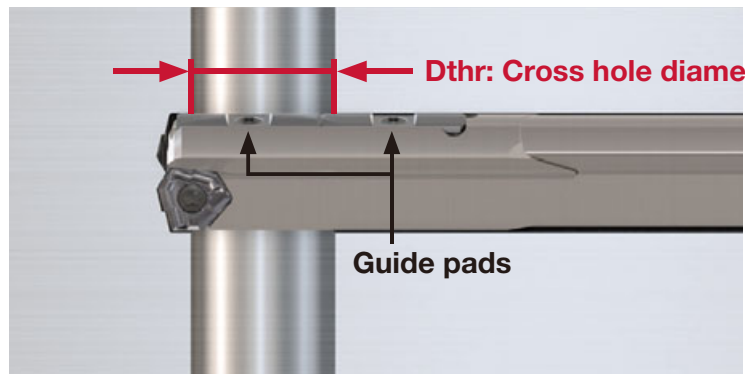
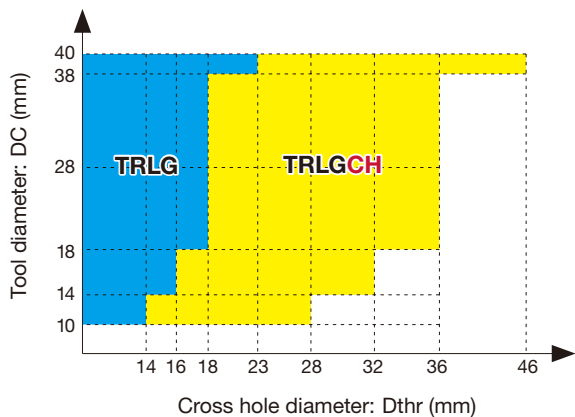

Note: A TRLG drill can be used when the cross hole diameter (Dthr) is smaller than the drill's guide pad length.
When the cross hole diameter is larger than the drill's guide pad length, use an TRLGCH drill.

Indexable gun drill for gun drill machines

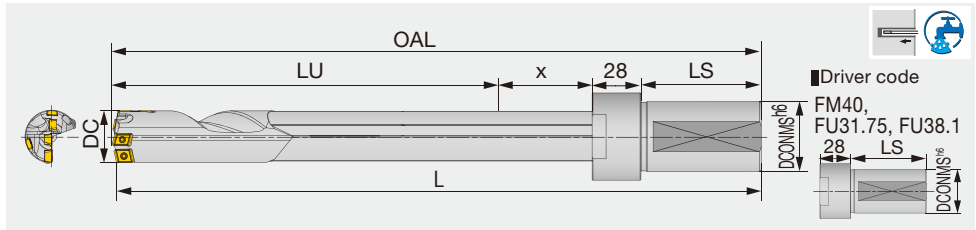

Designation	DC	L	DCONMS	LU	OAL	LS	x	Driver code	Insert	Guide pad
TRLG29.36X1828-FU31.75	29.36	1828	31.75	1689.6	1830.6	69	44	FU31.75	FBM07**-C, FBM06**-I, FBH06**-P	GP06, GP06-20-120-DC
TRLG30.00X1000-FM40	30	1000	40	860.9	1002.9	69	45	FM40	FBM07**-C, FBM07**-I, FBH08**-P	GP06, GP06-20-120-DC
TRLG30.00X1650-FM40	30	1650	40	1510.9	1652.9	69	45	FM40	FBM07**-C, FBM07**-I, FBH08**-P	GP06, GP06-20-120-DC
TRLG30.00X1650-FU38.1	30	1650	38.1	1510.9	1652.9	69	45	FU38.1	FBM07**-C, FBM07**-I, FBH08**-P	GP06, GP06-20-120-DC

DC	Tool diameter tolerance	Applicable tolerance range of hole diameter
29.36, 30	0 / - 0.07	+ 0.05 / - 0.1

Caution:
The drill pipe is blackened to increase the resistance to corrosion, and the finished surface may appear uneven. This, however, will not affect the performance of the drill.

SPARE PARTS



Designation	Insert						Guide pad	
	Central		Intermediate		Peripheral		Screw	Wrench
	Screw	Wrench	Screw	Wrench	Screw	Wrench		
TRLG29.36...	CSTB-2.5	T-8F	CSTB-2.2	T-7F	CSTB-2.2	T-7 F	SR34-508	T-7F
TRLG30...	CSTB-2.5	T-8F	CSTB-2.5	T-8F	CSTB-2.5	T-8F	SR34-508	T-7F

Recommended torque (N·m) for clamping: SR34-508=0.9, CSTB-2.5=1.3

**AVAILABLE RANGE OF TAILOR-MADE DRILL BODIES (FOR LATHES AND MACHINING CENTERS)
MCTR, MCTRCH (FOR DRILLING CROSS HOLE APPLICATIONS)**

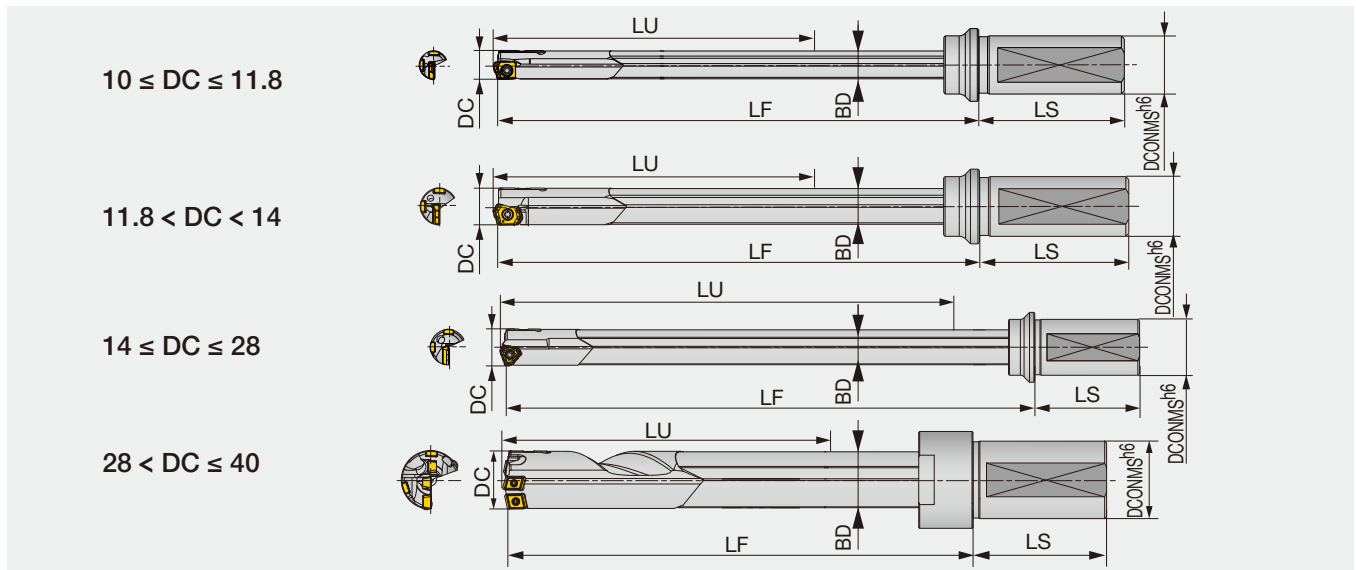

DC	DCONMS	LU	LS	LF	BD	DC	DCONMS	LU	LS	LF	BD
10 - 10.39	20	138 - 526	50	164 - 551	9.6	23.7 - 24.69	32	123 - 1253	60	171 - 1300	23
10.4 - 10.69	20	137 - 551	50	164 - 577	9.9	24.7 - 25.69	32	122 - 1303	60	171 - 1351	24
10.7 - 10.99	20	137 - 551	50	164 - 577	10.2	25.7 - 26.69	40	120 - 1353	70	171 - 1403	25
11 - 11.49	20	136 - 601	50	164 - 628	10.5	26.7 - 27.69	40	119 - 1403	70	171 - 1454	26
11.5 - 11.8	20	136 - 601	50	164 - 628	11	27.7 - 28	40	117 - 1403	70	171 - 1456	27
11.81 - 12.49	20	135 - 651	50	164 - 679	11.5	28.01 - 29	40	154 - 1452	69	222 - 1519	27
12.5 - 12.99	20	134 - 651	50	164 - 680	12	29.01 - 29.99	40	152 - 1502	69	222 - 1571	28
13 - 13.49	25	130 - 701	56	164 - 734	12.5	30 - 31	40	151 - 1552	69	222 - 1622	29
13.5 - 13.99	25	130 - 701	56	164 - 734	13	31.01 - 32	40	149 - 1602	69	222 - 1674	30
14 - 14.49	25	136 - 752	56	170 - 786	13.5	32.01 - 33	40	148 - 1653	69	222 - 1726	31
14.5 - 14.99	25	135 - 752	56	170 - 787	14	33.01 - 34	40	146 - 1702	69	222 - 1777	32
15 - 15.99	25	134 - 802	56	170 - 838	14.5	34.01 - 35	40	146 - 1753	69	222 - 1828	32
16 - 16.79	25	134 - 852	56	171 - 888	15.5	35.01 - 36	40	143 - 1803	69	222 - 1881	34
16.8 - 17.69	25	133 - 902	56	171 - 939	16.2	36.01 - 37	40	143 - 1852	69	222 - 1930	34
17.7 - 18.69	25	131 - 952	56	171 - 991	17.2	37.01 - 38	40	140 - 1903	69	222 - 1984	36
18.7 - 19.69	25	130 - 1003	56	170 - 1043	18.2	38.01 - 39	40	146 - 1953	69	227 - 2033	36
19.7 - 20.69	32	128 - 1053	60	170 - 1095	19	39.01 - 40	40	143 - 2003	69	227 - 2086	38
20.7 - 21.69	32	128 - 1103	60	171 - 1145	20						
21.7 - 22.69	32	126 - 1153	60	171 - 1197	21						
22.7 - 23.69	32	125 - 1203	60	171 - 1248	22						

Please provide the driver shape necessary for your request

Grade
Insert
Ext. Toolholder
Int. Toolholder
Threading
Grooving
Miniature tool
Milling cutter
Endmill
Drilling tool
Tooling System
User's Guide
Index



**AVAILABLE RANGE OF TAILOR-MADE DRILL BODIES (FOR GUN DRILL MACHINES)
 TRLG, TRLGCH (FOR DRILLING CROSS HOLE APPLICATIONS)**

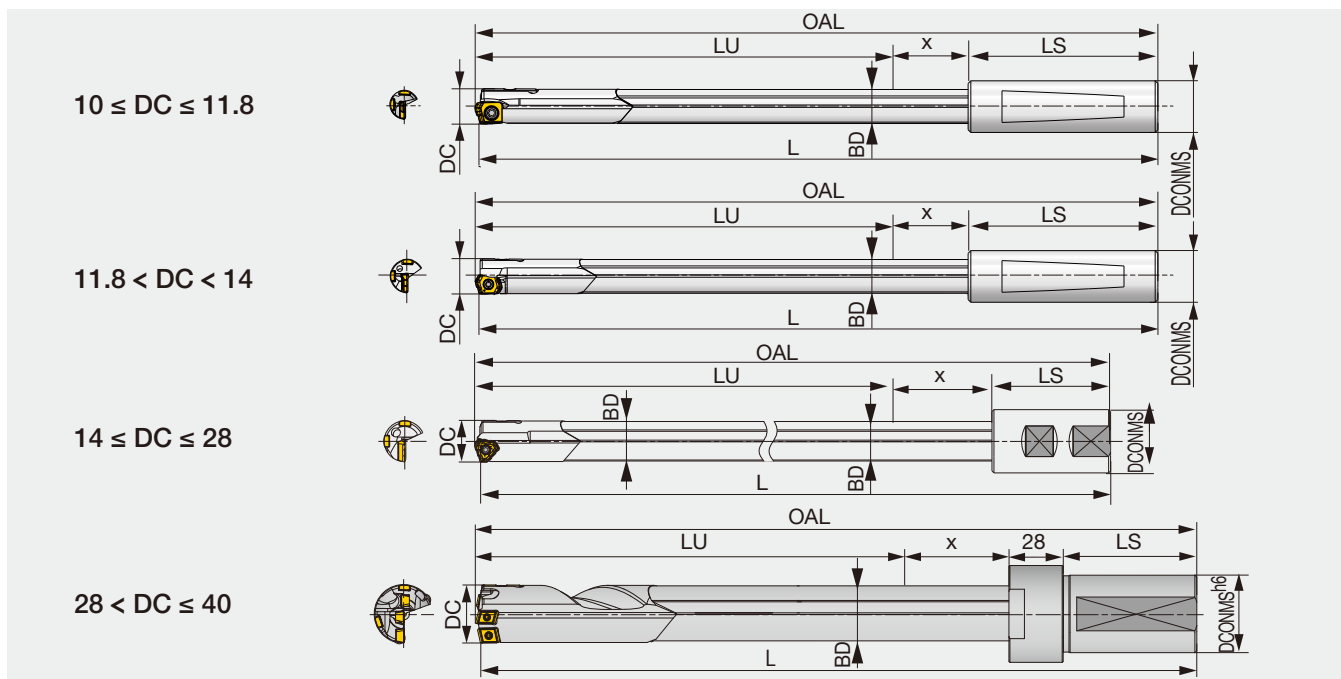

DC	L	x	BD	DC	L	x	BD
10 - 10.39	400 - 1650	15	9.6	23.7 - 24.69	400 - 2400	36	23
10.4 - 10.69	400 - 1650	16	9.9	24.7 - 25.69	400 - 2400	37	24
10.7 - 10.99	400 - 1650	16	10.2	25.7 - 26.69	400 - 2400	39	25
11 - 11.49	400 - 1650	17	10.5	26.7 - 27.69	400 - 2400	40	26
11.5 - 11.99	400 - 1650	17	11	27.7 - 28	400 - 2400	42	27
12 - 12.49	400 - 2400	18	11.5	28.01 - 29	400 - 2400	42	27
12.5 - 12.99	400 - 2400	19	12	29.01 - 29.99	400 - 2400	44	28
13 - 13.49	400 - 2400	20	12.5	30 - 31	400 - 2400	45	29
13.5 - 13.99	400 - 2400	20	13	31.01 - 32	400 - 2400	47	30
14 - 14.49	400 - 2400	21	13.5	32.01 - 33	400 - 2400	48	31
14.5 - 14.99	400 - 2400	22	14	33.01 - 34	400 - 2400	50	32
15 - 15.99	400 - 2400	23	14.5	34.01 - 35	400 - 2400	50	32
16 - 16.79	400 - 2400	24	15.5	35.01 - 36	400 - 2400	53	34
16.8 - 17.69	400 - 2400	25	16.2	36.01 - 37	400 - 2400	53	34
17.7 - 18.69	400 - 2400	27	17.2	37.01 - 38	400 - 2400	56	36
18.7 - 19.69	400 - 2400	28	18.2	38.01 - 39	400 - 2400	56	36
19.7 - 20.69	400 - 2400	30	19	39.01 - 40	400 - 2400	59	38
20.7 - 21.69	400 - 2400	31	20				
21.7 - 22.69	400 - 2400	33	21				
22.7 - 23.69	400 - 2400	34	22				

Please provide the driver shape necessary for your request

INSERT

ZSGT-NDJ

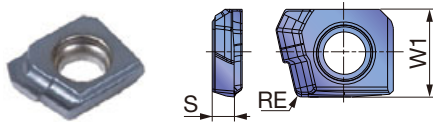

P	Steel	★						
M	Stainless	★						
K	Cast iron	★						
N	Non-ferrous	★						
S	Superalloys	★						
H	Hard materials	★						

★ : First choice
☆ : Second choice

Designation	DCN	DCX	Coated						W1	S	RE
			AH9130								
ZSGT060204R-NDJ	10	11.8	●						6	1.5	0.4

● : Line up
Package quantity = 10 pcs.

LOGT-NDJ

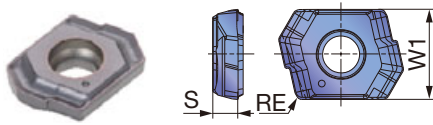

P	Steel	★	☆					
M	Stainless	★	☆					
K	Cast iron	★	☆					
N	Non-ferrous	★	☆					
S	Superalloys	★	☆					
H	Hard materials	★	☆					

★ : First choice
☆ : Second choice

Designation	DCN	DCX	Coated						W1	S	RE
			AH9130	AH725							
LOGT060204R-NDJ	11.81	13.99	●	●					7.08	2	0.4

● : Line up
Package quantity = 10 pcs.

TOHT-NDJ (070..., 080...)

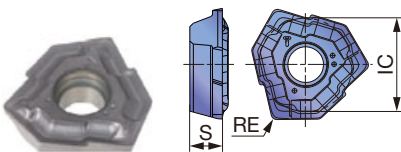

TOHT-NDJ (090... - 120...)

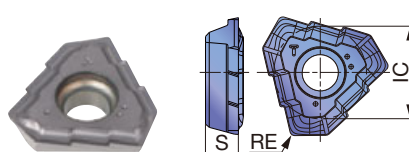

P	Steel	★	☆					
M	Stainless	★	☆					
K	Cast iron	★	☆					
N	Non-ferrous	★	☆					
S	Superalloys	★	☆					
H	Hard materials	★	☆					

★ : First choice
☆ : Second choice

Designation	DCN	DCX	Coated						IC	S	RE
			AH9130	AH725							
TOHT070304R-NDJ	14	15.99	●	●					7.69	2.3	0.4
TOHT080305R-NDJ	16	18	●	●					8.55	2.8	0.5
TOHT090305R-NDJ	18.01	20	●	●					8.32	3	0.5
TOHT100305R-NDJ	20.01	21.99	●	●					9.23	3.3	0.5
TOHT110405R-NDJ	22	25	●	●					10.4	3.8	0.5
TOHT120405R-NDJ	25.01	28	●	●					11.59	4.3	0.5

● : Line up
Package quantity = 10 pcs.

Grade
Insert
Ext. Toolholder
Int. Toolholder
Threading
Grooving
Miniature tool
Milling cutter
Endmill
Drilling tool
Tooling System
User's Guide
Index





TOHT-NDL (07..., 08...)

TOHT-NDL (09... - 12...)

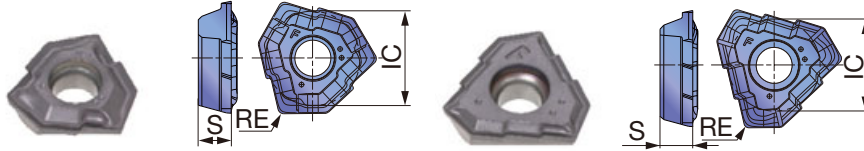

P	Steel	★			
M	Stainless	★			
K	Cast iron	★			
N	Non-ferrous	★			
S	Superalloys	★			
H	Hard materials	★			

★ : First choice
☆ : Second choice

Designation	DCN	DCX	Coated						IC	S	RE
			AH725								
TOHT070304R-NDL	14	15.99	●						7.69	2.3	0.4
TOHT080305R-NDL	16	18	●						8.55	2.8	0.5
TOHT090305R-NDL	18.01	20	●						8.32	3	0.5
TOHT100305R-NDL	20.01	21.99	●						9.23	3.3	0.5
TOHT110405R-NDL	22	25	●						10.4	3.8	0.5
TOHT120405R-NDL	25.01	28	●						11.59	4.3	0.5

● : Line up
Package quantity = 10 pcs.

Identifications for NDL and NDJ geometries

Chipbreaker	NDL	NDJ
Cutting edge strength	Sharp	Strong
ID on insert		

Recommended feed rates

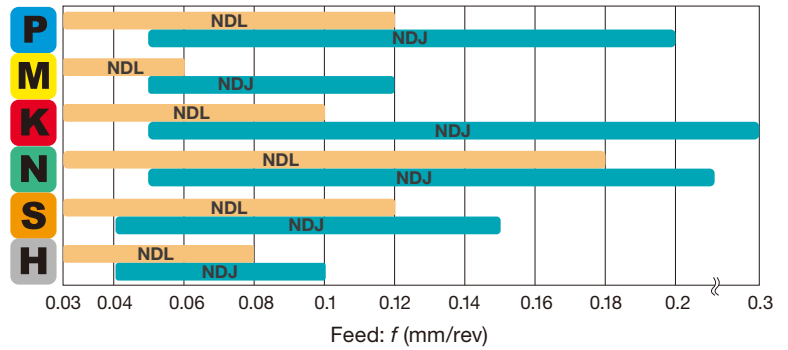

FBM-C (For central)

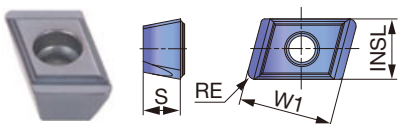

P	Steel	★	☆	☆	
M	Stainless	★	☆	☆	
K	Cast iron	★	☆	☆	
N	Non-ferrous	★	☆	☆	
S	Superalloys	☆	☆	★	
H	Hard materials	☆	☆	★	

★ : First choice
☆ : Second choice

Designation	INSL	W1	Coated			S	DCN	DCX	RE
			AH9130	AH725	AH8015				
FBM070408L-G-C	6.5	10	●	●	●	4	28.01	35	0.8
FBM080408L-G-C	8	10	●	●	●	4	35.01	40	0.8

● : Line up
Package quantity = 10 pcs.

INSERT

FBM-I (For intermediate)

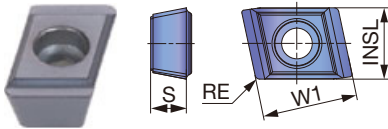

P	Steel	★	☆	☆	
M	Stainless	★	☆	☆	
K	Cast iron	★	☆	☆	
N	Non-ferrous	★	☆	☆	
S	Superalloys	☆	☆	★	
H	Hard materials	☆	☆	★	

★ : First choice
☆ : Second choice

Designation	INSL	W1	Coated				S	DCN	DCX	RE
			AH9130	AH725	AH8015					
FBM060304R-G-I	5.5	8	●	●	●		3	28.01	29.99	0.4
FBM060304R-DL-I	5.5	8	☆	●	☆		3	28.01	29.99	0.4
FBM070404R-G-I	6.5	10	●	●	●		4	30	40	0.4
FBM070404R-DL-I	6.5	10	☆	●	☆		4	30	40	0.4

● : Line up
Package quantity = 10 pcs.

FBH-P (For peripheral)

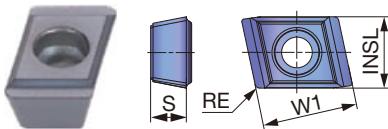

P	Steel	★	☆	☆	☆
M	Stainless	★	☆	☆	☆
K	Cast iron	★	☆	☆	☆
N	Non-ferrous	★	☆	☆	☆
S	Superalloys	☆	☆	★	☆
H	Hard materials	☆	☆	★	

★ : First choice
☆ : Second choice

Designation	INSL	W1	Coated				S	DCN	DCX	RE
			AH9130	AH725	AH8015	UC3120				
FBH060304R-G-P	6	8	☆	●	☆	▲	3	28.01	29.99	0.4
FBH060308R-G-P	6	8	●	●	●		3	28.01	29.99	0.8
FBH080404R-G-P	7.5	10	☆	●	☆	▲	4	30	38	0.4
FBH080408R-G-P	7.5	10	●	●	●		4	30	38	0.8
FBH090404R-G-P	9	10	☆	●	☆	▲	4	38.01	40	0.4
FBH090408R-G-P	9	10	●	●	●		4	38.01	40	0.8

● : Line up
▲ : To be discontinued
Package quantity = 10 pcs.

Recommended feed rates

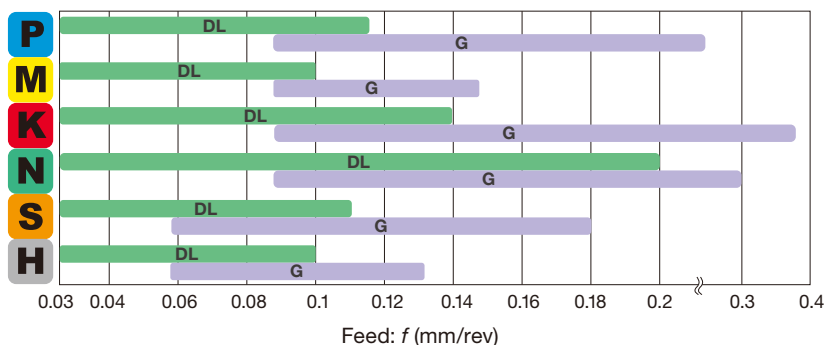

Note: For cross hole drilling, please use the DL type chipbreaker because the feed needs to be reduced.

Grade
Insert
Ext. Toolholder
Int. Toolholder
Threading
Grooving
Miniature tool
Milling cutter
Endmill
Drilling tool
Tooling System
User's Guide
Index



CARBIDE GUIDE PADS

GP04, 05, 06, 07, 08

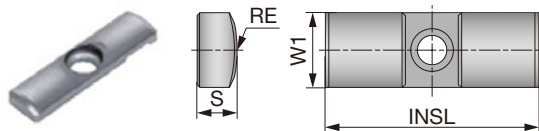

P	Steel	☆	★	☆
M	Stainless	☆	☆	★
K	Cast iron	☆	★	☆
N	Non-ferrous	☆	★	☆
S	Superalloys	☆	★	☆
H	Hard materials	☆	★	☆

★ : First choice
☆ : Second choice

Designation	DCN	DCX	Coated			W1	INSL	S	RE
			F1122	FH3125	FH3135				
GP04-16-045-DC	10	10.99	●			4	16	1.8	4.5
GP04-16-050-DC	11	11.99	●			4	16	1.8	5
GP04-055	12	13.99	●			4	16	2	5.5
GP04-16-055-DC	12	13.99	●	●		4	16	2	5.5
GP05-060	14	15.99	●			5	18	2.5	6
GP05-18-060-DC	14	15.99	●	●		5	18	2.5	6
GP05-075	16	18	●			5	18	2.5	7.5
GP05-18-075-DC	16	18	●	●		5	18	2.5	7.5
GP06-085	18.01	21	●			6	20	3	8.5
GP06-20-085-DC	18.01	21	●	●		6	20	3	8.5
GP06-100	21.01	25	●			6	20	3	10
GP06-20-100-DC	21.01	25	●	●		6	20	3	10
GP06	25.01	33	●			6	20	3	12
GP06-20-120-DC	25.01	33	●	●		6	20	3	12
GP07	33.01	38	●			7	20	3.5	12
GP07-20-120-DC	33.01	38	●	●		7	20	3.5	12
GP08	38.01	40	●			8	25	4.5	15.5
GP08-25-155-DC	38.01	40	●	●		8	25	4.5	15.5

● : Line up
Package quantity = 5 pcs.

SHIMS

For fine adjustments of hole diameters

SHIMSET-GP04

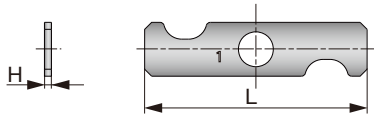

SHIMSET-GP05

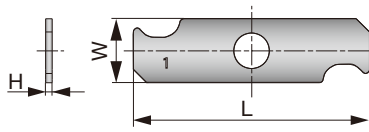

SHIMSET-GP06

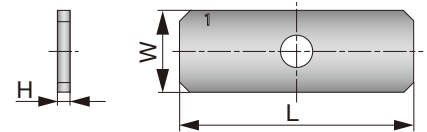

Designation	DC	W	L	H
SHIMSET-GP04	10 - 13.99	4	16	0.01 - 0.05
SHIMSET-GP05	14 - 18	5	18	0.01 - 0.05
SHIMSET-GP06	18.01 - 33	5	18	0.01 - 0.05

- A shim set contains 5 shims in thicknesses of 0.01 mm, 0.02 mm, 0.03 mm, 0.04 mm, and 0.05 mm, respectively.
 - Adjusting shims are sold by set only, not to be sold separately.

Shim combinations for various diameters

Diameter adjustments	Shim(s) for measuring guide pad	Shim(s) for supporting guide pad	Number of shim sets needed
+0.01	0.01	-	1
+0.02	0.02	0.01	1
+0.03	0.03	0.01 + 0.02	1
+0.04	0.04	0.01 + 0.03	1
+0.05	0.05	0.02 + 0.03	1
+0.06	0.01 + 0.05	0.02 + 0.04	1
+0.07	0.02 + 0.05	0.03 + 0.04	1
+0.08	0.03 + 0.05	0.04 + 0.04	2
+0.09	0.04 + 0.05	0.04 + 0.05	2
+0.1	0.05 + 0.05	0.04 + 0.04 + 0.02	2

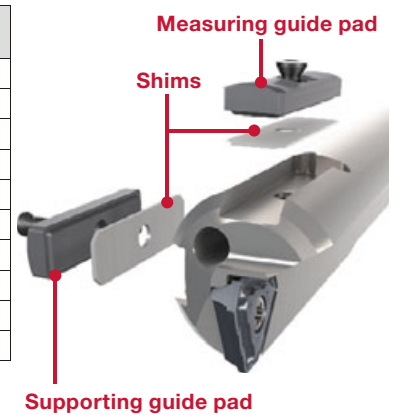

How to install adjusting shims

1. Measure the drill diameter.



2. Select the shim sizes for adjustment.

Note: Consider that the hole diameter may expand during drilling (for +0.02 to +0.03 mm).

<https://www.joss.si/product/deeptri-drill/>



3. Remove the guide pads.



4. Place the shims underneath both guide pads.

5. Measure to make sure the required diameter is achieved.



6. Drill a test hole to ensure the required hole size is achieved.

Note: For higher drilling precision, drill a hole after Step 1 to confirm the size difference between the measured drill diameter and actual drilled hole diameter.

Grade
Insert
Ext. Toolholder
Int. Toolholder
Threading
Grooving
Miniature tool
Milling cutter
Endmill
Drilling tool
Tooling System
User's Guide
Index



STANDARD CUTTING CONDITIONS

Drill diameter: DC = $\varnothing 10 - \varnothing 28$ mm

ISO	Workpiece material	Hardness	Priority	Chip-breaker	Grade	Cutting speed Vc (m/min)	Feed: f (mm/rev)			
							$\varnothing 10 - \varnothing 11.8$	$\varnothing 11.81 - \varnothing 13.99$	$\varnothing 14 - \varnothing 18$	$\varnothing 18.01 - \varnothing 28$
P	Low carbon steel (C < 0.3) SS400, SM490, S25C, etc. E275A, C25, etc.	- 200 HB	Lower feed	NDL	AH725	50 - 100	-	-	0.03 - 0.1	0.03 - 0.1
			First choice	NDJ	AH9130	80 - 140	0.05 - 0.08	0.05 - 0.1	0.06 - 0.12	0.08 - 0.16
	Carbon steel (C > 0.3) S45C, S55C, etc. C45, C55, etc.	- 300 HB	Lower feed	NDL	AH725	50 - 100	-	-	0.03 - 0.1	0.03 - 0.12
			First choice	NDJ	AH9130	80 - 140	0.05 - 0.14	0.05 - 0.16	0.07 - 0.18	0.08 - 0.2
	Low alloy steel (C < 0.3) SCM415, 18CrMo4, etc.	- 200 HB	Lower feed	NDL	AH725	50 - 100	-	-	0.03 - 0.12	0.08 - 0.1
			First choice	NDJ	AH9130	80 - 140	0.05 - 0.08	0.05 - 0.1	0.06 - 0.12	0.08 - 0.16
	Alloy steel (C > 0.3) SCM440, SCr420, 42CrMo4, 20Cr4, etc.	- 300 HB	Lower feed	NDL	AH725	50 - 100	-	-	0.03 - 0.1	0.03 - 0.12
			First choice	NDJ	AH9130	80 - 120	0.05 - 0.14	0.05 - 0.16	0.07 - 0.18	0.08 - 0.2
M*	Stainless steel (Austenitic) SUS304, SUS316, etc. X5CrNi18-9, X5CrNiMo17-12-3, etc.	- 200 HB	Lower feed	NDL	AH725	50 - 100	-	-	0.03 - 0.06	0.03 - 0.06
			First choice	NDJ	AH9130	60 - 100	0.05 - 0.08	0.05 - 0.1	0.05 - 0.1	0.05 - 0.12
	Stainless steel (Martensitic, Ferritic) SUS430, SUS416, etc. X6Cr17, X12CrS13, etc.	- 200 HB	Lower feed	NDL	AH725	50 - 100	-	-	0.03 - 0.06	0.03 - 0.06
			First choice	NDJ	AH9130	60 - 100	0.05 - 0.08;	0.05 - 0.1	0.05 - 0.1	0.05 - 0.12
	Stainless steel (Precipitation hardening) SUS630, X5CrNiCuNb16-4, etc.	-	Lower feed	NDL	AH725	50 - 100	-	-	0.03 - 0.06	0.03 - 0.06
			First choice	NDJ	AH9130	60 - 100	0.05 - 0.08	0.05 - 0.1	0.05 - 0.1	0.05 - 0.12
K	Grey cast iron FC250, GG25, 250, etc.	150 - 250 HB	Lower feed	NDL	AH725	50 - 100	-	-	0.03 - 0.15	0.05 - 0.18
			First choice	NDJ	AH9130	80 - 140	0.05 - 0.2	0.05 - 0.25	0.05 - 0.25	0.05 - 0.3
	Ductile cast iron FCD700, 700-2, etc.	150 - 250 HB	Lower feed	NDL	AH725	50 - 100	-	-	0.03 - 0.15	0.05 - 0.18
			First choice	NDJ	AH9130	80 - 140	0.05 - 0.2	0.05 - 0.25	0.05 - 0.25	0.05 - 0.3
N	Aluminium alloys	-	Lower feed	NDL	AH725	80 - 160	-	-	0.03 - 0.15	0.03 - 0.15
			First choice	NDJ	AH9130	100 - 200	0.05 - 0.18	0.05 - 0.2	0.08 - 0.22	0.1 - 0.25
S	Heat-resistant alloys Inconel 718, etc.	- 40 HRC	Lower feed	NDL	AH725	20 - 50	-	-	0.03 - 0.06	0.03 - 0.08
			First choice	NDJ	AH9130	20 - 50	0.04 - 0.06	0.04 - 0.08	0.04 - 0.08	0.04 - 0.1
H	Titanium alloys Ti-6Al-4V, etc.	- 40 HRC	Lower feed	NDL	AH725	30 - 60	-	-	0.03 - 0.1	0.03 - 0.12
			First choice	NDJ	AH9130	30 - 60	0.04 - 0.1	0.05 - 0.13	0.05 - 0.13	0.05 - 0.15
H	Hardened steel	- 50 HRC	Lower feed	NDL	AH725	40 - 100	-	-	0.03 - 0.08	0.03 - 0.08
			First choice	NDJ	AH9130	50 - 100	0.04 - 0.06	0.04 - 0.08	0.04 - 0.08	0.04 - 0.1

The use of NDL chipbreakers is recommended for cross hole drilling with low feed conditions.

*Coolant recommendations for drilling stainless steel:

- Oil coolant is first priority

- Water soluble coolant requires at least 20% oil concentration

Drill diameter: DC = $\varnothing 28.01 - \varnothing 40$ mm

ISO	Workpiece material	Hardness	Priority	For central		For intermediate		For peripheral		Cutting speed Vc (m/min)	Feed f (mm/rev) $\varnothing 28.01 - \varnothing 40$
				Chip-breaker	Grade	Chip-breaker	Grade	Chip-breaker	Grade		
P	Low carbon steel (C < 0.3) SS400, SM490, S25C, etc. E275A, C25, etc.	- 200 HB	Lower feed	G	AH725	DL	AH725	G	AH725	50 - 100	0.03 - 0.1
			First choice	G	AH725	G	AH725	G	AH725	80 - 140	0.1 - 0.25
	Carbon steel (C > 0.3) S45C, S55C, etc. C45, C55, etc.	- 300 HB	Lower feed	G	AH725	DL	AH725	G	AH725	50 - 100	0.03 - 0.12
			First choice	G	AH725	G	AH725	G	AH725	80 - 140	0.1 - 0.3
	Low alloy steel (C < 0.3) SCM415, 18CrMo4, etc.	- 200 HB	Lower feed	G	AH725	DL	AH725	G	AH725	50 - 100	0.03 - 0.1
			First choice	G	AH725	G	AH725	G	AH725	80 - 140	0.1 - 0.25
	Alloy steel (C > 0.3) SCM440, SCr420, 42CrMo4, 20Cr4, etc.	- 300 HB	Lower feed	G	AH725	DL	AH725	G	AH725	50 - 100	0.03 - 0.12
			First choice	G	AH725	G	AH725	G	AH725	80 - 120	0.1 - 0.3
M*	Stainless steel (Austenitic) SUS304, SUS316, etc. X5CrNi18-9, X5CrNiMo17-12-3, etc.	- 200 HB	Lower feed	G	AH8015	DL	AH725	G	AH725	50 - 100	0.03 - 0.1
			First choice	G	AH8015	G	AH8015	G	AH8015	60 - 100	0.1 - 0.15
	Stainless steel (Martensitic, Ferritic) SUS430, SUS416, etc. X6Cr17, X12CrS13, etc.	- 200 HB	Lower feed	G	AH8015	DL	AH725	G	AH725	50 - 100	0.03 - 0.1
			First choice	G	AH8015	G	AH8015	G	AH8015	60 - 100	0.1 - 0.15
	Stainless steel (Precipitation hardening) SUS630, X5CrNiCuNb16-4, etc.	-	Lower feed	G	AH8015	DL	AH725	G	AH725	50 - 100	0.03 - 0.1
			First choice	G	AH8015	G	AH8015	G	AH8015	60 - 100	0.1 - 0.15
K	Grey cast iron FC250, GG25, 250, etc.	150 - 250 HB	Lower feed	G	AH725	DL	AH725	G	AH725	50 - 100	0.03 - 0.14
			First choice	G	AH725	G	AH725	G	AH725	80 - 140	0.1 - 0.35
	Ductile cast iron FCD700, 700-2, etc.	150 - 250 HB	Lower feed	G	AH725	DL	AH725	G	AH725	50 - 100	0.03 - 0.14
			First choice	G	AH725	G	AH725	G	AH725	80 - 140	0.1 - 0.35
N	Aluminium alloys	-	Lower feed	G	AH725	DL	AH725	G	AH725	80 - 160	0.03 - 0.2
			First choice	G	AH725	G	AH725	G	AH725	100 - 200	0.1 - 0.3
S	Heat-resistant alloys Inconel 718, etc.	- 40 HRC	Lower feed	G	AH8015	DL	AH725	G	AH725	20 - 50	0.03 - 0.08
			First choice	G	AH8015	G	AH8015	G	AH8015	20 - 50	0.06 - 0.13
H	Titanium alloys Ti-6Al-4V, etc.	- 40 HRC	Lower feed	G	AH725	DL	AH725	G	AH725	30 - 60	0.03 - 0.1
			First choice	G	AH725	G	AH725	G	AH725	30 - 60	0.1 - 0.18
H	Hardened steel	- 50 HRC	Lower feed	G	AH8015	DL	AH725	G	AH725	40 - 100	0.03 - 0.1
			First choice	G	AH8015	G	AH8015	G	AH8015	50 - 100	0.06 - 0.13

The use of DL chipbreakers is recommended for cross hole drilling with low feed conditions.

*Coolant recommendations for drilling stainless steel:

- Oil coolant is first priority

- Water soluble coolant requires at least 20% oil concentration

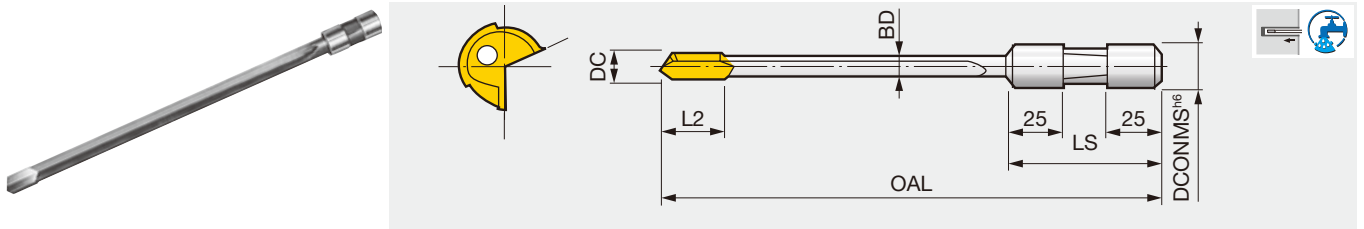

Designation	DC	DCONMS	L2	OAL
SLJ0300L0400NA	3	12.7	15	400
SLJ0300L0600NA	3	12.7	15	600
SLJ0500L0600NA	5	12.7	25	600
SLJ0550L0600NA	5.5	19.05	25	600
SLJ0600L0600NA	6	19.05	25	600
SLJ0700L0600NA	7	19.05	25	600
SLJ0800L0600NA	8	19.05	25	600
SLJ1000L0600NA	10	19.05	30	600
SLJ0500L1000NA	5	12.7	25	1000
SLJ0600L1000NA	6	19.05	25	1000
SLJ0700L1000NA	7	19.05	25	1000
SLJ0800L1000NA	8	19.05	25	1000
SLJ1000L1000NA	10	19.05	30	1000
SLJ0600L1250NA	6	19.05	25	1250
SLJ0610L1250NA	6.1	19.05	25	1250
SLJ0620L1250NA	6.2	19.05	25	1250
SLJ0700L1250NA	7	19.05	25	1250
SLJ0800L1250NA	8	19.05	25	1250
SLJ0810L1250NA	8.1	19.05	25	1250
SLJ0820L1250NA	8.2	19.05	25	1250
SLJ1000L1250NA	10	19.05	30	1250
SLJ1010L1250NA	10.1	19.05	30	1250
SLJ1020L1250NA	10.2	19.05	30	1250
SLJ1200L1250NA	12	19.05	30	1250
SLJ1210L1250NA	12.1	19.05	30	1250
SLJ1220L1250NA	12.2	19.05	30	1250
SLJ0600L1650NA	6	19.05	25	1650
SLJ0610L1650NA	6.1	19.05	25	1650
SLJ0620L1650NA	6.2	19.05	25	1650
SLJ0700L1650NA	7	19.05	25	1650
SLJ0800L1650NA	8	19.05	25	1650
SLJ0810L1650NA	8.1	19.05	25	1650
SLJ0820L1650NA	8.2	19.05	25	1650
SLJ1000L1650NA	10	19.05	30	1650
SLJ1010L1650NA	10.1	19.05	30	1650
SLJ1020L1650NA	10.2	19.05	30	1650
SLJ1200L1650NA	12	19.05	30	1650
SLJ1210L1650NA	12.1	19.05	30	1650
SLJ1220L1650NA	12.2	19.05	30	1650

TUBE DIAMETER

DC	BD	DC	BD	DC	BD
3 - 3.19	2.9	5.2 - 5.49	5	8.7 - 9.19	8.5
3.2 - 3.39	3.1	5.5 - 5.79	5.3	9.2 - 9.69	9
3.4 - 3.59	3.3	5.8 - 5.99	5.6	9.7 - 10.39	9.5
3.6 - 3.89	3.5	6 - 6.19	5.8	10.4 - 10.89	10
3.9 - 4.09	3.7	6.2 - 6.59	5.9	10.9 - 11.39	10.6
4.1 - 4.29	3.9	6.6 - 7.09	6.4	11.4 - 11.99	11.1
4.3 - 4.49	4.1	7.1 - 7.59	6.9	12 - 12.2	11.7
4.5 - 4.89	4.3	7.6 - 8.09	7.4		
4.9 - 5.19	4.7	8.1 - 8.69	7.9		

STANDARD CUTTING CONDITIONS

See more information

e-catalog



Drill Head Category





Series	Designation	Shape	Drill diameter (mm)	Coolant supply	IT class	Surface finish Ra (μm)*3	Thread type			
							External single thread	External double thread	External quadruple thread	Internal single thread
TRI-FINE	FNTR		$\phi 16 - \phi 28$	Internal	IT10	2	-	-	○	○
FINE-BEAM	FNBN		$\phi 25 - \phi 89$	Internal	IT10	2	-	-	○	○
UNIDEX	KUSTS		$\phi 38 - \phi 293.99$	Internal	IT10	3	-	-	○	○
TRI-FINE	FNTR-D		$\phi 18.4 - \phi 28$	Internal	IT10	2	-	-	○	-
FINE-BEAM	FNBR-D		$\phi 25 - \phi 65$	Internal	IT10	2	-	-	○	-
UNIDEX	KUDTS		$\phi 38 - \phi 183.99$	Internal	IT10	3	-	-	○	-
Brazed	MBU		$\phi 8 - \phi 14.79$	Internal	IT9	2	○	-	-	-
	UTE		$\phi 12.6 - \phi 20$	Internal	IT9	2	-	○ ^{*1}	○ ^{*2}	-
	BTU		$\phi 12.6 - \phi 65$	Internal	IT9	2	-	○ ^{*1}	○ ^{*2}	-
	ETU		$\phi 18.4 - \phi 65$	Internal	IT9	2	-	-	○	-

*1: UTE & BTU Drill head : $\phi 12.6 \text{ mm} - \phi 15.59 \text{ mm}$, External double thread

*2: UTE & BTU Drill head : $\phi 15.6 \text{ mm}$ -, External quadruple thread

*3: Just for reference

★ : First choice
☆ : Second choice

Tube system	Machine				Workpiece material						Note	Page
	Deep hole drilling machines	Lathes	Vertical machining centers	Horizontal machining centers	P	M	K	N	S	H		
 (Single Tube System)	○	-	-	-	★	★	★	★	★	★	Indexable	J116 -
	○	-	-	-	★	★	★	★	★	★	Indexable	J121 -
	○	-	-	-	★	★	★	★	★	★	Indexable	J129 -
 (Double Tube System)	○	○	○	○	★	★	★	★	★	★	Indexable	J118
	○	○	○	○	★	★	★	★	★	★	Indexable	J123
	○	○	○	○	★	★	★	★	★	★	Indexable	J141 -
 (Single Tube System)	○	-	-	-	★	★	★	★	☆	☆	Brazed	J150
	○	-	-	-	★	★	★	★	☆	☆	Brazed	J151
	○	-	-	-	★	★	★	★	☆	☆	Brazed	J152 -
 (Double Tube System)	○	○	○	○	★	★	★	★	☆	☆	Brazed	J155

Grade	A
Insert	B
Ext. Toolholder	C
Int. Toolholder	D
Threading	E
Grooving	F
Miniature tool	G
Milling cutter	H
Endmill	I
Drilling tool	J
Tooling System	K
User's Guide	L
Index	M

Indexable head with external 4-start thread for single tube system (STS)

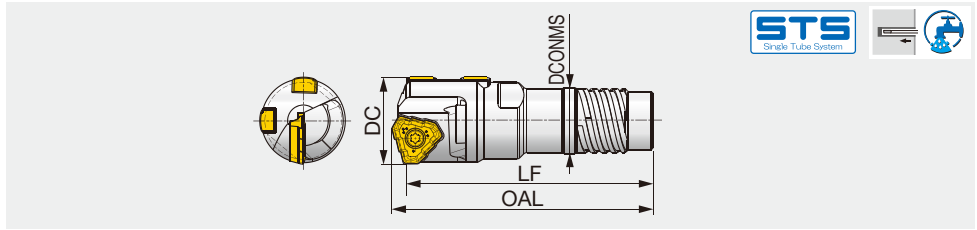

Standard products

Designation	DC	Drill tube		OAL	LF	DCONMS	Insert	Guide pad
		Designation	Dia. (mm)					
FNTR-0097S-16.00	16	ST0097	14	58	55	12.6	TOHT08...	GP06-075, GP06-20-075-DC
FNTR-0000S-20.00	20	ST0000	17	59	56	15.5	TOHT09...	GP06-085, GP06-20-085-DC
FNTR-00S-21.00	21	ST00	18	62	60	16	TOHT10...	GP06-085, GP06-20-085-DC
FNTR-01S-24.00	24	ST01	20	69	65.5	18	TOHT11...	GP06-100, GP06-20-100-DC
FNTR-02S-25.00	25	ST02	22	69	65.5	19.5	TOHT11...	GP06-100, GP06-20-100-DC
FNTR-02S-25.40	25.4	ST02	22	69	65.5	19.5	TOHT12...	GP06, GP06-20-120-DC

Non-standard products (to be supplied on request)

When ordering

FNTR-S** - **XX.XX**

Drill head - Diameter (mm)

e.g. Designation for tool diameter $\varnothing 16.5$ mm: **FNTR-0097S-16.50**

Designation	DCN	DCX	Drill tube		OAL	LF	DCONMS	Insert	Guide pad
			Designation	Dia. (mm)					
FNTR-0097S-xx.xx	16	16.7	ST0097	14	57	55	12.6	TOHT08...	GP06-075, GP06-20-075-DC
FNTR-0098S-xx.xx	16.71	17.7	ST0098	15	57	55	13.6	TOHT08...	GP06-075, GP06-20-075-DC
FNTR-0099S-xx.xx	17.71	18	ST0099	16	59	56	14.5	TOHT08...	GP06-075, GP06-20-075-DC
FNTR-0099S-xx.xx	18.01	18.9	ST0099	16	59	56	14.5	TOHT09...	GP06-085, GP06-20-085-DC
FNTR-0000S-xx.xx	18.91	20	ST0000	17	59	56	15.5	TOHT09...	GP06-085, GP06-20-085-DC
FNTR-00S-xx.xx	20.01	21.8	ST00	18	63	60	16	TOHT10...	GP06-085, GP06-20-085-DC
FNTR-01S-xx.xx	21.81	24.1	ST01	20	69	65.5	18	TOHT11...	GP06-100, GP06-20-100-DC
FNTR-02S-xx.xx	24.11	26.4	ST02	22	69	65.5	19.5	TOHT11...	GP06-100, GP06-20-100-DC
FNTR-03S-xx.xx	26.41	28	ST03	24	69	65.5	21	TOHT12...	GP06, GP06-20-120-DC

INSERT SPARE PARTS

Designation	Screw	Wrench
TOHT08...	CSTB-2.5S	T-8F
TOHT09...	CSTB-2.5S	T-8F
TOHT10...	CSTB-3S	T-9F
TOHT11...	CSTB-3.5H	T-15F
TOHT12...	CSTB-4S	T-15F

GUIDE PAD SPARE PARTS

Designation	Screw	Wrench
GP06-075	CSTB-2.2S	T-7F
GP06-085, GP06-20-085-DC	CSTB-2.2S	T-7F
GP06-100, GP06-20-100-DC	CSTB-2.2S	T-7F
GP06, GP06-20-120-DC	CSTB-2.2S	T-7F

Recommended clamping torque: CSTB-2.2S = 1 N·m, CSTB-2.5S/CSTB-3S = 2.3 N·m, CSTB-3.5H/CSTB-4S = 3 N·m

STANDARD CUTTING CONDITIONS

See more information

e-catalog



Reference pages: Inserts, Guide pads → **J119 - J120**, Drill tube (STS) → **J156**

TRI-FINE STS-IN

Indexable head with internal single-start thread for single tube system (STS)

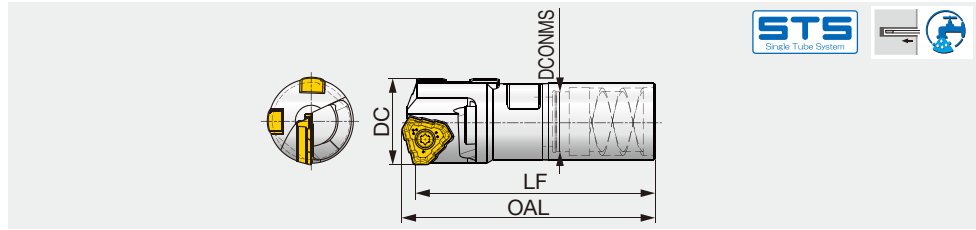

Non-standard products (to be supplied on request)

When ordering

FNTR-N (-*) - XX.XX**

Drill head

Diameter (mm)

e.g. Designation for tool diameter $\varnothing 16.5$ mm: **FNTR-13N-2-16.50**

Designation	DCN	DCX	Drill tube		OAL	LF	DCONMS	Insert	Guide pad
			Designation	Dia. (mm)					
FNTR-13N-2-xx.xx	16	16.5	UB13-1	13	55.5	53.5	10.8	TOHT08...	GP06-075, GP06-20-075-DC
FNTR-14N-1-xx.xx	16.51	17.25	UB14-1	14	55.5	53.5	12.1	TOHT08...	GP06-075, GP06-20-075-DC
FNTR-14N-2-xx.xx	17.26	18	UB14-2	14	55.5	53.5	12.1	TOHT08...	GP06-075, GP06-20-075-DC
FNTR-15N-xx.xx	18.01	19	UB15	15	57	54	12.8	TOHT09...	GP06-085, GP06-20-085-DC
FNTR-16.5N-xx.xx	19.01	19.99	UB16.5	16.5	57	54	13.8	TOHT09...	GP06-085, GP06-20-085-DC
FNTR-18N-xx.xx	20	21.99	UB18	18	61	58	14.5	TOHT09...	GP06-085, GP06-20-085-DC
FNTR-20N-xx.xx	22	24.99	UB20	20	63.5	60	16	TOHT11...	GP06-100, GP06-20-100-DC
FNTR-22N-xx.xx	25	25.99	UB22	22	63.5	60	17	TOHT11...	GP06-100, GP06-20-100-DC
FNTR-22N-xx.xx	26	26.99	UB22	22	68.5	65	17	TOHT12...	GP06, GP06-20-120-DC
FNTR-24N-xx.xx	27	28	UB24	24	68.5	65	19	TOHT12...	GP06, GP06-20-120-DC

INSERT SPARE PARTS

Designation	Screw	Wrench
TOHT08...	CSTB-2.5S	T-8F
TOHT09...	CSTB-2.5S	T-8F
TOHT10...	CSTB-3S	T-9F
TOHT11...	CSTB-3.5H	T-15F
TOHT12...	CSTB-4S	T-15F

GUIDE PAD SPARE PARTS

Designation	Screw	Wrench
GP06-075	CSTB-2.2S	T-7F
GP06-085, GP06-20-085-DC	CSTB-2.2S	T-7F
GP06-100, GP06-20-100-DC	CSTB-2.2S	T-7F
GP06, GP06-20-120-DC	CSTB-2.2S	T-7F

Recommended clamping torque: CSTB-2.2S = 1 N·m, CSTB-2.5S/CSTB-3S = 2.3 N·m, CSTB-3.5H/CSTB-4S = 3 N·m

STANDARD CUTTING CONDITIONS

See more information

e-catalog



Reference pages: Inserts, Guide pads → **J119 - J120**, Drill tube (STS) → **J158**



TRI-FINE DTS

TRI-FINE DTS-EX

Indexable head with external 4-start thread for double tube system (DTS)

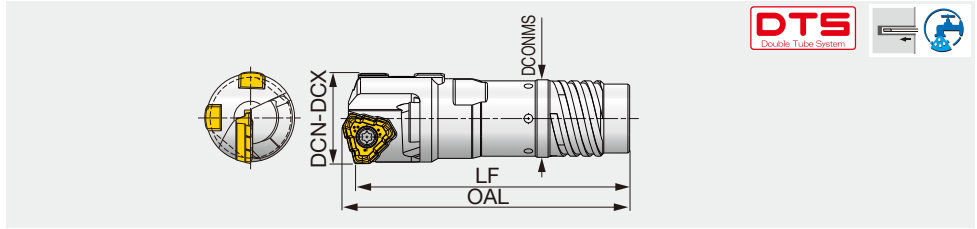

Non-standard products (to be supplied on request)

When ordering

FNTR-D - XX.XX**

Drill head

Diameter (mm)

e.g. Designation for tool diameter $\varnothing 20$ mm: FNTR-00D-20.00

Designation	DCN	DCX	Outer tube		OAL	LF	DCONMS	Insert	Guide pad
			Designation	Dia. (mm)					
FNTR-00D-xx.xx	18.4	20	OT00	18	62	59	16	TOHT09...	GP06-085, GP06-20-085-DC
FNTR-01D-xx.xx	20.01	21	OT01	19.5	66.5	63.5	18	TOHT10...	GP06-085, GP06-20-085-DC
FNTR-01D-xx.xx	21.01	21.8	OT01	19.5	66.5	63.5	18	TOHT10...	GP06-100, GP06-20-100-DC
FNTR-02D-xx.xx	21.81	21.99	OT02	21.5	66.5	63.5	19.5	TOHT10...	GP06-100, GP06-20-100-DC
FNTR-02D-xx.xx	22	24.1	OT02	21.5	69	65.5	19.5	TOHT11...	GP06-100, GP06-20-100-DC
FNTR-03D-xx.xx	24.11	25	OT03	23.5	69	65.5	21	TOHT11...	GP06-100, GP06-20-100-DC
FNTR-03D-xx.xx	25.01	26.4	OT03	23.5	71	67.5	21	TOHT12...	GP06, GP06-20-120-DC
FNTR-04D-xx.xx	26.41	28	OT04	26	74	70.5	23.5	TOHT12...	GP06, GP06-20-120-DC

INSERT SPARE PARTS

Designation	Screw	Wrench
TOHT08...	CSTB-2.5S	T-8F
TOHT09...	CSTB-2.5S	T-8F
TOHT10...	CSTB-3S	T-9F
TOHT11...	CSTB-3.5H	T-15F
TOHT12...	CSTB-4S	T-15F

GUIDE PAD SPARE PARTS

Designation	Screw	Wrench
GP06-075	CSTB-2.2S	T-7F
GP06-085, GP06-20-085-DC	CSTB-2.2S	T-7F
GP06-100, GP06-20-100-DC	CSTB-2.2S	T-7F
GP06, GP06-20-120-DC	CSTB-2.2S	T-7F

Recommended clamping torque: CSTB-2.2S = 1 N·m, CSTB-2.5S = 1.3 N·m, CSTB-3S = 2.3 N·m, CSTB-3.5H/CSTB-4S = 3 N·m

STANDARD CUTTING CONDITIONS

See more information

e-catalog



Reference pages: Inserts, Guide pads → **J119 - J120**, Drill tube (DTS) → **J160**

INSERT

TOHT-NDJ (08...)

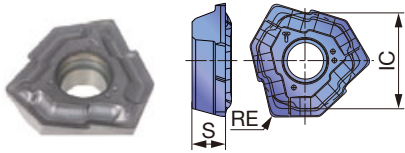

TOHT-NDJ (09... - 12...)

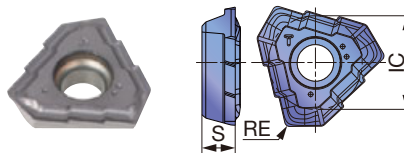

TOHT-NDL (08...)

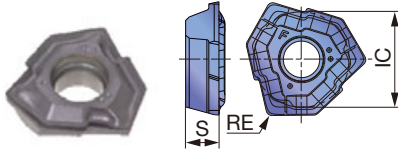

TOHT-NDL (09... - 12...)

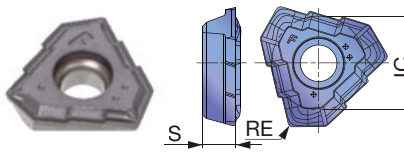

P Steel	★ ☆								
M Stainless	★ ☆								
K Cast iron	★ ☆								
N Non-ferrous	★ ☆								
S Superalloys	☆ ☆								
H Hard materials	☆ ☆								

★ : First choice
☆ : Second choice

Designation	DCN	DCX	Coated		IC	S	RE
			AH9130	AH725			
TOHT080305R-NDJ	16	18	●	●	8.55	2.8	0.5
TOHT090305R-NDJ	18.01	20	●	●	8.32	3	0.5
TOHT100305R-NDJ	20.01	21.99	●	●	9.23	3.3	0.5
TOHT110405R-NDJ	22	25	●	●	10.4	3.8	0.5
TOHT120405R-NDJ	25.01	28	●	●	11.59	4.3	0.5
TOHT080305R-NDL	16	18		●	8.55	2.8	0.5
TOHT090305R-NDL	18.01	20		●	8.32	3	0.5
TOHT100305R-NDL	20.01	21.99		●	9.23	3.3	0.5
TOHT110405R-NDL	22	25		●	10.4	3.8	0.5
TOHT120405R-NDL	25.01	28		●	11.59	4.3	0.5

● : Line up
Package quantity = 10 pcs.

Identifications for NDL and NDJ geometries

Chipbreaker	NDL	NDJ
Cutting edge strength	Sharp	Strong
ID on insert		

Recommended feed rates

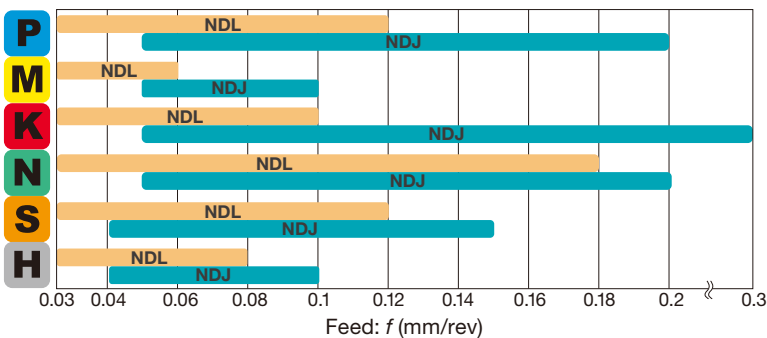

Grade
Insert
Ext. Toolholder
Int. Toolholder
Threading
Grooving
Miniature tool
Milling cutter
Endmill
Drilling tool
Tooling System
User's Guide
Index



GUIDE PAD

GP06

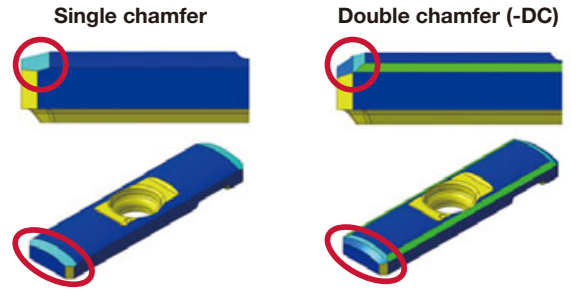
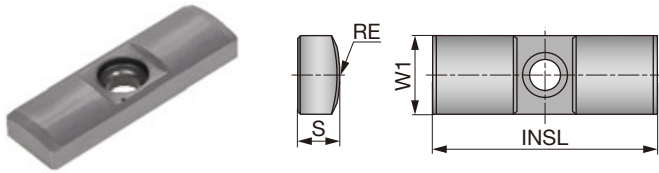

Designation	DCN	DCX	Coated			W1	INSL	S	RE	Chamfer
			F1122	FH3125	FH3135					
GP06-075	16	18	●			6	20	3	7.5	Single
GP06-20-075-DC	16	18		●		6	20	3	7.5	Double
GP06-085	18.01	21	●			6	20	3	8.5	Single
GP06-20-085-DC	18.01	21		●	●	6	20	3	8.5	Double
GP06-100	21.01	25	●			6	20	3	10	Single
GP06-20-100-DC	21.01	25		●	●	6	20	3	10	Double
GP06	25.01	29.99	●			6	20	3	12	Single
GP06-20-120-DC	25.01	29.99		●	●	6	20	3	12	Double

●: Line up
 Package quantity = 5 pcs.

Grade recommendations

ISO	Oil coolant			Water based coolant		
	First choice	Second choice	Third choice	First choice	Second choice	Third choice
P	FH3125	F1122	FH3135	FH3135	FH3125	-
M	FH3135	FH3125	F1122	FH3135	FH3125	-
K	FH3125	F1122	FH3135	FH3135	FH3125	-
N	FH3125	F1122	FH3135	FH3135	FH3125	-
S	FH3135	FH3125	F1122	FH3135	FH3125	-
H	FH3135	FH3125	F1122	FH3135	FH3125	-

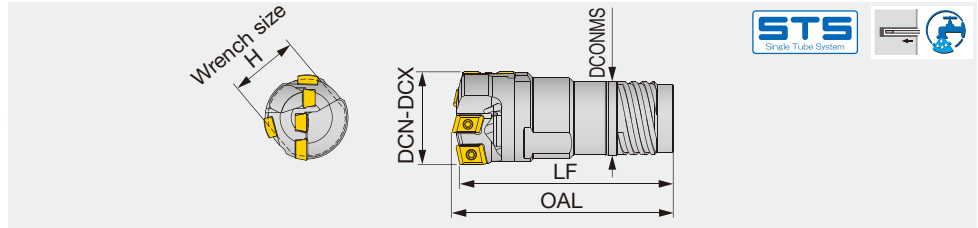

Standard products

Designation	DC	Drill tube			Drill head		
		Designation	Dia. (mm)	OAL	LF	DCONMS	H
FNBM-02S-25.00	25	ST02	22	73	70	19.5	22
FNBM-02S-25.40	25.4	ST02	22	73	70	19.5	22
FNBM-03S-28.00	28	ST03	24	73	70	21	23
FNBM-04S-29.00	29	ST04	26	78	75	23.5	24
FNBM-04S-30.00	30	ST04	26	78	75	23.5	24
FNBM-05S-31.75	31.75	ST05	28	78	75	25.5	27
FNBM-05S-32.00	32	ST05	28	78	75	25.5	27
FNBM-05S-33.00	33	ST05	28	78	75	25.5	27
FNBM-06S-35.00	35	ST06	30	83	80	28	29
FNBM-06S-36.00	36	ST06	30	83	80	28	29
FNBM-07S-37.00	37	ST07	33	93	90	30	32
FNBM-07S-38.00	38	ST07	33	93	90	30	32
FNBM-07S-38.10	38.1	ST07	33	93	90	30	32
FNBM-08S-40.00	40	ST08	36	99	95	33	35
FNBM-09S-45.00	45	ST09	39	104	100	36	38
FNBM-10S-50.00	50	ST10	43	104	100	39	41
FNBM-11S-55.00	55	ST11	47	114	110	43	46
FNBM-12S-57.15	57.15	ST12	51	120	115	47	50
FNBM-12S-60.00	60	ST12	51	120	115	47	50
FNBM-13S-65.00	65	ST13	56	120	115	51	55

Non-standard products (to be supplied on request)

When ordering

FNBM-S - XX.XX**

Drill head

Diameter (mm)

e.g. Designation for tool diameter ø30.5 mm: **FNBM-04S-30.50**

Designation	DCN	DCX	Drill tube			Drill head		
			Designation	Dia. (mm)	OAL	LF	DCONMS	H
FNBM-02S-xx.xx	25	26.4	ST02	22	73	70	19.5	22
FNBM-03S-xx.xx	26.41	28.7	ST03	24	73	70	21	23
FNBM-04S-xx.xx	28.71	31	ST04	26	78	75	23.5	24
FNBM-05S-xx.xx	31.01	33.3	ST05	28	78	75	25.5	27
FNBM-06S-xx.xx	33.31	36.2	ST06	30	83	80	28	29
FNBM-07S-xx.xx	36.21	39.6	ST07	33	93	90	30	32
FNBM-08S-xx.xx	39.61	43	ST08	36	99	95	33	35
FNBM-09S-xx.xx	43.01	47	ST09	39	104	100	36	38
FNBM-10S-xx.xx	47.01	51.7	ST10	43	104	100	39	41
FNBM-11S-xx.xx	51.71	56.2	ST11	47	114	110	43	46
FNBM-12S-xx.xx	56.21	60.6	ST12	51	120	115	47	50
FNBM-13S-xx.xx	60.61	65	ST13	56	120	115	51	55

STANDARD CUTTING CONDITIONS

See more information

e-catalog



FINE-BEAM STS

FINE-BEAM STS-IN

Indexable head with internal single-start thread for single tube system (STS)

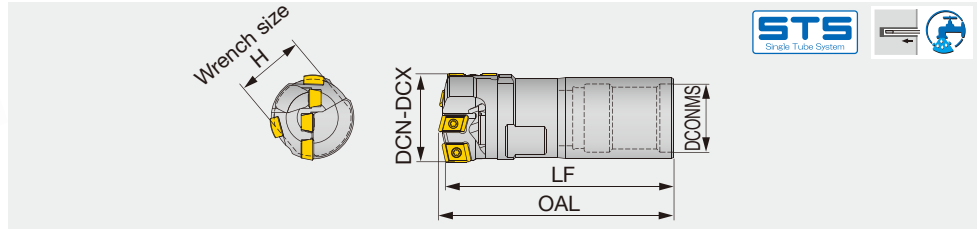

Standard products

Designation	DC	Drill tube		Drill head			
		Designation	Dia. (mm)	OAL	LF	DCONMS	H
FNBM-22N-25.00	25	UB22	22	73	70	20	19
FNBM-26N-30.00	30	UB26	26	78	75	24	24
FNBM-28N-32.00	32	UB28	28	78	75	26	26
FNBM-30N-35.00	35	UB30	30	93	90	27	28
FNBM-36N-40.00	40	UB36	36	104	100	33	32

Non-standard products (to be supplied on request)

When ordering

FNBM-N - XX.XX**

Drill head

Diameter (mm)

e.g. Designation for tool diameter ø30.5 mm: **FNBM-26N-30.50**

Designation	DCN	DCX	Drill tube		Drill head			
			Designation	Dia. (mm)	OAL	LF	DCONMS	H
FNBM-22N-xx.xx	25	26.99	UB22	22	73	70	20	19
FNBM-24N-xx.xx	27	28.7	UB24	24	73	70	22	21
FNBM-24N-xx.xx	28.71	29.99	UB24	24	73	70	22	24
FNBM-26N-xx.xx	30	31.99	UB26	26	78	75	24	24
FNBM-28N-xx.xx	32	33.99	UB28	28	78	75	26	26
FNBM-30N-xx.xx	34	36.99	UB30	30	93	90	27	28
FNBM-33N-xx.xx	37	39.99	UB33	33	98	95	30	30
FNBM-36N-xx.xx	40	43	UB36	36	104	100	33	32
FNBM-36N-xx.xx	43.01	43.99	UB36	36	104	100	33	36
FNBM-39N-xx.xx	44	46.99	UB39	39	109	105	37	36
FNBM-43N-xx.xx	47	51.7	UB43	43	109	105	41	36
FNBM-43N-xx.xx	51.71	51.99	UB43	43	109	105	41	41
FNBM-47N-xx.xx	52	56.99	UB47	47	114	110	44	46
FNBM-51N-xx.xx	57	60.6	UB51	51	120	115	49	46
FNBM-51N-xx.xx	60.61	60.99	UB51	51	120	115	49	50
FNBM-56N-xx.xx	61	65	UB56	56	120	115	53	54
FNBM-56N-xx.xx	65.01	67.99	UB56	56	112	104	53	64
FNBM-62N-xx.xx	68	74.99	UB62	62	113	104	59	71
FNBM-68N-xx.xx	75	80.99	UB68	68	143	134	65	77
FNBM-75N-xx.xx	81	89	UB75	75	143	134	71	86

STANDARD CUTTING CONDITIONS

See more information

e-catalog



Reference pages: Spare parts → **J124**, Inserts → **J126 - J127**, Guide pads → **J128**, Drill tube (STS) → **J158**

Indexable head with external 4-start thread for double tube system (DTS)

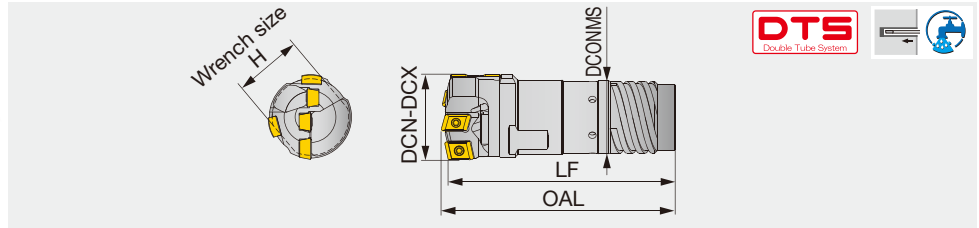

Standard products

Designation	DC	Drill tube		Drill head			
		Designation	Dia. (mm)	OAL	LF	DCONMS	H
FNBM-11D-50.00	50	OT11	46.5	114	110	43	41

Non-standard products (to be supplied on request)

When ordering

FNBM-D** - **XX.XX**

Drill head - Diameter (mm)

e.g. Designation for tool diameter $\varnothing 30.5$ mm: **FNBM-05D-30.50**

Designation	DCN	DCX	Outer tube		Drill head			
			Designation	Dia. (mm)	OAL	LF	DCONMS	H
FNBM-03D-xx.xx	25	26.4	OT03	23.5	73	70	21	22
FNBM-04D-xx.xx	26.41	28.7	OT04	26	78	75	23.5	23
FNBM-05D-xx.xx	28.71	31	OT05	28	78	75	25.5	24
FNBM-06D-xx.xx	31.01	33.3	OT06	30.5	83	80	28	27
FNBM-07D-xx.xx	33.31	36.2	OT07	33	93	90	30	29
FNBM-08D-xx.xx	36.21	39.6	OT08	35.5	99	95	33	32
FNBM-09D-xx.xx	39.61	43	OT09	39	104	100	36	35
FNBM-10D-xx.xx	43.01	47	OT10	42.5	104	100	39	38
FNBM-11D-xx.xx	47.01	51.7	OT11	46.5	114	110	43	41
FNBM-12D-xx.xx	51.71	56.2	OT12	51	120	115	47	46
FNBM-13D-xx.xx	56.21	60.99	OT13	55.5	120	115	51	50
FNBM-13D-xx.xx	61	65	OT13	55.5	120	115	51	55

STANDARD CUTTING CONDITIONS

See more information

e-catalog



Reference pages: Spare parts → **J124**, Inserts → **J126 - J127**, Guide pads → **J128**, Drill tube (DTS) → **J160**



SPARE PARTS

Tool diameter DCN - DCX (mm)	Insert									Guide pad		
	① Peripheral			② Intermediate			③ Central			④		
	Insert	Screw*	Wrench	Insert	Screw*	Wrench	Insert	Screw*	Wrench	Guide pad	Screw	Wrench
25 - 28	FBH0603**R**-P	CSTB-2.2	T-7F	FBM060304R**-I	CSTB-2.2	T-7F	FBM060308L**-C	CSTB-2.2	T-7F	GP06	CSTB-2.2S	T-7F
28.01 - 29.99	FBH0603**R**-P	CSTB-2.2	T-7F	FBM060304R**-I	CSTB-2.2	T-7F	FBM070408L**-C	SR14-560-HG	T-8F	GP06	CSTB-2.2S	T-7F
30 - 35	FBH0804**R**-P	SR14-560-HG	T-8F	FBM070404R**-I	SR14-560-HG	T-8F	FBM070408L**-C	SR14-560-HG	T-8F	GP07	CSTB-3S	T-9F
35.01 - 38	FBH0804**R**-P	SR14-560-HG	T-8F	FBM070404R**-I	SR14-560-HG	T-8F	FBM080408L**-C	SR14-560-HG	T-8F	GP07	CSTB-3S	T-9F
38.01 - 39	FBH0904**R**-P	SR14-560-HG	T-8F	FBM070404R**-I	SR14-560-HG	T-8F	FBM080408L**-C	SR14-560-HG	T-8F	GP07	CSTB-3S	T-9F
39.01 - 41	FBH0904**R**-P	SR14-560-HG	T-8F	FBM070404R**-I	SR14-560-HG	T-8F	FBM080408L**-C	SR14-560-HG	T-8F	GP08	CSTB-3S	T-9F
41.01 - 44	FBH0904**R**-P	SR14-560-HG	T-8F	FBM080404R**-I	SR14-560-HG	T-8F	FBM080408L**-C	SR14-560-HG	T-8F	GP08	CSTB-3S	T-9F
44.01 - 45	FBH0904**R**-P	SR14-560-HG	T-8F	FBM080404R**-I	SR14-560-HG	T-8F	FBM100408L**-C	SR14-560-HG	T-8F	GP08	CSTB-3S	T-9F
45.01 - 47	FBH0904**R**-P	SR14-560-HG	T-8F	FBM080404R**-I	SR14-560-HG	T-8F	FBM100408L**-C	SR14-560-HG	T-8F	GP10S	CSTB-3.5	T-15F
47.01 - 51	FBH1104**R**-P	SR14-560-HG	T-8F	FBM080404R**-I	SR14-560-HG	T-8F	FBM100408L**-C	SR14-560-HG	T-8F	GP10S	CSTB-3.5	T-15F
51.01 - 54	FBH1104**R**-P	SR14-560-HG	T-8F	FBM100404R**-I	SR14-560-HG	T-8F	FBM100408L**-C	SR14-560-HG	T-8F	GP10S	CSTB-3.5	T-15F
54.01 - 57	FBH1104**R**-P	SR14-560-HG	T-8F	FBM100404R**-I	SR14-560-HG	T-8F	FBM130408L**-C	SR14-560-HG	T-8F	GP10S	CSTB-3.5	T-15F
57.01 - 60	FBH1104**R**-P	SR14-560-HG	T-8F	FBM100404R**-I	SR14-560-HG	T-8F	FBM130408L**-C	SR14-560-HG	T-8F	GP12	CSTB-3.5	T-15F
60.01 - 64	FBH1304**R**-P	SR14-560-HG	T-8F	FBM100404R**-I	SR14-560-HG	T-8F	FBM130408L**-C	SR14-560-HG	T-8F	GP12	CSTB-3.5	T-15F
64.01 - 65	FBH1304**R**-P	SR14-560-HG	T-8F	FBM130404R**-I	SR14-560-HG	T-8F	FBM130408L**-C	SR14-560-HG	T-8F	GP12	CSTB-3.5	T-15F

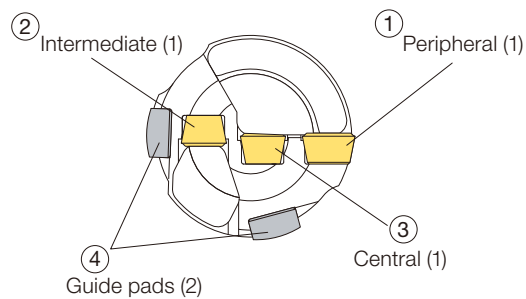
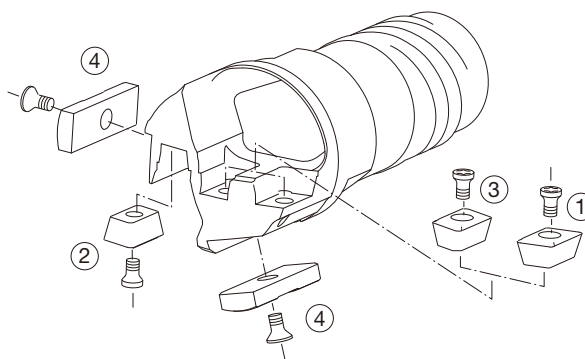

Tool diameter DCN - DCX (mm)	Insert												Guide pad					
	① Peripheral			② Intermediate			③ Intermediate			④ Intermediate			⑤ Central			⑥		
	Insert	Screw*	Wrench	Insert	Screw*	Wrench	Insert	Screw*	Wrench	Insert	Screw*	Wrench	Insert	Screw*	Wrench	Guide pad	Screw	Wrench
65.01 - 71	FBH1104**R**-P	SR 14-560-HG	T-8F	FBM070404R**-I	SR 14-560-HG	T-8F	FBM080404R**-I	SR 14-560-HG	T-8F	FBM080404R**-I	SR 14-560-HG	T-8F	FBM100408L**-C	SR 14-560-HG	T-8F	GP12	CSTB-3.5	T-15F
71.01 - 83	FBH1304**R**-P	SR 14-560-HG	T-8F	FBM080404R**-I	SR 14-560-HG	T-8F	FBM080404R**-I	SR 14-560-HG	T-8F	FBM080404R**-I	SR 14-560-HG	T-8F	FBM100408L**-C	SR 14-560-HG	T-8F	GP12	CSTB-3.5	T-15F
83.01 - 89	FBH1304**R**-P	SR 14-560-HG	T-8F	FBM080404R**-I	SR 14-560-HG	T-8F	FBM100404R**-I	SR 14-560-HG	T-8F	FBM080404R**-I	SR 14-560-HG	T-8F	FBM130408L**-C	SR 14-560-HG	T-8F	GP12	CSTB-3.5	T-15F

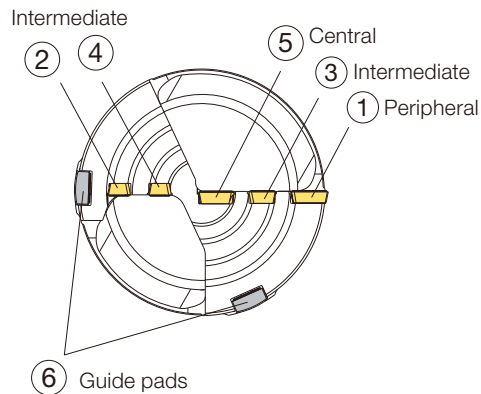
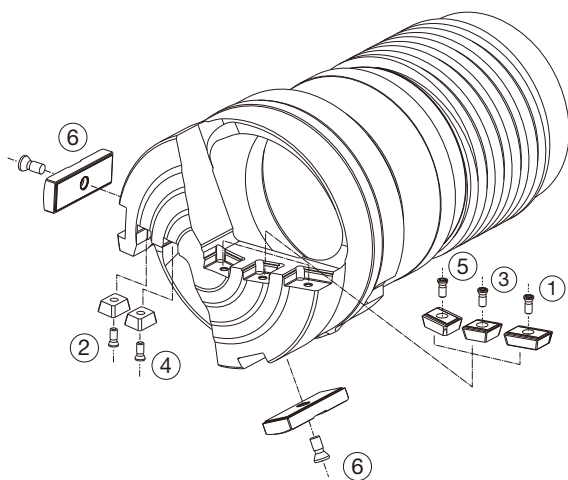

*See page J125 on size variation of the insert clamping screws.

Drill heads come with clamping screws and wrenches but do not include inserts and guide pads. Please purchase inserts and guide pads separately.

Recommended clamping torque: CSTB-2.2/CSTB-2.2S = 1 N·m, SR14-560-HG = 1.2 N·m, CSTB-2.5 = 1.3 N·m, CSTB-3S = 2.3 N·m, CSTB-3.5 = 3.5 N·m

CAUTION

To improve its performance, the FineBeam drill head has undergone design changes. The new drill head has a **guide pad protector**, as shown below, that protects the guide pad from being damaged when retrieving the drill from the hole into the guide bushing after completing machining. Accordingly, the insert clamping screw design for drill head diameters of 30 mm or greater has also been changed. See the list below for details.

When ordering insert clamping screws, below before choosing the screw size, first confirm the drill body design according to the procedure shown.

→ If the drill head has the protector: **Use a screw in the new design**

→ If the drill head has NO protector: **Use a screw in the previous design**

New design

With guide pad protector

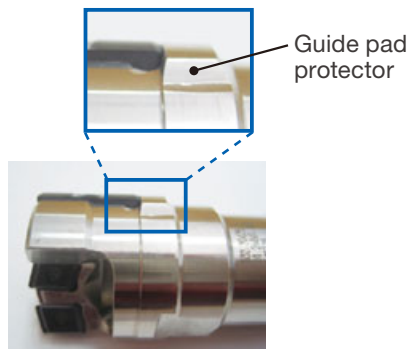

Conventional design

Without guide pad protector

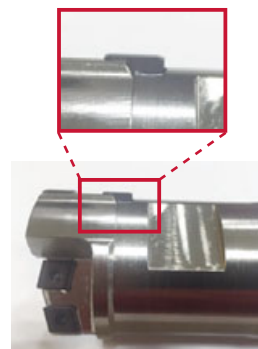

Tool diameter DCN - DCX (mm)	Peripheral insert		Intermediate insert		Central insert	
	Screw		Screw		Screw	
	New	Conventional	New	Conventional	New	Conventional
25 - 28	CSTB-2.2	CSTB-2.2	CSTB-2.2	CSTB-2.2	CSTB-2.2	CSTB-2.2
28.01 - 29.99	CSTB-2.2	CSTB-2.2	CSTB-2.2	CSTB-2.2	CSTB-2.2	CSTB-2.2
30 - 35	SR14-560-HG	CSTB2.5	SR14-560-HG	CSTB2.5	SR14-560-HG	CSTB2.5
35.01 - 38	SR14-560-HG	CSTB2.5	SR14-560-HG	CSTB2.5	SR14-560-HG	CSTB2.5
38.01 - 39	SR14-560-HG	CSTB2.5	SR14-560-HG	CSTB2.5	SR14-560-HG	CSTB2.5
39.01 - 41	SR14-560-HG	CSTB2.5	SR14-560-HG	CSTB2.5	SR14-560-HG	CSTB2.5
41.01 - 44	SR14-560-HG	CSTB2.5	SR14-560-HG	CSTB2.5	SR14-560-HG	CSTB2.5
44.01 - 45	SR14-560-HG	CSTB2.5	SR14-560-HG	CSTB2.5	SR14-560-HG	CSTB2.5
45.01 - 47	SR14-560-HG	CSTB2.5	SR14-560-HG	CSTB2.5	SR14-560-HG	CSTB2.5
47.01 - 51	SR14-560-HG	CSTB2.5	SR14-560-HG	CSTB2.5	SR14-560-HG	CSTB2.5
51.01 - 54	SR14-560-HG	CSTB2.5	SR14-560-HG	CSTB2.5	SR14-560-HG	CSTB2.5
54.01 - 57	SR14-560-HG	CSTB2.5	SR14-560-HG	CSTB2.5	SR14-560-HG	CSTB2.5
57.01 - 60	SR14-560-HG	CSTB2.5	SR14-560-HG	CSTB2.5	SR14-560-HG	CSTB2.5
60.01 - 64	SR14-560-HG	CSTB2.5	SR14-560-HG	CSTB2.5	SR14-560-HG	CSTB2.5
64.01 - 65	SR14-560-HG	CSTB2.5	SR14-560-HG	CSTB2.5	SR14-560-HG	CSTB2.5

The two types of screws are not interchangeable. A wrong screw will not fit the drill head body. Please contact your dealer for further information.

INSERT

FBM-C (Central insert)

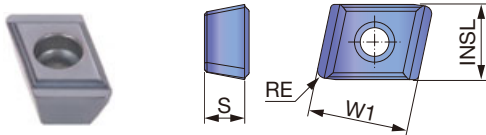

P	Steel	★	☆	☆
M	Stainless	★	☆	☆
K	Cast iron	★	☆	☆
N	Non-ferrous	★	☆	☆
S	Superalloys	☆	☆	★
H	Hard materials	☆	☆	★

★ : First choice
☆ : Second choice

Designation	INSL	W1	Coated			S	DCN	DCX	RE
			AH9130	AH725	AH8015				
FBM060308L-G-C	5.5	8	●	●	●	3	25	28	0.8
FBM060308L-HF-C	5.5	8	●	●	●	3	25	28	0.8
FBM070408L-G-C	6.5	10	●	●	●	4	28.1	35	0.8
FBM070408L-HF-C	6.5	10	●	●	●	4	28.1	35	0.8
FBM080408L-G-C	8	10	●	●	●	4	35.01	44	0.8
FBM080408L-HF-C	8	10	●	●	●	4	35.01	44	0.8
FBM100408L-G-C	9.5	10	●	●	●	4	44.01	54	0.8
FBM100408L-HF-C	9.5	10	●	●	●	4	44.01	54	0.8
FBM130408L-G-C	12.5	10	●	●	●	4	54.01	65	0.8
FBM130408L-HF-C	12.5	10	●	●	●	4	54.01	65	0.8

● : Line up

FBM-I (Intermediate insert)

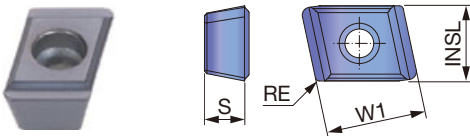

P	Steel	★	☆	☆
M	Stainless	★	☆	☆
K	Cast iron	★	☆	☆
N	Non-ferrous	★	☆	☆
S	Superalloys	☆	☆	★
H	Hard materials	☆	☆	★

★ : First choice
☆ : Second choice

Designation	INSL	W1	Coated			S	DCN	DCX	RE
			AH9130	AH725	AH8015				
FBM060304R-DL-I	5.5	8	●	●	●	3	25	29.99	0.4
FBM060304R-G-I	5.5	8	●	●	●	3	25	29.99	0.4
FBM060304R-HF-I	5.5	8	●	●	●	3	25	29.99	0.4
FBM070404R-DL-I	6.5	10	●	●	●	4	30	41	0.4
FBM070404R-G-I	6.5	10	●	●	●	4	30	41	0.4
FBM070404R-HF-I	6.5	10	●	●	●	4	30	41	0.4
FBM080404R-G-I	8	10	●	●	●	4	41.01	51	0.4
FBM080404R-HF-I	8	10	●	●	●	4	41.01	51	0.4
FBM100404R-G-I	9.5	10	●	●	●	4	51.01	64	0.4
FBM100404R-HF-I	9.5	10	●	●	●	4	51.01	64	0.4
FBM130404R-G-I	12.5	10	●	●	●	4	64.01	65	0.4
FBM130404R-HF-I	12.5	10	●	●	●	4	64.01	65	0.4

● : Line up

FBH-P (Peripheral insert)

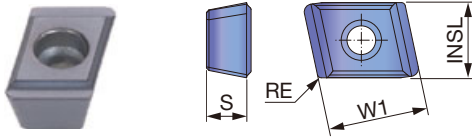

P	Steel	★	☆	☆	☆
M	Stainless	★	☆	☆	☆
K	Cast iron	★	☆	☆	☆
N	Non-ferrous	★	☆	☆	☆
S	Superalloys	☆	☆	☆	★
H	Hard materials	☆	☆	☆	★

★ : First choice
☆ : Second choice

Designation	INSL	W1	Coated				S	DCN	DCX	RE
			AH9130	AH725	UC3120	AH8015				
FBH060304R-G-P	6	8	●	▲			3	25	29.99	0.4
FBH060308R-G-P	6	8	●	●	●		3	25	29.99	0.8
FBH060308R-HF-P	6	8	●	●	●		3	25	29.99	0.8
FBH080404R-G-P	7.5	10	●	▲			4	30	38	0.4
FBH080408R-G-P	7.5	10	●	●	●		4	30	38	0.8
FBH080408R-HF-P	7.5	10	●	●	●		4	30	38	0.8
FBH090404R-G-P	9	10	●	▲			4	38.01	47	0.4
FBH090408R-G-P	9	10	●	●	●		4	38.01	47	0.8
FBH090408R-HF-P	9	10	●	●	●		4	38.01	47	0.8
FBH110408R-G-P	11	10	●	●	●		4	47.01	60	0.8
FBH110408R-HF-P	11	10	●	●	●		4	47.01	60	0.8
FBH130408R-G-P	13	10	●	●	●		4	60.01	65	0.8
FBH130408R-HF-P	13	10	●	●	●		4	60.01	65	0.8

● : Line up
▲ : To be discontinued

Chipbreaker comparison

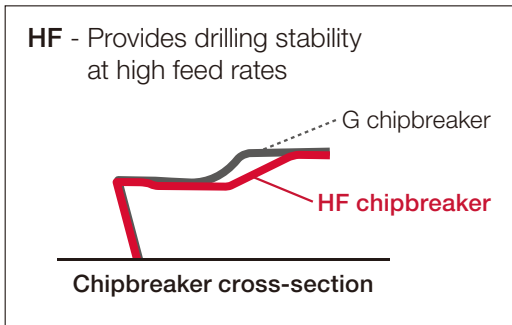

Insert grade

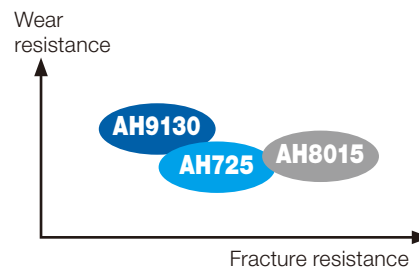

GUIDE PAD

GP06, 07, 08, 10S, 12

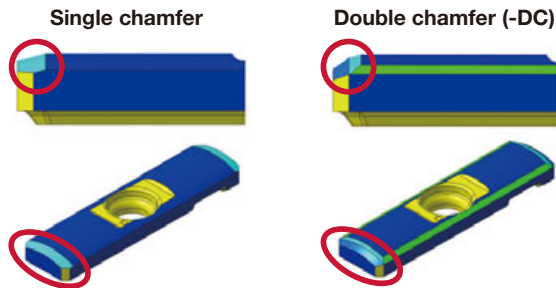
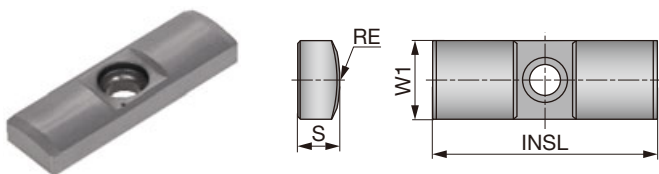

Designation	DCN	DCX	Coated			W1	INSL	S	RE	Chamfer
			F1122	FH3125	FH3135					
GP06	25	29.99	●			6	20	3	12	Single
GP06-20-120-DC	25	29.99		●	●	6	20	3	12	Double
GP07	30	39	●			7	20	3.5	12	Single
GP07-20-120-DC	30	39		●	●	7	20	3.5	12	Double
GP08	39.01	45	●			8	25	4.5	15.5	Single
GP08-25-155-DC	39.01	45		●	●	8	25	4.5	15.5	Double
GP10S	45.01	57	●			10	30	4.5	20	Single
GP10-30-200-DC	45.01	57		●	●	10	30	4.5	20	Double
GP12	57.01	89	●			12	35	5.5	25	Single
GP12-35-250-DC	57.01	89		●	●	12	35	5.5	25	Double

●: Line up
 Package quantity = 5 pcs.

Grade recommendations

ISO	Oil coolant			Water based coolant		
	First choice	Second choice	Third choice	First choice	Second choice	Third choice
P	FH3125	F1122	FH3135	FH3135	FH3125	-
M	FH3135	FH3125	F1122	FH3135	FH3125	-
K	FH3125	F1122	FH3135	FH3135	FH3125	-
N	FH3125	F1122	FH3135	FH3135	FH3125	-
S	FH3135	FH3125	F1122	FH3135	FH3125	-
H	FH3135	FH3125	F1122	FH3135	FH3125	-

Indexable drill head with external 4-start thread for single tube system (STS), diameters adjustable, tool diameter $\varnothing 38.00 - \varnothing 106.99$ mm, CICT = 3

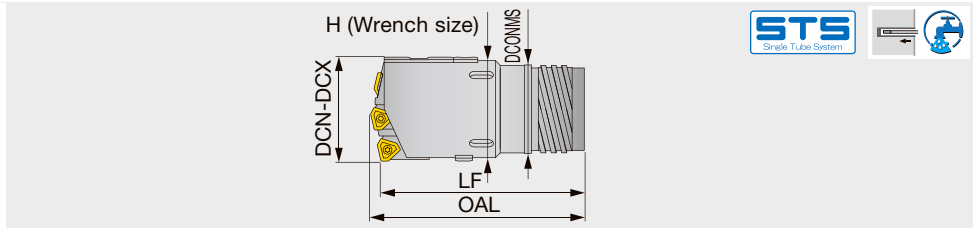

Standard products

Designation	DC	CICT	Drill tube		Drill head			
			Designation	Dia. (mm)	OAL	LF	DCONMS	H
KUSTS17E-80.00	80	3	ST17	75	190	180	70	83
KUSTS18E-90.00	90	3	ST18	82	191	180	77	96
KUSTS19E-100.00	100	3	ST19	94	192	180	89	102

Non-standard products (to be supplied on request)

When ordering

KUSTS**E

Drill head

-

XX.XX

Diameter (mm)

e.g. Designation for tool diameter $\varnothing 60$ mm: **KUSTS12E-60.00**

Designation	DCN	DCX	CICT	Drill tube		Drill head			
				Designation	Dia. (mm)	OAL	LF	DCONMS	H
KUSTS07E-xx.xx	38	39.6	3	ST07	33	90	85	30	37
KUSTS08E-xx.xx	39.61	43	3	ST08	36	91	85	33	40
KUSTS09E-xx.xx	43.01	47	3	ST09	39	101	95	36	43
KUSTS10E-xx.xx	47.01	51.7	3	ST10	43	102	95	39	48
KUSTS11E-xx.xx	51.71	56.2	3	ST11	47	107	100	43	52
KUSTS12E-xx.xx	56.21	60.6	3	ST12	51	118	110	47	57
KUSTS13E-xx.xx	60.61	65	3	ST13	56	119	110	51	61
KUSTS14E-xx.xx	65	66.99	3	ST14	56	159	150	52	63
KUSTS15E-xx.xx	67	72.99	3	ST15	62	159	150	58	69
KUSTS16E-xx.xx	73	79.99	3	ST16	68	160	150	63	76
KUSTS17E-xx.xx	80	86.99	3	ST17	75	190	180	70	83
KUSTS18E-xx.xx	87	99.99	3	ST18	82	191	180	77	96
KUSTS19E-xx.xx	100	106.99	3	ST19	94	192	180	89	102

For drill heads in diameters of $\varnothing 92$ mm or larger, a filler is attached in place of guide pad. Before drilling operation, please adjust drill diameter. For diameter adjustment please see page **L102**.

STANDARD CUTTING CONDITIONS

See more information

e-catalog



UNIDEX STS

UNIDEX STS-IN

Indexable drill head with internal single-start thread for single tube system (STS), diameters adjustable, tool diameter $\varnothing 38.00 - \varnothing 106.99$ mm, CICT = 3

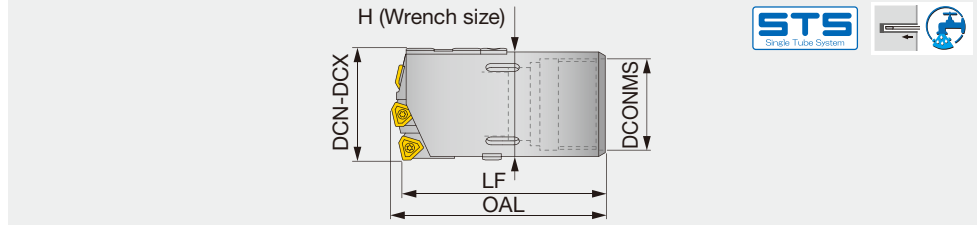

Non-standard products (to be supplied on request)

When ordering

KUSTS - XX.XX**

Drill head

Diameter (mm)

e.g. Designation for tool diameter $\varnothing 60$ mm: **KUSTS51-60.00**

Designation	DCN	DCX	CICT	Drill tube		Drill head			
				Designation	Dia. (mm)	OAL	LF	DCONMS	H
KUSTS33-xx.xx	38	39.99	3	UB33	33	85	80	30	37
KUSTS36-xx.xx	40	43.99	3	UB36	36	86	80	33	41
KUSTS39-xx.xx	44	46.99	3	UB39	39	96	90	37	43
KUSTS43-xx.xx	47	51.99	3	UB43	43	97	90	41	48
KUSTS47-xx.xx	52	56.99	3	UB47	47	107	100	44	53
KUSTS51-xx.xx	57	60.99	3	UB51	51	118	110	49	57
KUSTS56-xx.xx	61	67.99	3	UB56	56	119	110	53	64
KUSTS62-xx.xx	68	74.99	3	UB62	62	129	120	59	71
KUSTS68-xx.xx	75	80.99	3	UB68	68	161	150	65	77
KUSTS75-xx.xx	81	90.99	3	UB75	75	162	150	71	87
KUSTS82-xx.xx	91	98.99	3	UB82	82	162	150	79	95
KUSTS94-xx.xx	99	106.99	3	UB94	94	163	150	90	102

For drill heads in diameters of $\varnothing 92$ mm or larger, a filler is attached in place of guide pad.
Before drilling operation, please adjust drill diameter. For diameter adjustment please see page **L102**.

INSERTS

Tool diameter DCN-DCX (mm)	Peripheral insert	Qty	Intermediate insert	Qty	Central insert	Qty
38 - 39.99	NPMX08**R...	1	NPMX08**R...	1	NPMX08**R...	1
40 - 44.99	TPMX14**R...	1	NPMX08**R...	1	NPMX08**R...	1
45 - 47.99	TPMX14**R...	1	NPMX08**R...	1	TPMX14**R...	1
48 - 51.99	TPMX14**R...	1	TPMX14**R...	1	TPMX14**R...	1
52 - 54.99	TPMX17**R...	1	TPMX14**R...	1	TPMX14**R...	1
55 - 57.99	TPMX17**R...	1	TPMX14**R...	1	TPMX17**R...	1
58 - 59.99	TPMX17**R...	1	TPMX17**R...	1	TPMX17**R...	1
60 - 63.99	TPMX17**R...	1	TPMX17**R...	1	TPMX17**R...	1
64 - 67.99	TPMX24**R...	1	TPMX17**R...	1	TPMX17**R...	1
68 - 77.99	TPMX17**R...	1	TPMX24**R...	1	TPMX24**R...	1
78 - 84.99	TPMX24**R...	1	TPMX24**R...	1	TPMX24**R...	1
85 - 91.99	TPMX28**R...	1	TPMX24**R...	1	TPMX24**R...	1
92 - 98.99	TPMX24**R...	1	TPMX28**R...	1	TPMX28**R...	1
99 - 106.99	TPMX28**R...	1	TPMX28**R...	1	TPMX28**R...	1

⊕ **Plus:** The drill diameter can be increased by up to 5 mm by using the Plus parts. A maximum expandable diameter is determined by the peripheral cartridge size used on the drill. See page **J149** for details.

Drill heads come with cartridge, guide pad, filler, protector, sub guide pad and wrench, but do not include inserts.

STANDARD CUTTING CONDITIONS

See more information

e-catalog



Reference pages: Spare parts → **J131**, Inserts → **J146**, Guide pads → **J147**, Drill tube (STS) → **J158**

SPARE PARTS

Tool diameter DCN-DCX (mm)	Cartridge			Guide pad							
	Peripheral	Intermediate	Central	Guide pad		Filler		Protector		Sub guide pad	
	Cartridge ①	Cartridge ②	Cartridge ③	④	Qty	⑤	Qty	⑥	Qty	⑦	Qty
38 - 39.99	OZ05R	IOZ05R	IOZ05R	GP08	2	-	-	GPT08	2	CUG08	1
40 - 44.99	OZ402 - 04	IOZ05R	IOZ05R	GP08	2	-	-	GPT08	2	CUG08	1
45 - 47.99	OZ402 - 04	IOZ05R	IOZ402 - 04	GP10	2	-	-	GPT10	2	CUG08	1
48 - 51.99	OZ402 - 04	IOZ402 - 04	IOZ402 - 04	GP10	2	-	-	GPT10	2	CUG08	1
52 - 54.99	OZ402 - 32	IOZ402 - 04	IOZ402 - 04	GP10	2	-	-	GPT10	2	CUG08	1
55 - 57.99	OZ402 - 32	IOZ402 - 04	IOZ402 - 32	GP10	2	-	-	GPT10	2	CUG08	1
58 - 59.99	OZ402 - 32	IOZ402 - 32	IOZ402 - 32	GP10	2	-	-	GPT10	2	CUG08	1
60 - 63.99	OZ402 - 32	IOZ402 - 32	IOZ402 - 32	GP14	2	-	-	GPT14	2	CUG08	1
64 - 67.99	OZ402 - 43	IOZ402 - 32	IOZ402 - 32	GP14	2	-	-	GPT14	2	CUG10	1
68 - 77.99	OZ402 - 32	IOZ402 - 43	IOZ402 - 43	GP14	2	-	-	GPT14	2	CUG10	1
78 - 84.99	OZ402 - 43	IOZ402 - 43	IOZ402 - 43	GP14	2	-	-	GPT14	2	CUG10	1
85 - 91.99	OZ402 - 63	IOZ402 - 43	IOZ402 - 43	GP14	2	-	-	GPT14	2	CUG10	1
92 - 98.99	OZ402 - 43	IOZ402 - 63	IOZ402 - 63	GP14	2	FILLER14	1	GPT14	2	CUG10	1
99 - 106.99	OZ402 - 63	IOZ402 - 63	IOZ402 - 63	GP18	2	FL18 - M	1	GPT18 - M	2	CUG14 - M	1

See page L101 on handling of filler.

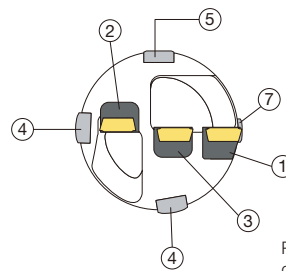
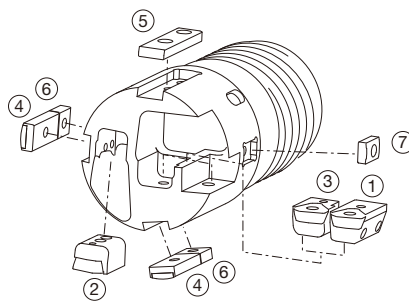

Part positions may vary depending on the drill size.

SCREWS, WRENCHES (CICT = 3)

Tool diameter DCN-DCX (mm)	Insert screw					
	Peripheral		Intermediate		Central	
	Cartridge ①		Cartridge ②		Cartridge ③	
	Screw	Wrench	Screw	Wrench	Screw	Wrench
38 - 39.99	CSTB-2.2	T-7D	CSTB-2.2	T-7D	CSTB-2.2	T-7D
40 - 44.99	CSTB-2.5	T-8D	CSTB-2.2	T-7D	CSTB-2.2	T-7D
45 - 47.99	CSTB-2.5	T-8D	CSTB-2.2	T-7D	CSTB-2.5	T-8D
48 - 51.99	CSTB-2.5	T-8D	CSTB-2.5	T-8D	CSTB-2.5	T-8D
52 - 54.99	CSTB-3.5D	T-9D	CSTB-2.5	T-8D	CSTB-2.5	T-8D
55 - 57.99	CSTB-3.5D	T-9D	CSTB-2.5	T-8D	CSTB-3.5D	T-9D
58 - 59.99	CSTB-3.5D	T-9D	CSTB-3.5D	T-9D	CSTB-3.5D	T-9D
60 - 63.99	CSTB-3.5D	T-9D	CSTB-3.5D	T-9D	CSTB-3.5D	T-9D
64 - 67.99	CSTB-4M	T-15D	CSTB-3.5D	T-9D	CSTB-3.5D	T-9D
68 - 77.99	CSTB-3.5D	T-9D	CSTB-4M	T-15D	CSTB-4M	T-15D
78 - 84.99	CSTB-4M	T-15D	CSTB-4M	T-15D	CSTB-4M	T-15D
85 - 91.99	CSTB-5	T-20D	CSTB-4M	T-15D	CSTB-4M	T-15D
92 - 98.99	CSTB-4M	T-15D	CSTB-5	T-20D	CSTB-5	T-20D
99 - 106.99	CSTB-5	T-20D	CSTB-5	T-20D	CSTB-5	T-20D

SCREWS, WRENCHES (CICT = 3)

Tool diameter DCN-DCX (mm)	Cartridge screw						Guide pad screw					
	Peripheral		Intermediate		Central		Guide pad / Filler / Protector		Sub guide pad			
	Cartridge ①		Cartridge ②		Cartridge ③							
	Screw	Wrench	Adj. screw	Wrench	Screw	Wrench	Screw	Wrench	Screw	Wrench	Screw	Wrench
38 - 39.99	LS1803RH	H2	AS0003-5	H1.5	CSTB-3	T-9D	CSTB-3	T-9D	CSTB-3S	T-9D	CSTB-3S	T-9D
40 - 44.99	LS1803.5RH	H2.5	AS0004-8	H2	CSTB-3	T-9D	CSTB-3	T-9D	CSTB-3S	T-9D	CSTB-3S	T-9D
45 - 47.99	LS1803.5RH	H2.5	AS0004-8	H2	CSTB-3	T-9D	CSTB-3.5	T-9D	CSTB-4S	T-15D	CSTB-3S	T-9D
48 - 51.99	LS1803.5RH	H2.5	AS0004-8	H2	CSTB-3.5	T-15D	CSTB-3.5	T-15D	CSTB-4S	T-15D	CSTB-3S	T-9D
52 - 54.99	LS1805RH	H3	AS0005-10	H2.5	CSTB-3.5	T-15D	CSTB-3.5	T-15D	CSTB-4S	T-15D	CSTB-3S	T-9D
55 - 57.99	LS1805RH	H3	AS0005-10	H2.5	CSTB-3.5	T-15D	CSTA-5	T-15D	CSTB-4S	T-15D	CSTB-3S	T-9D
58 - 59.99	LS1805RH	H3	AS0005-10	H2.5	CSTA-5	T-15D	CSTA-5	T-15D	CSTB-4S	T-15D	CSTB-3S	T-9D
60 - 63.99	LS1805RH	H3	AS0005-10	H2.5	CSTA-5	T-15D	CSTA-5	T-15D	CSTA-5S	T-15D	CSTB-3S	T-9D
64 - 67.99	LS1806RH	H4	AS0005-15	H2.5	CSTA-5	T-15D	CSTA-5	T-15D	CSTA-5S	T-15D	CSTB-3S	T-9D
68 - 77.99	LS1805RH	H3	AS0005-10	H2.5	LS1206	H3	LS1206	H3	CSTA-5S	T-15D	CSTB-3S	T-9D
78 - 84.99	LS1806RH	H4	AS0005-15	H2.5	LS1206	H3	LS1206	H3	CSTA-5S	T-15D	CSTB-3S	T-9D
85 - 91.99	LS1806RH	H4	AS0006-15	H3	LS1206	H3	LS1206	H3	CSTA-5S	T-15D	CSTB-3S	T-9D
92 - 98.99	LS1806RH	H4	AS0005-15	H2.5	LS1206	H3	LS1206S	H3	CSTA-5S	T-15D	CSTB-3S	T-9D
99 - 106.99	LS1806RH	H4	AS0006-15	H3	LS1206	H3	LS1206S	H3	LS1206S	H3	CSTA-5S	T-15D

Recommended clamping torque: please see page J148.

UNIDEX STS

UNIDEX STS-EX

Indexable drill head with external 4-start thread for single tube system (STS), diameters adjustable, tool diameter $\varnothing 107.00 - \varnothing 168.99$ mm, CICT = 5

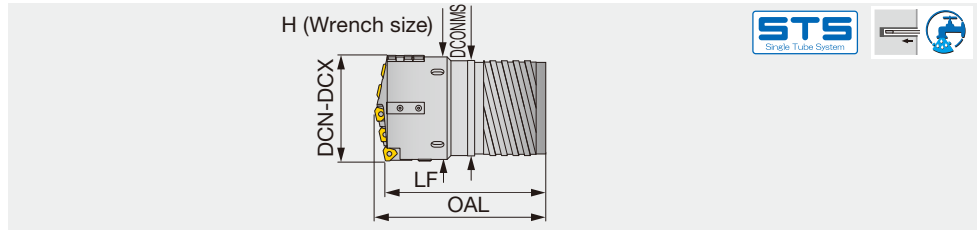

Non-standard products (to be supplied on request)

When ordering

KUSTSE - XX.XX**

Drill head

Diameter (mm)

e.g. Designation for tool diameter $\varnothing 150$ mm: KUSTS23E-150.00

Designation	DCN	DCX	CICT	Drill tube			Drill head		
				Designation	Dia. (mm)	OAL	LF	DCONMS	H
KUSTS19E-xx.xx	107	111.99	5	ST19	94	197	180	89	107
KUSTS20E-xx.xx	112	123.99	5	ST20	106	221	205	101	119
KUSTS21E-xx.xx	124	135.99	5	ST21	118	222	205	113	131
KUSTS22E-xx.xx	136	147.99	5	ST22	130	223	205	125	143
KUSTS23E-xx.xx	148	159.99	5	ST23	142	245	225	137	155
KUSTS24E-xx.xx	160	168.99	5	ST24	154	246	225	149	164

Before drilling operation, please adjust drill diameter. For diameter adjustment please see page **L102**.

STANDARD CUTTING CONDITIONS

See more information

e-catalog



Reference pages: Spare parts → **J134**, Inserts → **J146**, Guide pads → **J147**,
Drill tube (STS) → **J156**

UNIDEX STS-IN

Indexable drill head with internal single-start thread for single tube system (STS), diameters adjustable, tool diameter $\varnothing 107.00 - \varnothing 168.99$ mm, CICT = 5

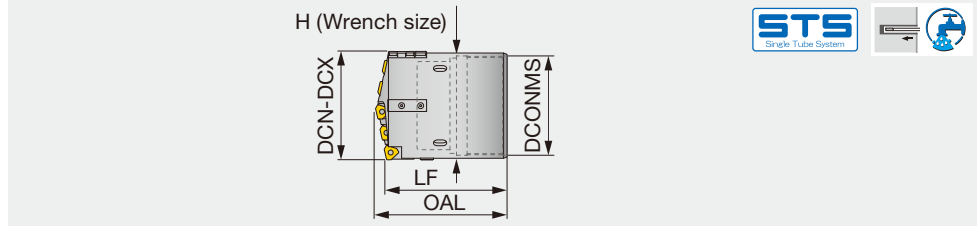

Non-standard products (to be supplied on request)

When ordering

KUSTS**	-	XX.XX
Drill head		Diameter (mm)

e.g. Designation for tool diameter $\varnothing 150$ mm: **KUSTS142-150.00**

Designation	DCN	DCX	CICT	Drill tube			Drill head		
				Designation	Dia. (mm)	OAL	LF	DCONMS	H
KUSTS94-xx.xx	107	110.99	5	UB94	94	164	150	90	106
KUSTS106-xx.xx	111	122.99	5	UB106	106	165	150	102	118
KUSTS118-xx.xx	123	134.99	5	UB118	118	167	150	114	130
KUSTS130-xx.xx	135	148.99	5	UB130	130	168	150	126	144
KUSTS142-xx.xx	149	161.99	5	UB142	142	170	150	139	157
KUSTS154-xx.xx	162	168.99	5	UB154	154	211	190	151	164

Before drilling operation, please adjust drill diameter. For diameter adjustment please see page **L102**.

INSERTS

Tool diameter DCN-DCX (mm)	Peripheral	Qty	Intermediate	Qty	Intermediate	Qty	Central	Qty
107.00 - 117.99	TPMX24**R...	1	TPMX17**R...	3	-	-	TPMX24**R...	1
118.00 - 135.99	TPMX24**R...	1	TPMX24**R...	3	-	-	TPMX24**R...	1
136.00 - 144.99	TPMX24**R...	1	TPMX24**R...	3	-	-	TPMX28**R...	1
145.00 - 150.99	TPMX24**R...	1	TPMX24**R...	2	TPMX28**R...	1	TPMX28**R...	1
151.00 - 156.99	TPMX28**R...	1	TPMX24**R...	2	TPMX28**R...	1	TPMX28**R...	1
157.00 - 162.99	TPMX28**R...	1	TPMX24**R...	1	TPMX28**R...	2	TPMX28**R...	1
163.00 - 168.99	TPMX28**R...	1	TPMX28**R...	3	-	-	TPMX28**R...	1

⊕ **Plus:** The drill diameter can be increased by up to 5 mm by using the Plus parts. A maximum expandable diameter is determined by the peripheral cartridge size used on the drill. See page **J149** for details.

Drill heads come with cartridge, guide pad, filler, protector, sub guide pad and wrench, but do not include inserts.

STANDARD CUTTING CONDITIONS

See more information

e-catalog



Reference pages: Spare parts → **J134**, Inserts → **J146**, Guide pads → **J147**,
Drill tube (STS) → **J158**



SPARE PARTS

Tool diameter DCN-DCX (mm)	Cartridge				
	Peripheral		Intermediate		Central
	Cartridge ①	Cartridge ②	Cartridge ③	Cartridge ④	Cartridge ⑤
107.00 - 117.99	OZ402 - 43	IOZ402 - 32	IOZ402 - 32	IOZ402 - 32	IOZ402 - 43
118.00 - 135.99	OZ402 - 43	IOZ402 - 43	IOZ402 - 43	IOZ402 - 43	IOZ402 - 43
136.00 - 144.99	OZ402 - 43	IOZ402 - 43	IOZ402 - 43	IOZ402 - 43	IOZ402 - 63
145.00 - 150.99	OZ402 - 43	IOZ402 - 43	IOZ402 - 63	IOZ402 - 43	IOZ402 - 63
151.00 - 156.99	OZ402 - 63	IOZ402 - 43	IOZ402 - 63	IOZ402 - 43	IOZ402 - 63
157.00 - 162.99	OZ402 - 63	IOZ402 - 43	IOZ402 - 63	IOZ402 - 63	IOZ402 - 63
163.00 - 168.99	OZ402 - 63	IOZ402 - 63	IOZ402 - 63	IOZ402 - 63	IOZ402 - 63

SPARE PARTS

Tool diameter DCN-DCX (mm)	Guide pad							
	Guide pad		Filler		Protector		Sub guide pad	
	⑥	Qty	⑦	Qty	⑧	Qty	⑨	Qty
107.00 - 117.99	GP18	2	FL18 - M	1	GPT18 - M	2	CUG14 - M	1
118.00 - 135.99	GP18	2	FL18 - M	1	GPT18 - M	2	CUG14 - M	1
136.00 - 144.99	GP18	4	FL18 - M	1	GPT18 - M	4	CUG14 - M	1
145.00 - 150.99	GP18	4	FL18 - M	1	GPT18 - M	4	CUG14 - M	1
151.00 - 156.99	GP18	4	FL18 - M	1	GPT18 - M	4	CUG14 - M	1
157.00 - 162.99	GP18	4	FL18 - M	1	GPT18 - M	4	CUG14 - M	1
163.00 - 168.99	GP18	4	FL18 - M	1	GPT18 - M	4	CUG14 - M	1

See page L101 on handling of filler.

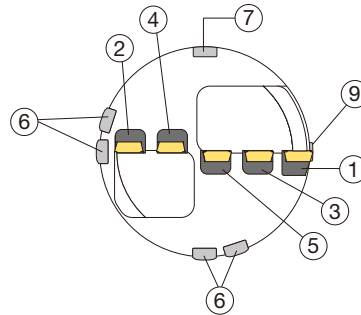
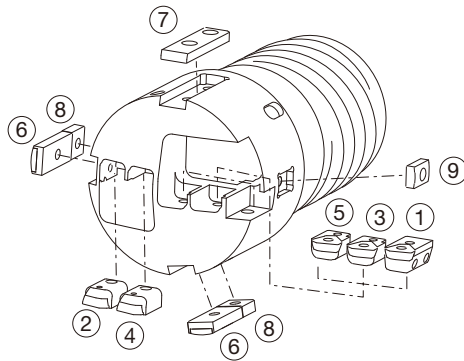

Part positions may vary depending on the drill size.

SCREWS, WRENCHES (CICT = 5)

Tool diameter DCN-DCX (mm)	Insert screw									
	Peripheral		Cartridge ②		Cartridge ③		Cartridge ④		Central	
	Screw	Wrench	Screw	Wrench	Screw	Wrench	Screw	Wrench	Screw	Wrench
107.00 - 117.99	CSTB-4M	T-15D	CSTB-3.5D	T-9D	CSTB-3.5D	T-9D	CSTB-3.5D	T-9D	CSTB-4M	T-15D
118.00 - 135.99	CSTB-4M	T-15D	CSTB-4M	T-15D	CSTB-4M	T-15D	CSTB-4M	T-15D	CSTB-4M	T-15D
136.00 - 144.99	CSTB-4M	T-15D	CSTB-4M	T-15D	CSTB-4M	T-15D	CSTB-4M	T-15D	CSTB-5	T-20D
145.00 - 150.99	CSTB-4M	T-15D	CSTB-4M	T-15D	CSTB-5	T-20D	CSTB-4M	T-15D	CSTB-5	T-20D
151.00 - 156.99	CSTB-5	T-20D	CSTB-4M	T-15D	CSTB-5	T-20D	CSTB-4M	T-15D	CSTB-5	T-20D
157.00 - 162.99	CSTB-5	T-20D	CSTB-4M	T-15D	CSTB-5	T-20D	CSTB-5	T-20D	CSTB-5	T-20D
163.00 - 168.99	CSTB-5	T-20D	CSTB-5	T-20D	CSTB-5	T-20D	CSTB-5	T-20D	CSTB-5	T-20D

SCREWS, WRENCHES (CICT = 5)

Tool diameter DCN-DCX (mm)	Cartridge screw								Guide pad screw			
	Peripheral				Intermediate		Central		Guide pad / Filler / Protector		Sub guide pad	
	Cartridge ①		Cartridge ② - ④		Cartridge ⑤		Screw		Screw		Wrench	
107.00 - 117.99	LS1806RH	H4	AS0005-15	H2.5	CSTA-5	T-15D	LS1206	H3	LS1206S	H3	CSTA-5S	T-15D
118.00 - 135.99	LS1806RH	H4	AS0005-15	H2.5	LS1206	H3	LS1206	H3	LS1206SSS	H3	CSTA-5S	T-15D
136.00 - 144.99	LS1806RH	H4	AS0005-15	H2.5	LS1206	H3	LS1206S	H3	LS1206SSS	H3	CSTA-5S	T-15D
145.00 - 150.99	LS1806RH	H4	AS0005-15	H2.5	LS1206	H3	LS1206S	H3	LS1206SSS	H3	CSTA-5S	T-15D
151.00 - 156.99	LS1806RH	H4	AS0006-15	H3	LS1206	H3L	LS1206S	H3L	LS1206S	H3	CSTA-5S	T-15D
157.00 - 162.99	LS1806RH	H4	AS0006-15	H3	LS1206	H3L	LS1206S	H3L	LS1206S	H3	CSTA-5S	T-15D
163.00 - 168.99	LS1806RH	H4	AS0006-15	H3	LS1206	H3L	LS1206S	H3L	LS1206S	H3	CSTA-5S	T-15D

Recommended clamping torque: please see page J148.

Indexable drill head with external 4-start thread for single tube system (STS), diameters adjustable, tool diameter $\varnothing 169.00 - \varnothing 232.99$ mm, CICT = 7

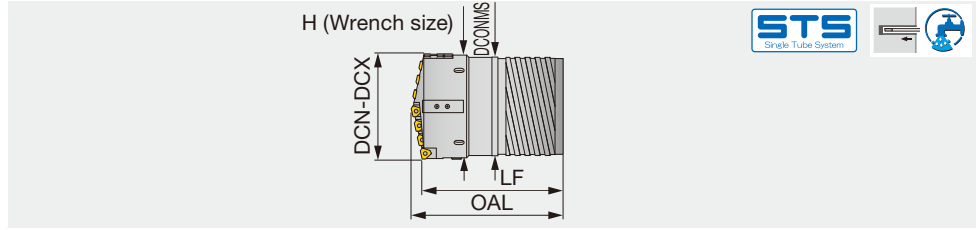

Non-standard products (to be supplied on request)

When ordering

KUSTSE - XX.XX**

Drill head - Diameter (mm)

e.g. Designation for tool diameter $\varnothing 185$ mm: KUSTS26E-185.00

Designation	DCN	DCX	CICT	Drill tube			Drill head		
				Designation	Dia. (mm)	OAL	LF	DCONMS	H
KUSTS24E-xx.xx	169	171.99	7	ST24	154	246	225	149	167
KUSTS25E-xx.xx	172	183.99	7	ST25	166	247	225	161	179
KUSTS26E-xx.xx	184	195.99	7	ST26	178	267	245	173	191
KUSTS27E-xx.xx	196	207.99	7	ST27	190	270	245	185	203
KUSTS28E-xx.xx	208	219.99	7	ST28	202	271	245	197	215
KUSTS29E-xx.xx	220	231.99	7	ST29	214	293	265	208	227
KUSTS30E-xx.xx	232	232.99	7	ST30	226	293	265	220	228

Before drilling operation, please adjust drill diameter. For diameter adjustment please see page L102.

STANDARD CUTTING CONDITIONS

See more information

e-catalog



Indexable drill head with internal single-start thread for single tube system (STS), diameters adjustable, tool diameter $\varnothing 169.00 - \varnothing 232.99$ mm, CICT = 7

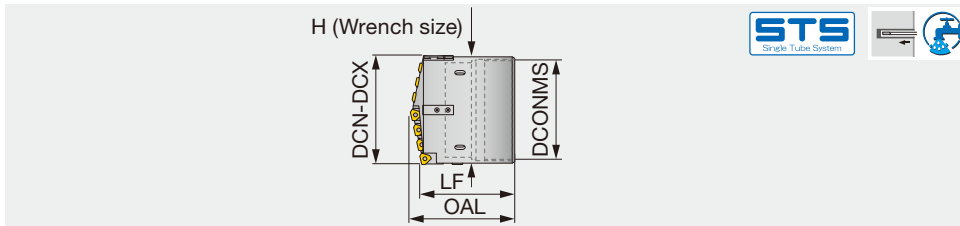

Non-standard products (to be supplied on request)

When ordering

KUSTS - XX.XX**

Drill head

Diameter (mm)

e.g. Designation for tool diameter $\varnothing 185$ mm: **KUSTS166-185.00**

Designation	DCN	DCX	CICT	Drill tube			Drill head		
				Designation	Dia. (mm)	OAL	LF	DCONMS	H
KUSTS154-xx.xx	169	173.99	7	UB154	154	211	190	151	169
KUSTS166-xx.xx	174	185.99	7	UB166	166	213	190	163	181
KUSTS178-xx.xx	186	197.99	7	UB178	178	212	190	175	193
KUSTS190-xx.xx	198	209.99	7	UB190	190	215	190	187	205
KUSTS202-xx.xx	210	221.99	7	UB202	202	217	190	199	217
KUSTS214-xx.xx	222	232.99	7	UB214	214	218	190	211	228

Before drilling operation, please adjust drill diameter. For diameter adjustment please see page **L102**.

INSERTS

Tool diameter DCN-DCX (mm)	Peripheral	Qty	Intermediate	Qty	Intermediate	Qty	Central	Qty
169.00 - 188.99	TPMX24**R...	1	TPMX24**R...	5	-	-	TPMX24**R...	1
189.00 - 196.99	TPMX24**R...	1	TPMX24**R...	5	-	-	TPMX28**R...	1
197.00 - 202.99	TPMX24**R...	1	TPMX24**R...	4	TPMX28**R...	1	TPMX28**R...	1
203.00 - 208.99	TPMX24**R...	1	TPMX24**R...	3	TPMX28**R...	2	TPMX28**R...	1
209.00 - 214.99	TPMX28**R...	1	TPMX24**R...	3	TPMX28**R...	2	TPMX28**R...	1
215.00 - 220.99	TPMX28**R...	1	TPMX24**R...	2	TPMX28**R...	3	TPMX28**R...	1
221.00 - 226.99	TPMX28**R...	1	TPMX24**R...	1	TPMX28**R...	4	TPMX28**R...	1
227.00 - 232.99	TPMX28**R...	1	TPMX28**R...	5	-	-	TPMX28**R...	1

⊕ **Plus:** The drill diameter can be increased by up to 5 mm by using the Plus parts. A maximum expandable diameter is determined by the peripheral cartridge size used on the drill. See page **J149** for details.

Drill heads come with cartridge, guide pad, filler, protector, sub guide pad and wrench, but do not include inserts.

STANDARD CUTTING CONDITIONS

See more information

e-catalog



Reference pages: Spare parts → **J137**, Inserts → **J146**, Guide pads → **J147**,
Drill tube (STS) → **J158**

SPARE PARTS



Tool diameter DCN-DCX (mm)	Cartridge						
	Peripheral	Intermediate					Central
	Cartridge ①	Cartridge ②	Cartridge ③	Cartridge ④	Cartridge ⑤	Cartridge ⑥	Cartridge ⑦
169.00 - 188.99	OZ402 - 43	IOZ402 - 43	IOZ402 - 43	IOZ402 - 43	IOZ402 - 43	IOZ402 - 43	IOZ402 - 43
189.00 - 196.99	OZ402 - 43	IOZ402 - 43	IOZ402 - 43	IOZ402 - 43	IOZ402 - 43	IOZ402 - 43	IOZ402 - 63
197.00 - 202.99	OZ402 - 43	IOZ402 - 43	IOZ402 - 43	IOZ402 - 43	IOZ402 - 63	IOZ402 - 43	IOZ402 - 63
203.00 - 208.99	OZ402 - 43	IOZ402 - 43	IOZ402 - 63	IOZ402 - 43	IOZ402 - 63	IOZ402 - 43	IOZ402 - 63
209.00 - 214.99	OZ402 - 63	IOZ402 - 43	IOZ402 - 63	IOZ402 - 43	IOZ402 - 63	IOZ402 - 43	IOZ402 - 63
215.00 - 220.99	OZ402 - 63	IOZ402 - 43	IOZ402 - 63	IOZ402 - 43	IOZ402 - 63	IOZ402 - 63	IOZ402 - 63
221.00 - 226.99	OZ402 - 63	IOZ402 - 43	IOZ402 - 63	IOZ402 - 63	IOZ402 - 63	IOZ402 - 63	IOZ402 - 63
227.00 - 232.99	OZ402 - 63	IOZ402 - 63	IOZ402 - 63	IOZ402 - 63	IOZ402 - 63	IOZ402 - 63	IOZ402 - 63

SPARE PARTS



Tool diameter DCN-DCX (mm)	Guide pad							
	Guide pad		Filler		Protector		Sub guide pad	
	⑧	Qty	⑨	Qty	⑩	Qty	⑪	Qty
169.00 - 188.99	GP18	4	FL18 - M	1	GPT18 - M	4	CUG14 - M	1
189.00 - 196.99	GP18	4	FL18 - M	1	GPT18 - M	4	CUG14 - M	1
197.00 - 202.99	GP18	4	FL18 - M	1	GPT18 - M	4	CUG14 - M	1
203.00 - 208.99	GP18	4	FL18 - M	1	GPT18 - M	4	CUG14 - M	1
209.00 - 214.99	GP18	4	FL18 - M	1	GPT18 - M	4	CUG14 - M	1
215.00 - 220.99	GP18	4	FL18 - M	1	GPT18 - M	4	CUG14 - M	1
221.00 - 226.99	GP18	4	FL18 - M	1	GPT18 - M	4	CUG14 - M	1
227.00 - 232.99	GP18	4	FL18 - M	1	GPT18 - M	4	CUG14 - M	1

See page L101 on handling of filler.

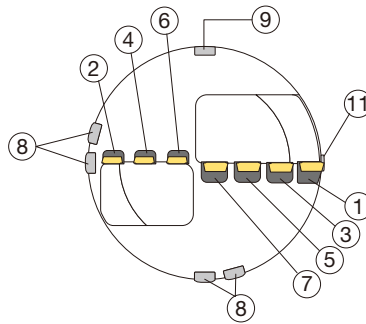
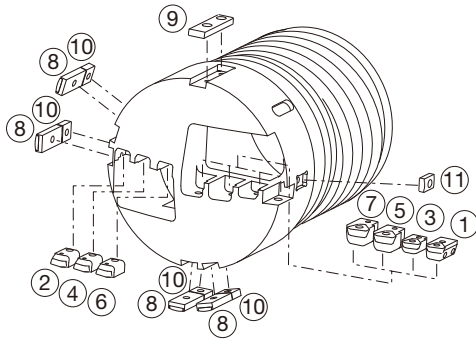

Part positions may vary depending on the drill size.

**SCREWS, WRENCHES
(CICT = 7)**



Tool diameter DCN-DCX (mm)	Insert screw													
	Peripheral		Intermediate				Central							
	Cartridge ①		Cartridge ②		Cartridge ③		Cartridge ④		Cartridge ⑤		Cartridge ⑥		Cartridge ⑦	
	Screw	Wrench	Screw	Wrench	Screw	Wrench	Screw	Wrench	Screw	Wrench	Screw	Wrench	Screw	Wrench
169.00 - 188.99	CSTB-4M	T-15D	CSTB-4M	T-15D	CSTB-4M	T-15D	CSTB-4M	T-15D	CSTB-4M	T-15D	CSTB-4M	T-15D	CSTB-4M	T-15D
189.00 - 196.99	CSTB-4M	T-15D	CSTB-4M	T-15D	CSTB-4M	T-15D	CSTB-4M	T-15D	CSTB-4M	T-15D	CSTB-4M	T-15D	CSTB-5	T-20D
197.00 - 202.99	CSTB-4M	T-15D	CSTB-4M	T-15D	CSTB-4M	T-15D	CSTB-4M	T-15D	CSTB-5	T-20D	CSTB-4M	T-15D	CSTB-5	T-20D
203.00 - 208.99	CSTB-4M	T-15D	CSTB-4M	T-15D	CSTB-5	T-20D	CSTB-4M	T-15D	CSTB-5	T-20D	CSTB-4M	T-15D	CSTB-5	T-20D
209.00 - 214.99	CSTB-5	T-20D	CSTB-4M	T-15D	CSTB-5	T-20D	CSTB-4M	T-15D	CSTB-5	T-20D	CSTB-4M	T-15D	CSTB-5	T-20D
215.00 - 220.99	CSTB-5	T-20D	CSTB-4M	T-15D	CSTB-5	T-20D	CSTB-4M	T-15D	CSTB-5	T-20D	CSTB-5	T-20D	CSTB-5	T-20D
221.00 - 226.99	CSTB-5	T-20D	CSTB-4M	T-15D	CSTB-5	T-20D	CSTB-5	T-20D	CSTB-5	T-20D	CSTB-5	T-20D	CSTB-5	T-20D
227.00 - 232.99	CSTB-5	T-20D	CSTB-5	T-20D	CSTB-5	T-20D	CSTB-5	T-20D	CSTB-5	T-20D	CSTB-5	T-20D	CSTB-5	T-20D

**SCREWS, WRENCHES
(CICT = 7)**



Tool diameter DCN-DCX (mm)	Cartridge screw								Guide pad screw			
	Peripheral		Intermediate		Central		Guide pad / Filler / Protector		Sub guide pad			
	Cartridge ①		Cartridge ② - ⑥		Cartridge ⑦							
	Screw	Wrench	Adj. screw	Wrench	Screw	Wrench	Screw	Wrench	Screw	Wrench	Screw	Wrench
169.00 - 188.99	LS1806RH	H4	AS0005-15	H2.5	LS1206	H3L	LS1206	H3L	LS1206SSS	H3	CSTA-5S	T-15D
189.00 - 196.99	LS1806RH	H4	AS0005-15	H2.5	LS1206	H3L	LS1206S	H3L	LS1206SSS	H3	CSTA-5S	T-15D
197.00 - 202.99	LS1806RH	H4	AS0005-15	H2.5	LS1206	H3L	LS1206S	H3L	LS1206SSS	H3	CSTA-5S	T-15D
203.00 - 208.99	LS1806RH	H4	AS0005-15	H2.5	LS1206	H3L	LS1206S	H3L	LS1206SSS	H3	CSTA-5S	T-15D
209.00 - 214.99	LS1806RH	H4	AS0006-15	H3	LS1206	H3L	LS1206S	H3L	LS1206S	H3	CSTA-5S	T-15D
215.00 - 220.99	LS1806RH	H4	AS0006-15	H3	LS1206	H3L	LS1206S	H3L	LS1206S	H3	CSTA-5S	T-15D
221.00 - 226.99	LS1806RH	H4	AS0006-15	H3	LS1206	H3L	LS1206S	H3L	LS1206S	H3	CSTA-5S	T-15D
227.00 - 232.99	LS1806RH	H4	AS0006-15	H3	LS1206	H3L	LS1206S	H3L	LS1206S	H3	CSTA-5S	T-15D

Recommended clamping torque: please see page J148.

Grade
Insert
Ext. Toolholder
Int. Toolholder
Threading
Grooving
Milling cutter
Miniature tool
Endmill
Drilling tool
Tooling System
User's Guide
Index



Indexable drill head with external 4-start thread for single tube system (STS), diameters adjustable, tool diameter $\varnothing 233.00 - \varnothing 291.99$ mm, CICT = 9

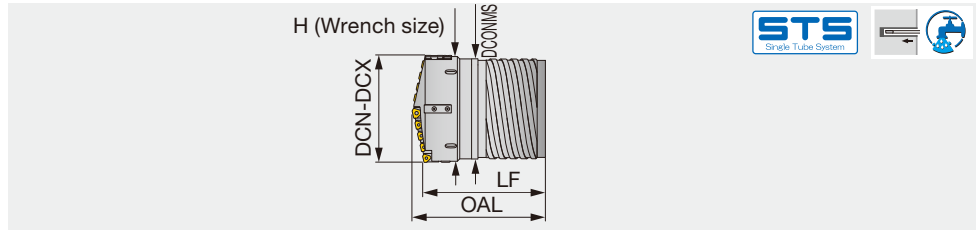

Non-standard products (to be supplied on request)

When ordering

KUSTSE - XX.XX**

Drill head

Diameter (mm)

e.g. Designation for tool diameter $\varnothing 240$ mm: KUSTS30E-240.00

Designation	DCN	DCX	CICT	Drill tube			Drill head		
				Designation	Dia. (mm)	OAL	LF	DCONMS	H
KUSTS30E-xx.xx	233	243.99	9	ST30	226	294	265	220	239
KUSTS31E-xx.xx	244	255.99	9	ST31	238	294	265	232	251
KUSTS32E-xx.xx	256	267.99	9	ST32	250	322	290	244	263
KUSTS33E-xx.xx	268	279.99	9	ST33	262	323	290	256	275
KUSTS34E-xx.xx	280	291.99	9	ST34	274	325	290	268	287

Before drilling operation, please adjust drill diameter. For diameter adjustment please see page [L102](#).
Larger sizes available upon request. Please contact your dealer for further information.

STANDARD CUTTING CONDITIONS

See more information

e-catalog



Reference pages: Spare parts → [J140](#), Inserts → [J139](#), [J146](#), Guide pads → [J147](#),
Drill tube (STS) → [J156](#)

UNIDEX STS-IN

Indexable drill head with internal single-start thread for single tube system (STS), diameters adjustable, tool diameter $\varnothing 233.00 - \varnothing 293.99$ mm, CICT = 9

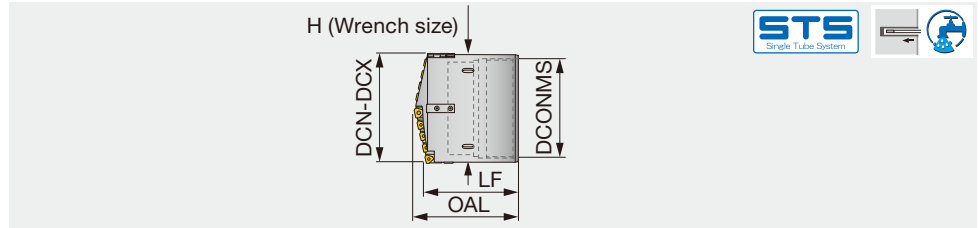

Non-standard products (to be supplied on request)

When ordering

KUSTS**	-	XX.XX
Drill head		Diameter (mm)

e.g. Designation for tool diameter $\varnothing 240$ mm: **KUSTS226-240.00**

Designation	DCN	DCX	CICT	Drill tube			Drill head		
				Designation	Dia. (mm)	OAL	LF	DCONMS	H
KUSTS214-xx.xx	233	233.99	9	UB214	214	217	190	211	229
KUSTS226-xx.xx	234	245.99	9	UB226	226	219	190	223	241
KUSTS238-xx.xx	246	257.99	9	UB238	238	221	190	235	253
KUSTS250-xx.xx	258	269.99	9	UB250	250	242	210	245	265
KUSTS262-xx.xx	270	281.99	9	UB262	262	244	210	259	277
KUSTS274-xx.xx	282	293.99	9	UB274	274	245	210	271	289

Before drilling operation, please adjust drill diameter. For diameter adjustment please see page **L102**.
Larger sizes available upon request. Please contact your dealer for further information.

INSERTS

Tool diameter DCN-DCX (mm)	Peripheral	Qty	Intermediate	Qty	Intermediate	Qty	Central	Qty
233.00 - 247.99	TPMX24**R...	1	TPMX24**R...	7	-	-	TPMX28**R...	1
248.00 - 253.99	TPMX28**R...	1	TPMX24**R...	7	-	-	TPMX28**R...	1
254.00 - 258.99	TPMX28**R...	1	TPMX24**R...	6	TPMX28**R...	1	TPMX28**R...	1
259.00 - 264.99	TPMX28**R...	1	TPMX24**R...	5	TPMX28**R...	2	TPMX28**R...	1
265.00 - 271.99	TPMX28**R...	1	TPMX24**R...	4	TPMX28**R...	3	TPMX28**R...	1
272.00 - 275.99	TPMX28**R...	1	TPMX24**R...	3	TPMX28**R...	4	TPMX28**R...	1
276.00 - 284.99	TPMX28**R...	1	TPMX24**R...	2	TPMX28**R...	5	TPMX28**R...	1
285.00 - 289.99	TPMX28**R...	1	TPMX24**R...	1	TPMX28**R...	6	TPMX28**R...	1
290.00 - 293.99	TPMX28**R...	1	TPMX28**R...	7	-	-	TPMX28**R...	1

⊕ **Plus:** The drill diameter can be increased by up to 5 mm by using the Plus parts. A maximum expandable diameter is determined by the peripheral cartridge size used on the drill. See page **J149** for details.
Drill heads come with cartridge, guide pad, filler, protector, sub guide pad and wrench, but do not include inserts.

STANDARD CUTTING CONDITIONS

See more information

e-catalog



Reference pages: Spare parts → **J140**, Inserts → **J146**, Guide pads → **J147**,
Drill tube (STS) → **J158**



SPARE PARTS

Tool diameter DCN-DCX (mm)	Cartridge							
	Peripheral	Intermediate						
	Cartridge ①	Cartridge ②	Cartridge ③	Cartridge ④	Cartridge ⑤	Cartridge ⑥	Cartridge ⑦	Cartridge ⑧
233.00 - 247.99	OZ402 - 43	IOZ402 - 43	IOZ402 - 43	IOZ402 - 43	IOZ402 - 43	IOZ402 - 43	IOZ402 - 43	IOZ402 - 43
248.00 - 253.99	OZ402 - 63	IOZ402 - 43	IOZ402 - 43	IOZ402 - 43	IOZ402 - 43	IOZ402 - 43	IOZ402 - 43	IOZ402 - 43
254.00 - 258.99	OZ402 - 63	IOZ402 - 43	IOZ402 - 43	IOZ402 - 43	IOZ402 - 43	IOZ402 - 43	IOZ402 - 63	IOZ402 - 43
259.00 - 264.99	OZ402 - 63	IOZ402 - 43	IOZ402 - 43	IOZ402 - 43	IOZ402 - 63	IOZ402 - 43	IOZ402 - 63	IOZ402 - 43
265.00 - 271.99	OZ402 - 63	IOZ402 - 43	IOZ402 - 63	IOZ402 - 43	IOZ402 - 63	IOZ402 - 43	IOZ402 - 63	IOZ402 - 43
272.00 - 275.99	OZ402 - 63	IOZ402 - 43	IOZ402 - 63	IOZ402 - 43	IOZ402 - 63	IOZ402 - 43	IOZ402 - 63	IOZ402 - 63
276.00 - 284.99	OZ402 - 63	IOZ402 - 43	IOZ402 - 63	IOZ402 - 43	IOZ402 - 63	IOZ402 - 63	IOZ402 - 63	IOZ402 - 63
285.00 - 289.99	OZ402 - 63	IOZ402 - 43	IOZ402 - 63	IOZ402 - 63	IOZ402 - 63	IOZ402 - 63	IOZ402 - 63	IOZ402 - 63
290.00 - 293.99	OZ402 - 63	IOZ402 - 63	IOZ402 - 63	IOZ402 - 63	IOZ402 - 63	IOZ402 - 63	IOZ402 - 63	IOZ402 - 63

SPARE PARTS

Tool diameter DCN-DCX (mm)	Cartridge	Guide pad							
	Central	Guide pad		Filler		Protector		Sub guide pad	
	Cartridge ⑨	⑩	Qty	⑪	Qty	⑫	Qty	⑬	Qty
233.00 - 247.99	IOZ402 - 63	GP18	4	FL18 - M	1	GPT18 - M	4	CUG14 - M	1
248.00 - 253.99	IOZ402 - 63	GP18	4	FL18 - M	1	GPT18 - M	4	CUG14 - M	1
254.00 - 258.99	IOZ402 - 63	GP18	4	FL18 - M	1	GPT18 - M	4	CUG14 - M	1
259.00 - 264.99	IOZ402 - 63	GP18	4	FL18 - M	1	GPT18 - M	4	CUG14 - M	1
265.00 - 271.99	IOZ402 - 63	GP18	4	FL18 - M	1	GPT18 - M	4	CUG14 - M	1
272.00 - 275.99	IOZ402 - 63	GP18	4	FL18 - M	1	GPT18 - M	4	CUG14 - M	1
276.00 - 284.99	IOZ402 - 63	GP18	4	FL18 - M	1	GPT18 - M	4	CUG14 - M	1
285.00 - 289.99	IOZ402 - 63	GP18	4	FL18 - M	1	GPT18 - M	4	CUG14 - M	1
290.00 - 293.99	IOZ402 - 63	GP18	4	FL18 - M	1	GPT18 - M	4	CUG14 - M	1

See page L101 on handling of filler.

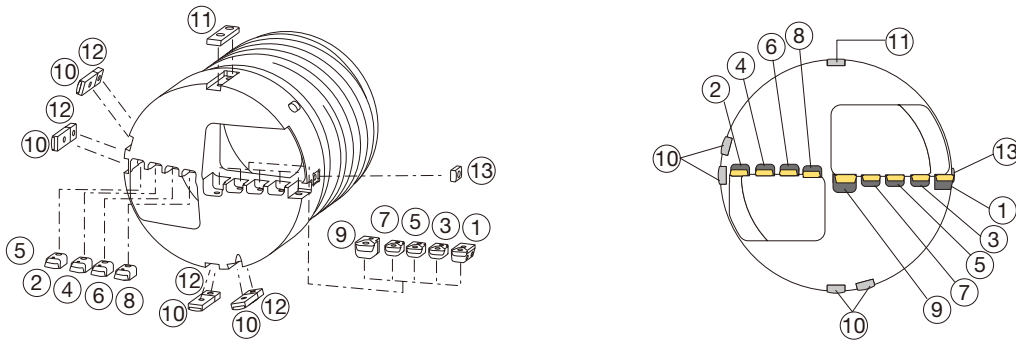

Part positions may vary depending on the drill size.

SCREWS, WRENCHES (CICT = 9)

Tool diameter DCN-DCX (mm)	Insert screw																			
	Peripheral		Intermediate														Central			
	Cartridge ①		Cartridge ②	Cartridge ③	Cartridge ④	Cartridge ⑤	Cartridge ⑥	Cartridge ⑦	Cartridge ⑧	Cartridge ⑧	Cartridge ⑧	Cartridge ⑧	Cartridge ⑧	Cartridge ⑧	Cartridge ⑧	Cartridge ⑧	Cartridge ⑧	Cartridge ⑧	Cartridge ⑨	
233.00 - 247.99	CSTB-4M	T-15D	CSTB-4M	T-15D	CSTB-4M	T-15D	CSTB-4M	T-15D	CSTB-4M	T-15D	CSTB-4M	T-15D	CSTB-4M	T-15D	CSTB-4M	T-15D	CSTB-4M	T-15D	CSTB-5	T-20D
248.00 - 253.99	CSTB-5	T-20D	CSTB-4M	T-15D	CSTB-4M	T-15D	CSTB-4M	T-15D	CSTB-4M	T-15D	CSTB-4M	T-15D	CSTB-4M	T-15D	CSTB-4M	T-15D	CSTB-4M	T-15D	CSTB-5	T-20D
254.00 - 258.99	CSTB-5	T-20D	CSTB-4M	T-15D	CSTB-4M	T-15D	CSTB-4M	T-15D	CSTB-4M	T-15D	CSTB-4M	T-15D	CSTB-5	T-20D	CSTB-4M	T-15D	CSTB-5	T-20D	CSTB-5	T-20D
259.00 - 264.99	CSTB-5	T-20D	CSTB-4M	T-15D	CSTB-4M	T-15D	CSTB-4M	T-15D	CSTB-5	T-20D	CSTB-4M	T-15D	CSTB-5	T-20D	CSTB-4M	T-15D	CSTB-5	T-20D	CSTB-5	T-20D
265.00 - 271.99	CSTB-5	T-20D	CSTB-4M	T-15D	CSTB-5	T-20D	CSTB-4M	T-15D	CSTB-5	T-20D	CSTB-4M	T-15D	CSTB-5	T-20D	CSTB-4M	T-15D	CSTB-5	T-20D	CSTB-5	T-20D
272.00 - 275.99	CSTB-5	T-20D	CSTB-4M	T-15D	CSTB-5	T-20D	CSTB-4M	T-15D	CSTB-5	T-20D	CSTB-4M	T-15D	CSTB-5	T-20D	CSTB-5	T-20D	CSTB-5	T-20D	CSTB-5	T-20D
276.00 - 284.99	CSTB-5	T-20D	CSTB-4M	T-15D	CSTB-5	T-20D	CSTB-4M	T-15D	CSTB-5	T-20D	CSTB-5	T-20D	CSTB-5	T-20D	CSTB-5	T-20D	CSTB-5	T-20D	CSTB-5	T-20D
285.00 - 289.99	CSTB-5	T-20D	CSTB-4M	T-15D	CSTB-5	T-20D	CSTB-5	T-20D	CSTB-5	T-20D	CSTB-5	T-20D	CSTB-5	T-20D	CSTB-5	T-20D	CSTB-5	T-20D	CSTB-5	T-20D
290.00 - 293.99	CSTB-5	T-20D	CSTB-5	T-20D	CSTB-5	T-20D	CSTB-5	T-20D	CSTB-5	T-20D	CSTB-5	T-20D	CSTB-5	T-20D	CSTB-5	T-20D	CSTB-5	T-20D	CSTB-5	T-20D

SCREWS, WRENCHES (CICT = 9)

Tool diameter DCN-DCX (mm)	Cartridge screw										Guide pad screw			
	Peripheral		Intermediate				Central		Guide pad / Filler / Protector		Sub guide pad			
	Cartridge ①		Cartridge ② - ⑧				Cartridge ⑨							
233.00 - 247.99	LS1806RH	H4	AS0005-15	H2.5	LS1206	H3L	LS1206S	H3L	LS1206SSS	H3	CSTA-5S	T-15D		
248.00 - 253.99	LS1806RH	H4	AS0006-15	H3	LS1206	H3L	LS1206S	H3L	LS1206S	H3	CSTA-5S	T-15D		
254.00 - 258.99	LS1806RH	H4	AS0006-15	H3	LS1206	H3L	LS1206S	H3L	LS1206S	H3	CSTA-5S	T-15D		
259.00 - 264.99	LS1806RH	H4	AS0006-15	H3	LS1206	H3L	LS1206S	H3L	LS1206S	H3	CSTA-5S	T-15D		
265.00 - 271.99	LS1806RH	H4	AS0006-15	H3	LS1206	H3L	LS1206S	H3L	LS1206S	H3	CSTA-5S	T-15D		
272.00 - 275.99	LS1806RH	H4	AS0006-15	H3	LS1206	H3L	LS1206S	H3L	LS1206S	H3	CSTA-5S	T-15D		
276.00 - 284.99	LS1806RH	H4	AS0006-15	H3	LS1206	H3L	LS1206S	H3L	LS1206S	H3	CSTA-5S	T-15D		
285.00 - 289.99	LS1806RH	H4	AS0006-15	H3	LS1206	H3L	LS1206S	H3L	LS1206S	H3	CSTA-5S	T-15D		
290.00 - 293.99	LS1806RH	H4	AS0006-15	H3	LS1206	H3L	LS1206S	H3L	LS1206S	H3	CSTA-5S	T-15D		

Recommended clamping torque: please see page J148.

Indexable drill head with external 4-start thread for double tube system (DTS), diameters adjustable, tool diameter $\varnothing 38.00 - \varnothing 106.99$ mm, CICT = 3

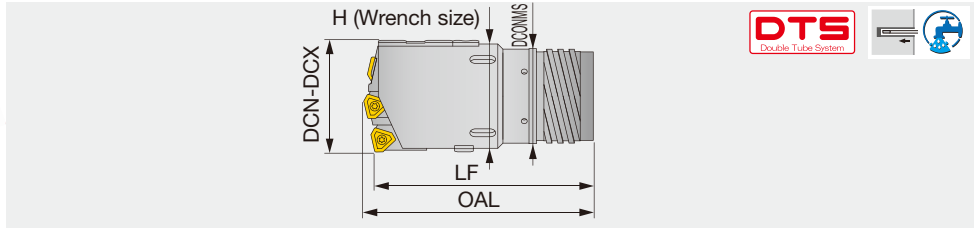

Non-standard products (to be supplied on request)

When ordering

KUDTSE - XX.XX**

Drill head - Diameter (mm)

e.g. Designation for tool diameter $\varnothing 60$ mm: **KUDTS13E-60.00**

Designation	DCN	DCX	CICT	Outer tube		Drill head			
				Designation	Dia. (mm)	OAL	LF	DCONMS	H
KUDTS08E-xx.xx	38	39.6	3	OT08	35.5	90	85	33	37
KUDTS09E-xx.xx	39.61	43	3	OT09	39	91	85	36	40
KUDTS10E-xx.xx	43.01	47	3	OT10	42.5	101	95	39	43
KUDTS11E-xx.xx	47.01	51.7	3	OT11	46.5	102	100	43	48
KUDTS12E-xx.xx	51.71	56.2	3	OT12	51	107	100	47	52
KUDTS13E-xx.xx	56.21	65	3	OT13	55.5	119	110	51	61
KUDTS14E-xx.xx	65	66.99	3	OT14	56	159	150	52	63
KUDTS15E-xx.xx	67	72.99	3	OT15	62	159	150	58	69
KUDTS16E-xx.xx	73	79.99	3	OT16	68	160	150	63	76
KUDTS17E-xx.xx	80	86.99	3	OT17	75	191	180	70	83
KUDTS18E-xx.xx	87	99.99	3	OT18	82	193	180	77	96
KUDTS19E-xx.xx	100	106.99	3	OT19	94	193	180	89	102

For drill heads in diameters of $\varnothing 92$ mm or larger, a filler is attached in place of guide pad.
Before drilling operation, please adjust drill diameter. For diameter adjustment please see page **L102**.

INSERTS

Tool diameter DCN-DCX (mm)	Peripheral insert	Qty	Intermediate insert	Qty	Central insert	Qty
38 - 39.99	NPMX08**R...	1	NPMX08**R...	1	NPMX08**R...	1
40 - 44.99	TPMX14**R...	1	NPMX08**R...	1	NPMX08**R...	1
45 - 47.99	TPMX14**R...	1	NPMX08**R...	1	TPMX14**R...	1
48 - 51.99	TPMX14**R...	1	TPMX14**R...	1	TPMX14**R...	1
52 - 54.99	TPMX17**R...	1	TPMX14**R...	1	TPMX14**R...	1
55 - 57.99	TPMX17**R...	1	TPMX14**R...	1	TPMX17**R...	1
58 - 59.99	TPMX17**R...	1	TPMX17**R...	1	TPMX17**R...	1
60 - 63.99	TPMX17**R...	1	TPMX17**R...	1	TPMX17**R...	1
64 - 67.99	TPMX24**R...	1	TPMX17**R...	1	TPMX17**R...	1
68 - 77.99	TPMX17**R...	1	TPMX24**R...	1	TPMX24**R...	1
78 - 84.99	TPMX24**R...	1	TPMX24**R...	1	TPMX24**R...	1
85 - 91.99	TPMX28**R...	1	TPMX24**R...	1	TPMX24**R...	1
92 - 98.99	TPMX24**R...	1	TPMX28**R...	1	TPMX28**R...	1
99 - 106.99	TPMX28**R...	1	TPMX28**R...	1	TPMX28**R...	1

⊕ **Plus:** The drill diameter can be increased by up to 5 mm by using the Plus parts. A maximum expandable diameter is determined by the peripheral cartridge size used on the drill. See page **J149** for details.
Drill heads come with cartridge, guide pad, filler, protector, sub guide pad and wrench, but do not include inserts.

STANDARD CUTTING CONDITIONS

See more information

e-catalog



Reference pages: Spare parts → **J142**, Inserts → **J146**, Guide pads → **J147**, Drill tube (STS) → **J160**



SPARE PARTS

Tool diameter DCN-DCX (mm)	Cartridge			Guide pad							
	Peripheral	Intermediate	Central	Guide pad		Filler		Protector		Sub guide pad	
	Cartridge ①	Cartridge ②	Cartridge ③	④	Qty	⑤	Qty	⑥	Qty	⑦	Qty
38 - 39.99	OZ05R	IOZ05R	IOZ05R	GP08	2	-	-	GPT08	2	CUG08	1
40 - 44.99	OZ402 - 04	IOZ05R	IOZ05R	GP08	2	-	-	GPT08	2	CUG08	1
45 - 47.99	OZ402 - 04	IOZ05R	IOZ402 - 04	GP10	2	-	-	GPT10	2	CUG08	1
48 - 51.99	OZ402 - 04	IOZ402 - 04	IOZ402 - 04	GP10	2	-	-	GPT10	2	CUG08	1
52 - 54.99	OZ402 - 32	IOZ402 - 04	IOZ402 - 04	GP10	2	-	-	GPT10	2	CUG08	1
55 - 57.99	OZ402 - 32	IOZ402 - 04	IOZ402 - 32	GP10	2	-	-	GPT10	2	CUG08	1
58 - 59.99	OZ402 - 32	IOZ402 - 32	IOZ402 - 32	GP10	2	-	-	GPT10	2	CUG08	1
60 - 63.99	OZ402 - 32	IOZ402 - 32	IOZ402 - 32	GP14	2	-	-	GPT14	2	CUG08	1
64 - 67.99	OZ402 - 43	IOZ402 - 32	IOZ402 - 32	GP14	2	-	-	GPT14	2	CUG10	1
68 - 77.99	OZ402 - 32	IOZ402 - 43	IOZ402 - 43	GP14	2	-	-	GPT14	2	CUG10	1
78 - 84.99	OZ402 - 43	IOZ402 - 43	IOZ402 - 43	GP14	2	-	-	GPT14	2	CUG10	1
85 - 91.99	OZ402 - 63	IOZ402 - 43	IOZ402 - 43	GP14	2	-	-	GPT14	2	CUG10	1
92 - 98.99	OZ402 - 43	IOZ402 - 63	IOZ402 - 63	GP14	2	FILLER14	1	GPT14	2	CUG10	1
99 - 106.99	OZ402 - 63	IOZ402 - 63	IOZ402 - 63	GP18	2	FL18 - M	1	GPT18 - M	2	CUG14 - M	1

See page L101 on handling of filler.

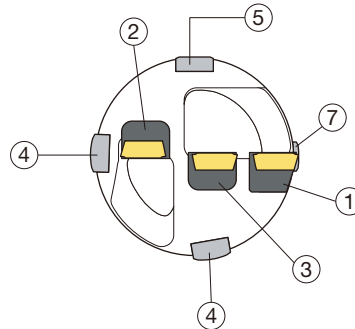
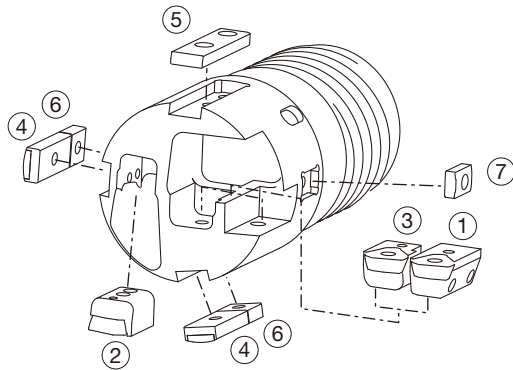

Part positions may vary depending on the drill size.

SCREWS, WRENCHES (CICT = 3)

Tool diameter DCN-DCX (mm)	Insert screw					
	Peripheral		Intermediate		Central	
	Cartridge ①		Cartridge ②		Cartridge ③	
	Screw	Wrench	Screw	Wrench	Screw	Wrench
38 - 39.99	CSTB-2.2	T-7D	CSTB-2.2	T-7D	CSTB-2.2	T-7D
40 - 44.99	CSTB-2.5	T-8D	CSTB-2.2	T-7D	CSTB-2.2	T-7D
45 - 47.99	CSTB-2.5	T-8D	CSTB-2.2	T-7D	CSTB-2.5	T-8D
48 - 51.99	CSTB-2.5	T-8D	CSTB-2.5	T-8D	CSTB-2.5	T-8D
52 - 54.99	CSTB-3.5D	T-9D	CSTB-2.5	T-8D	CSTB-2.5	T-8D
55 - 57.99	CSTB-3.5D	T-9D	CSTB-2.5	T-8D	CSTB-3.5D	T-9D
58 - 59.99	CSTB-3.5D	T-9D	CSTB-3.5D	T-9D	CSTB-3.5D	T-9D
60 - 63.99	CSTB-3.5D	T-9D	CSTB-3.5D	T-9D	CSTB-3.5D	T-9D
64 - 67.99	CSTB-4M	T-15D	CSTB-3.5D	T-9D	CSTB-3.5D	T-9D
68 - 77.99	CSTB-3.5D	T-9D	CSTB-4M	T-15D	CSTB-4M	T-15D
78 - 84.99	CSTB-4M	T-15D	CSTB-4M	T-15D	CSTB-4M	T-15D
85 - 91.99	CSTB-5	T-20D	CSTB-4M	T-15D	CSTB-4M	T-15D
92 - 98.99	CSTB-4M	T-15D	CSTB-5	T-20D	CSTB-5	T-20D
99 - 106.99	CSTB-5	T-20D	CSTB-5	T-20D	CSTB-5	T-20D

SCREWS, WRENCHES (CICT = 3)

Tool diameter DCN-DCX (mm)	Cartridge screw								Guide pad screw			
	Peripheral				Intermediate		Central		Guide pad / Filler / Protector		Sub guide pad	
	Cartridge ①				Cartridge ②		Cartridge ③					
	Screw	Wrench	Adj. screw	Wrench	Screw	Wrench	Screw	Wrench	Screw	Wrench	Screw	Wrench
38 - 39.99	LS1803RH	H2	AS0003-5	H1.5	CSTB-3	T-9D	CSTB-3	T-9D	CSTB-3S	T-9D	CSTB-3S	T-9D
40 - 44.99	LS1803.5RH	H2.5	AS0004-8	H2	CSTB-3	T-9D	CSTB-3	T-9D	CSTB-3S	T-9D	CSTB-3S	T-9D
45 - 47.99	LS1803.5RH	H2.5	AS0004-8	H2	CSTB-3	T-9D	CSTB-3.5	T-9D	CSTB-4S	T-15D	CSTB-3S	T-9D
48 - 51.99	LS1803.5RH	H2.5	AS0004-8	H2	CSTB-3.5	T-15D	CSTB-3.5	T-15D	CSTB-4S	T-15D	CSTB-3S	T-9D
52 - 54.99	LS1805RH	H3	AS0005-10	H2.5	CSTB-3.5	T-15D	CSTB-3.5	T-15D	CSTB-4S	T-15D	CSTB-3S	T-9D
55 - 57.99	LS1805RH	H3	AS0005-10	H2.5	CSTB-3.5	T-15D	CSTA-5	T-15D	CSTB-4S	T-15D	CSTB-3S	T-9D
58 - 59.99	LS1805RH	H3	AS0005-10	H2.5	CSTA-5	T-15D	CSTA-5	T-15D	CSTB-4S	T-15D	CSTB-3S	T-9D
60 - 63.99	LS1805RH	H3	AS0005-10	H2.5	CSTA-5	T-15D	CSTA-5	T-15D	CSTA-5S	T-15D	CSTB-3S	T-9D
64 - 67.99	LS1806RH	H4	AS0005-15	H2.5	CSTA-5	T-15D	CSTA-5	T-15D	CSTA-5S	T-15D	CSTB-3S	T-9D
68 - 77.99	LS1805RH	H3	AS0005-10	H2.5	LS1206	H3	LS1206	H3	CSTA-5S	T-15D	CSTB-3S	T-9D
78 - 84.99	LS1806RH	H4	AS0005-15	H2.5	LS1206	H3	LS1206	H3	CSTA-5S	T-15D	CSTB-3S	T-9D
85 - 91.99	LS1806RH	H4	AS0006-15	H3	LS1206	H3	LS1206	H3	CSTA-5S	T-15D	CSTB-3S	T-9D
92 - 98.99	LS1806RH	H4	AS0005-15	H2.5	LS1206	H3	LS1206S	H3	CSTA-5S	T-15D	CSTB-3S	T-9D
99 - 106.99	LS1806RH	H4	AS0006-15	H3	LS1206	H3	LS1206S	H3	LS1206S	H3	CSTA-5S	T-15D

Recommended clamping torque: please see page J148.

Indexable drill head with external 4-start thread for double tube system (DTS), diameters adjustable, tool diameter $\varnothing 107.00 - \varnothing 168.99$ mm, CICT = 5

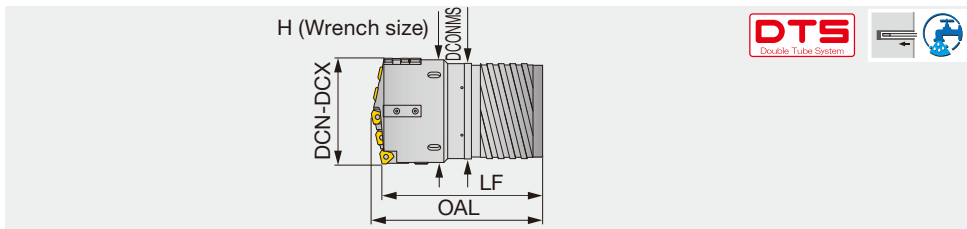

Non-standard products (to be supplied on request)

When ordering

KUDTSE - XX.XX**

Drill head - Diameter (mm)

e.g. Designation for tool diameter $\varnothing 150$ mm: KUDTS23E-150.00

Designation	DCN	DCX	CICT	Outer tube			Drill head		
				Designation	Dia. (mm)	OAL	LF	DCONMS	H
KUDTS19E-xx.xx	107	111.99	5	OT19	94	197	180	89	107
KUDTS20E-xx.xx	112	123.99	5	OT20	106	221	205	101	119
KUDTS21E-xx.xx	124	135.99	5	OT21	118	222	205	113	131
KUDTS22E-xx.xx	136	147.99	5	OT22	130	223	205	125	143
KUDTS23E-xx.xx	148	159.99	5	OT23	142	245	225	137	155
KUDTS24E-xx.xx	160	168.99	5	OT24	154	246	225	149	164

Before drilling operation, please adjust drill diameter. For diameter adjustment please see page L102.

INSERTS

Tool diameter DCN-DCX (mm)	Peripheral	Qty	Intermediate	Qty	Intermediate	Qty	Central	Qty
107.00 - 117.99	TPMX24**R...	1	TPMX17**R...	3	-	-	TPMX24**R...	1
118.00 - 135.99	TPMX24**R...	1	TPMX24**R...	3	-	-	TPMX24**R...	1
136.00 - 144.99	TPMX24**R...	1	TPMX24**R...	3	-	-	TPMX28**R...	1
145.00 - 150.99	TPMX24**R...	1	TPMX24**R...	2	TPMX28**R...	1	TPMX28**R...	1
151.00 - 156.99	TPMX28**R...	1	TPMX24**R...	2	TPMX28**R...	1	TPMX28**R...	1
157.00 - 162.99	TPMX28**R...	1	TPMX24**R...	1	TPMX28**R...	2	TPMX28**R...	1
163.00 - 168.99	TPMX28**R...	1	TPMX28**R...	3	-	-	TPMX28**R...	1

⊕ **Plus:** The drill diameter can be increased by up to 5 mm by using the Plus parts. A maximum expandable diameter is determined by the peripheral cartridge size used on the drill. See page J149 for details.

Drill heads come with cartridge, guide pad, filler, protector, sub guide pad and wrench, but do not include inserts.

STANDARD CUTTING CONDITIONS

See more information

e-catalog



SPARE PARTS

Tool diameter DCN-DCX (mm)	Cartridge				
	Peripheral	Intermediate			Central
	Cartridge ①	Cartridge ②	Cartridge ③	Cartridge ④	Cartridge ⑤
107.00 - 117.99	OZ402 - 43	IOZ402 - 32	IOZ402 - 32	IOZ402 - 32	IOZ402 - 43
118.00 - 135.99	OZ402 - 43	IOZ402 - 43	IOZ402 - 43	IOZ402 - 43	IOZ402 - 43
136.00 - 144.99	OZ402 - 43	IOZ402 - 43	IOZ402 - 43	IOZ402 - 43	IOZ402 - 63
145.00 - 150.99	OZ402 - 43	IOZ402 - 43	IOZ402 - 63	IOZ402 - 43	IOZ402 - 63
151.00 - 156.99	OZ402 - 63	IOZ402 - 43	IOZ402 - 63	IOZ402 - 43	IOZ402 - 63
157.00 - 162.99	OZ402 - 63	IOZ402 - 43	IOZ402 - 63	IOZ402 - 63	IOZ402 - 63
163.00 - 168.99	OZ402 - 63	IOZ402 - 63	IOZ402 - 63	IOZ402 - 63	IOZ402 - 63

SPARE PARTS

Tool diameter DCN-DCX (mm)	Guide pad							
	Guide pad		Filler		Protector		Sub guide pad	
	⑥	Qty	⑦	Qty	⑧	Qty	⑨	Qty
107.00 - 117.99	GP18	2	FL18 - M	1	GPT18 - M	2	CUG14 - M	1
118.00 - 135.99	GP18	2	FL18 - M	1	GPT18 - M	2	CUG14 - M	1
136.00 - 144.99	GP18	4	FL18 - M	1	GPT18 - M	4	CUG14 - M	1
145.00 - 150.99	GP18	4	FL18 - M	1	GPT18 - M	4	CUG14 - M	1
151.00 - 156.99	GP18	4	FL18 - M	1	GPT18 - M	4	CUG14 - M	1
157.00 - 162.99	GP18	4	FL18 - M	1	GPT18 - M	4	CUG14 - M	1
163.00 - 168.99	GP18	4	FL18 - M	1	GPT18 - M	4	CUG14 - M	1

See page L101 on handling of filler.

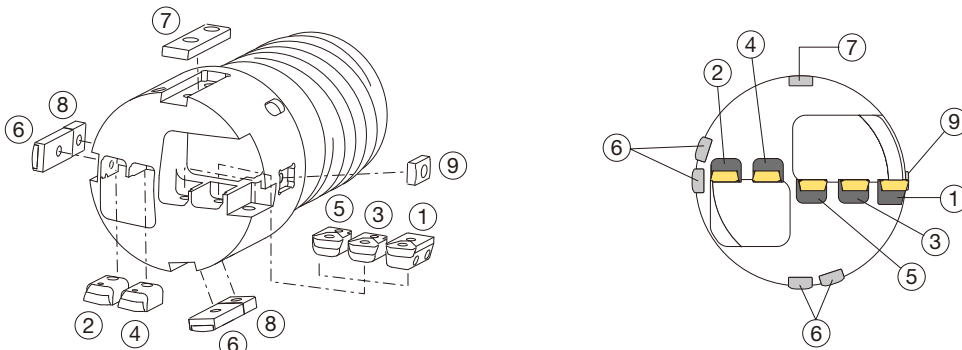

Part positions may vary depending on the drill size.

SCREWS, WRENCHES (CICT = 5)

Tool diameter DCN-DCX (mm)	Insert screw									
	Peripheral		Intermediate				Central			
	Cartridge ①		Cartridge ②		Cartridge ③		Cartridge ④		Cartridge ⑤	
	Screw	Wrench	Screw	Wrench	Screw	Wrench	Screw	Wrench	Screw	Wrench
107.00 - 117.99	CSTB-4M	T-15D	CSTB-3.5D	T-9D	CSTB-3.5D	T-9D	CSTB-3.5D	T-9D	CSTB-4M	T-15D
118.00 - 135.99	CSTB-4M	T-15D	CSTB-4M	T-15D	CSTB-4M	T-15D	CSTB-4M	T-15D	CSTB-4M	T-15D
136.00 - 144.99	CSTB-4M	T-15D	CSTB-4M	T-15D	CSTB-4M	T-15D	CSTB-4M	T-15D	CSTB-5	T-20D
145.00 - 150.99	CSTB-4M	T-15D	CSTB-4M	T-15D	CSTB-5	T-20D	CSTB-4M	T-15D	CSTB-5	T-20D
151.00 - 156.99	CSTB-5	T-20D	CSTB-4M	T-15D	CSTB-5	T-20D	CSTB-4M	T-15D	CSTB-5	T-20D
157.00 - 162.99	CSTB-5	T-20D	CSTB-4M	T-15D	CSTB-5	T-20D	CSTB-5	T-20D	CSTB-5	T-20D
163.00 - 168.99	CSTB-5	T-20D	CSTB-5	T-20D	CSTB-5	T-20D	CSTB-5	T-20D	CSTB-5	T-20D

SCREWS, WRENCHES (CICT = 5)

Tool diameter DCN-DCX (mm)	Cartridge screw								Guide pad screw			
	Peripheral				Intermediate		Central		Guide pad / Filler / Protector		Sub guide pad	
	Cartridge ①		Cartridge ② - ④		Cartridge ⑤							
	Screw	Wrench	Adj. screw	Wrench	Screw	Wrench	Screw	Wrench	Screw	Wrench	Screw	Wrench
107.00 - 117.99	LS1806RH	H4	AS0005-15	H2.5	CSTA-5	T-15D	LS1206	H3	LS1206S	H3	CSTA-5S	T-15D
118.00 - 135.99	LS1806RH	H4	AS0005-15	H2.5	LS1206	H3	LS1206	H3	LS1206SSS	H3	CSTA-5S	T-15D
136.00 - 144.99	LS1806RH	H4	AS0005-15	H2.5	LS1206	H3	LS1206S	H3	LS1206SSS	H3	CSTA-5S	T-15D
145.00 - 150.99	LS1806RH	H4	AS0005-15	H2.5	LS1206	H3	LS1206S	H3	LS1206SSS	H3	CSTA-5S	T-15D
151.00 - 156.99	LS1806RH	H4	AS0006-15	H3	LS1206	H3L	LS1206S	H3L	LS1206S	H3	CSTA-5S	T-15D
157.00 - 162.99	LS1806RH	H4	AS0006-15	H3	LS1206	H3L	LS1206S	H3L	LS1206S	H3	CSTA-5S	T-15D
163.00 - 168.99	LS1806RH	H4	AS0006-15	H3	LS1206	H3L	LS1206S	H3L	LS1206S	H3	CSTA-5S	T-15D

Recommended clamping torque: please see page J148.

Indexable drill head with external 4-start thread for double tube system (DTS), diameters adjustable, tool diameter $\varnothing 169.00 - \varnothing 183.99$ mm, CICT = 7

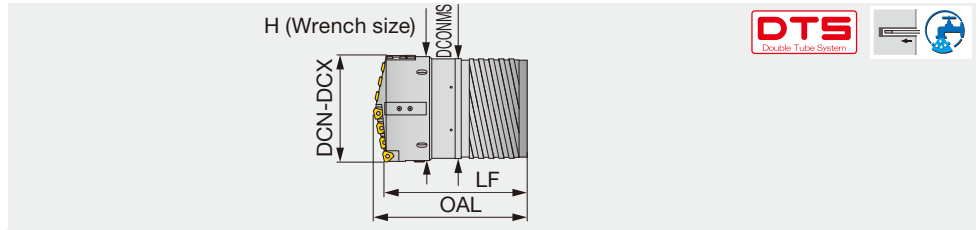

Non-standard products (to be supplied on request)

When ordering

KUDTS**E	- XX.XX
Drill head	Diameter (mm)

e.g. Designation for tool diameter $\varnothing 170$ mm: KUDTS24E-170.00

Designation	DCN	DCX	CICT	Outer tube			Drill head		
				Designation	Dia. (mm)	OAL	LF	DCONMS	H
KUDTS24E-xx.xx	169	171.99	7	OT24	154	246	225	149	167
KUDTS25E-xx.xx	172	183.99	7	OT25	166	247	225	161	179

Before drilling operation, please adjust drill diameter. For diameter adjustment please see page L102.

INSERTS

Tool diameter DCN-DCX (mm)	Peripheral insert	Qty	Intermediate insert	Qty	Central insert	Qty
169.00 - 183.99	TPMX24**R...	1	TPMX24**R...	5	TPMX24**R...	1

⊕ **Plus:** The drill diameter can be increased by up to 5 mm by using the Plus parts. A maximum expandable diameter is determined by the peripheral cartridge size used on the drill. See page J169 for details. Drill heads come with cartridge, guide pad, filler, protector, sub guide pad and wrench, but do not include inserts.

SPARE PARTS

Tool diameter DCN-DCX (mm)	Cartridge						
	Peripheral Cartridge ①	Cartridge ②	Cartridge ③	Cartridge ④	Cartridge ⑤	Cartridge ⑥	Central Cartridge ⑦
169.00 - 183.99	OZ402 - 43	IOZ402 - 43	IOZ402 - 43	IOZ402 - 43	IOZ402 - 43	IOZ402 - 43	IOZ402 - 43

SPARE PARTS

Tool diameter DCN-DCX (mm)	Guide pad							
	Guide pad		Filler		Protector		Sub guide pad	
	⑧	Qty	⑨	Qty	⑩	Qty	⑪	Qty
169.00 - 183.99	GP18	4	FL18 - M	1	GPT18 - M	4	CUG14 - M	1

See page L101 on handling of filler.

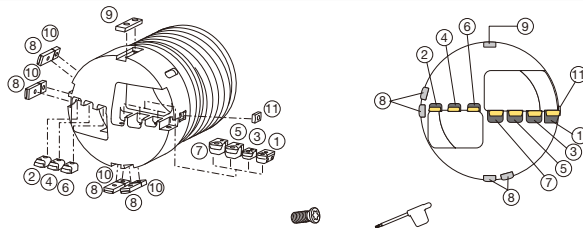

Part positions may vary depending on the drill size.

SCREWS, WRENCHES (CICT = 7)

Tool diameter DCN-DCX (mm)	Insert screw													
	Peripheral Cartridge ①		Cartridge ②		Cartridge ③		Cartridge ④		Cartridge ⑤		Cartridge ⑥		Central Cartridge ⑦	
	Screw	Wrench	Screw	Wrench	Screw	Wrench	Screw	Wrench	Screw	Wrench	Screw	Wrench	Screw	Wrench
169.00 - 183.99	CSTB-4M	T-15D	CSTB-4M	T-15D	CSTB-4M	T-15D	CSTB-4M	T-15D	CSTB-4M	T-15D	CSTB-4M	T-15D	CSTB-4M	T-15D

SCREWS, WRENCHES (CICT = 7)

Tool diameter DCN-DCX (mm)	Cartridge screw						Guide pad screw					
	Peripheral Cartridge ①		Intermediate Cartridge ② - ⑥		Central Cartridge ⑦		Guide pad / Filler / Protector			Sub guide pad		
	Screw	Wrench	Adj. screw	Wrench	Screw	Wrench	Screw	Wrench	Screw	Wrench	Screw	Wrench
169.00 - 183.99	LS1806RH	H4	AS0005-15	H2.5	LS1206	H3L	LS1206	H3L	LS1206SSS	H3	CSTA-5S	T-15D

Recommended clamping torque: please see page J148.

STANDARD CUTTING CONDITIONS

See more information

e-catalog



Reference pages: Inserts → J146, Guide pads → J147, Drill tube (DTS) → J160

INSERT

NPMX**R, TPMX**R

NPMX type

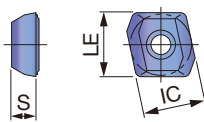

TPMX type

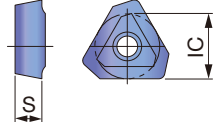

P Steel	★	★	☆	☆					
M Stainless	☆	★	☆	☆					
K Cast iron	☆	★	☆	☆					
N Non-ferrous	☆	★	☆	☆					
S Superalloys	☆	☆	★	☆					
H Hard materials	☆	☆	★	☆					

★ : First choice
☆ : Second choice

Designation	HAND	Coated				IC	S	RE	LE
		T9225	AH9130	AH8015	UC2220				
NPMX080308R-G	R	●	●			8	3.18	-	8.362
NPMX080304R-B	R				●	8	3.18	-	8.362
TPMX140308R-G	R	●	●	●	●	8.45	3.5	0.8	-
TPMX140304R-B	R				●	8.45	3.5	0.4	-
TPMX140308R-B	R		●	●		8.45	3.5	0.8	-
TPMX140308R-DT	R		●		●	8.45	3.5	0.8	-
TPMX170408R-G	R	●	●	●	●	10.3	4	0.8	-
TPMX170404R-B	R				●	10.3	4	0.4	-
TPMX170408R-B	R		●	●		10.3	4	0.8	-
TPMX170408R-BG	R		●	●	●	10.3	4	0.8	-
TPMX170408R-DT	R		●		●	10.3	4	0.8	-
TPMX240512R-G	R	●	●	●	●	14.2	5.5	1.2	-
TPMX240504R-B	R				●	14.2	5.5	0.4	-
TPMX240512R-B	R		●	●		14.2	5.5	1.2	-
TPMX240512R-BG	R		●	●	●	14.2	5.5	1.2	-
TPMX240512R-DT	R		●		●	14.2	5.5	1.2	-
TPMX280716R-G	R	●	●	●	●	17	7.5	1.6	-
TPMX280708R-B	R				●	17	7.5	0.8	-
TPMX280716R-B	R		●	●		17	7.5	1.6	-
TPMX280716R-BG	R		●	●	●	17	7.5	1.6	-
TPMX280716R-DT	R		●		●	17	7.5	1.6	-

● : Line up
Package quantity = 10 pcs.

Chipbreaker

<p>G</p> <p>Versatile</p>	<p>B</p> <p>Provides good chip control in heat-resistant alloys</p>
<p>BG</p> <p>Provides good chip control in long-chipping steels</p>	<p>DT</p> <p>Reduced cutting force</p>

Insert grade

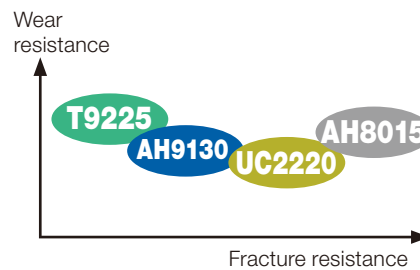

GUIDE PAD

GP08, 10, 14, 18

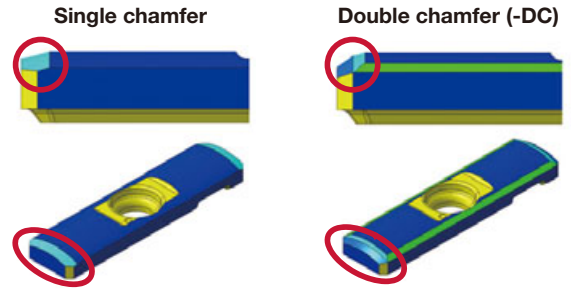
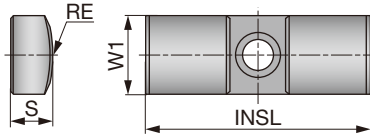

Designation	DCN	DCX	Coated			W1	INSL	S	RE	Chamfer
			F1122	FH3125	FH3135					
GP08	38	44.99	●			8	25	4.5	15.5	Single
GP08-25-155-DC	38	44.99		●	●	8	25	4.5	15.5	Double
GP10	45	59.99	●			10	35	6	20	Single
GP10-35-200-DC	45	59.99		●	●	10	35	6	20	Double
GP14-40-250-DC	60	98.99		●	●	14	40	7.5	25	Double
GP18-40-300-DC	99	293.99		●	●	18	40	9	30	Double

●: Line up
Package quantity = 5 pcs.

Grade recommendations

ISO	Oil coolant			Water based coolant	
	First choice	Second choice	Third choice	First choice	Second choice
P	FH3125	F1122	FH3135	FH3135	FH3125
M	FH3135	FH3125	F1122	FH3135	FH3125
K	FH3125	F1122	FH3135	FH3135	FH3125
N	FH3125	F1122	FH3135	FH3135	FH3125
S	FH3135	FH3125	F1122	FH3135	FH3125
H	FH3135	FH3125	F1122	FH3135	FH3125

Grade
Insert
Int. Toolholder
Ext. Toolholder
Threading
Grooving
Miniature tool
Milling cutter
Endmill
Drilling tool
Tooling System
User's Guide
Index



Replacement parts

Cartridges and inserts

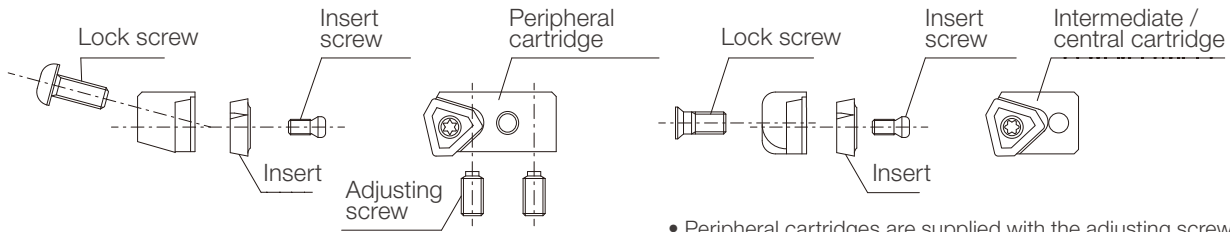

- Peripheral cartridges are supplied with the adjusting screws and insert screw (inserts, lock screw and wrenches are not included)
- Central and intermediate cartridges are supplied with insert screw (inserts, lock screw and wrenches are not included)

Peripheral inserts and accessories

Cartridge	Insert	Insert screw	Wrench	Adjusting screw	Wrench	Lock screw	Wrench
OZ05R	NPMX080308R-G	CSTB-2.2	T-7D	AS0003-5	H1.5	LS1803RH	H2
OZ402-04	TPMX140308R-G	CSTB-2.5	T-8D	AS0004-8	H2	LS1803.5RH	H2.5
OZ402-32	TPMX170408R-G	CSTB-3.5D	T-9D	AS0005-10	H2.5	LS1805RH	H3
OZ402-43	TPMX240512R-G	CSTB-4M	T-15D	AS0005-15	H2.5	LS1806RH	H4
OZ402-63	TPMX280716R-G	CSTB-5	T-20D	AS0006-15	H3	LS1806RH	H4

Central and intermediate inserts and accessories

Cartridge	Insert	Insert screw	Wrench	Lock screw	Wrench
IOZ05R	NPMX080308R-G	CSTB-2.2	T-7D	CSTB-3	T-9D
IOZ402-04	TPMX140308R-G	CSTB-2.5	T-8D	CSTB-3.5	T-15D
IOZ402-32	TPMX170408R-G	CSTB-3.5D	T-9D	CSTA-5	T-15D
IOZ402-43	TPMX240512R-G	CSTB-4M	T-15D	LS1206	H3 / H3L**
IOZ402-63	TPMX280716R-G	CSTB-5	T-20D	LS1206 / LS1206S*	H3 / H3L**

*LS1206S for central cartridge

**H3L for $\phi 151.00$ mm - $\phi 320.00$ mm

Guide pads and protectors

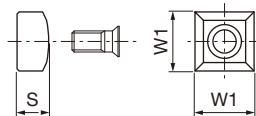

Guide pad	Lock screw	Wrench	Protector	Dimensions (mm)		Lock screw	Wrench
				W1	S		
GP08	CSTB-3S	T-9D	GPT08	8	4.5	CSTB-3S	T-9D
GP08-25-155-DC	CSTB-3S	T-9D	GPT08	8	4.5	CSTB-3S	T-9D
GP10	CSTB-4S	T-15D	GPT10	10	6	CSTB-4S	T-15D
GP10-35-200-DC	CSTB-4S	T-15D	GPT10	10	6	CSTB-4S	T-15D
GP14	CSTA-5S	T-15D	GPT14	14	7.5	CSTA-5S	T-15D
GP14-40-250-DC	CSTA-5S	T-15D	GPT14	14	7.5	CSTA-5S	T-15D
GP18	LS1206S / LS1206SSS ***	H3	GPT18-M	18	9	LS1206S	H3
GP18-40-300-DC	LS1206S / LS1206SSS ***	H3	GPT18-M	18	9	LS1206S	H3

***LS1206SSS for dimensional guide pad

(for diameter $\phi 118.00$ - $\phi 150.99$, $\phi 169.00$ - $\phi 208.99$ and $\phi 233.00$ - $\phi 247.99$ mm)

Recommended clamping torque

Screw	(N·m)	Screw	(N·m)	Screw	(N·m)
CSTA-5	3.5	CSTB-3.5	3.5	LS1206S	3
CSTA-5S	3.5	CSTB-3.5D	2.3	LS1206SSS	3
CSTB-2.2	1	CSTB-4M	3.5	LS1803RH	2.2
CSTB-2.5	1.3	CSTB-4S	3.5	LS1803.5RH	2.2
CSTB-3	2.3	CSTB-5	5	LS1805RH	3
CSTB-3S	2.3	LS1206	3	LS1806RH	5

Sub guide pad

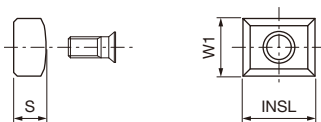

Guide pad	Dimensions (mm)			Lock screw	Wrench
	W1	S	INSL		
CUG08	8	4.5	10	CSTB-3S	T-9D
CUG10	10	5	10	CSTB-3S	T-9D
CUG14-M	14	7	20	CSTA-5S	T-15D

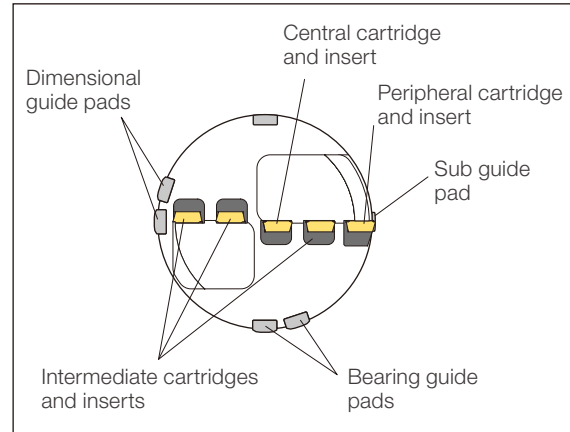

Plus Plus parts

The use of the Plus parts allows the drill diameter to increase by up to 5 mm, in 1 mm increments. The diameter is increased by replacing the peripheral cartridges.

Ex. The drill head diameter with OZ402-32 peripheral cartridge can be increased by up to 4 mm, while the drill head diameter with OZ402-43 can be increased by up to 5 mm.

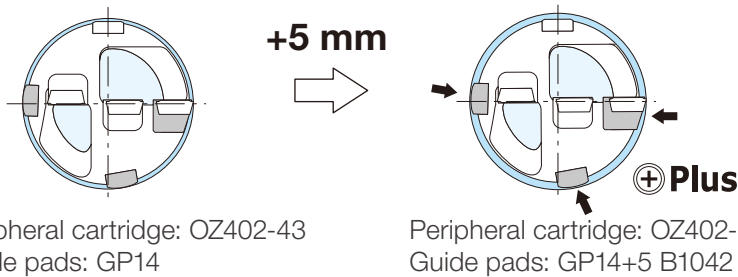

Note:
When the peripheral cartridge is changed, the guide pads must also be changed to the matching Plus parts.

Plus cartridge - OZ type

	+1 mm	+2 mm	+3 mm	+4 mm	+5 mm
OZ05R	OZ05R+1 ○	OZ05R+2 ○	-	-	-
OZ402-04	OZ402-04+1 ○	OZ402-04+2 ○	OZ402-04+3 ○	-	-
OZ402-32	OZ402-32+1 ○	OZ402-32+2 ○	OZ402-32+3 ○	OZ402-32+4 ○	-
OZ402-43	OZ402-43+1 ○	OZ402-43+2 ○	OZ402-43+3 ○	OZ402-43+4 ○	OZ402-43+5 ○
OZ402-63	OZ402-63+1 ○	OZ402-63+2 ○	OZ402-63+3 ○	OZ402-63+4 ○	OZ402-63+5 ○

Ordering example: OZ402-04+2, 1 pcs

Plus cartridge - OX type

	+1 mm	+2 mm	+3 mm	+4 mm	+5 mm
OX04R	OX04R+1 ○	OX04R+2 ○	OX04R+3 ○	-	-
OX32R	OX32R+1 ○	OX32R+2 ○	OX32R+3 ○	OX32R+4 ○	-
OX43R	OX43R+1 ○	OX43R+2 ○	OX43R+3 ○	OX43R+4 ○	OX43R+5 ○
OX63R	OX63R+1 ○	OX63R+2 ○	OX63R+3 ○	OX63R+4 ○	OX63R+5 ○

Ordering example: OX32R+2, 1 pcs

Use OX cartridges when using the UNIDEX series for boring operations. OX has a smaller entry angel than OZ, allowing better hole quality.

OX and OZ can be mounted in the same pocket for the peripheral cartridge.

Plus guide pad

	+1 mm	Grade B1042	+2 mm	Grade B1042	+3 mm	Grade B1042	+4 mm	Grade B1042	+5 mm	Grade B1042
GP08	GP08+1 ○	○	GP08+2 ○	○	GP08+3 ○	○	-	-	-	-
GP10	GP10+1 ○	○	GP10+2 ○	○	GP10+3 ○	○	GP10+4 ○	○	-	-
GP14	GP14+1 ○	○	GP14+2 ○	○	GP14+3 ○	○	GP14+4 ○	○	GP14+5 ○	○
GP18	GP18+1 ○	○	GP18+2 ○	○	GP18+3 ○	○	GP18+4 ○	○	GP18+5 ○	○

Ordering example: GP08+2 B1042, 5 pcs

○ : To be supplied on request

MBU STS

MBU type drill head

Brazed drill head with external single-start thread for single tube system (STS),
tool diameter $\varnothing 8 - \varnothing 14.79$ mm, CICT = 1

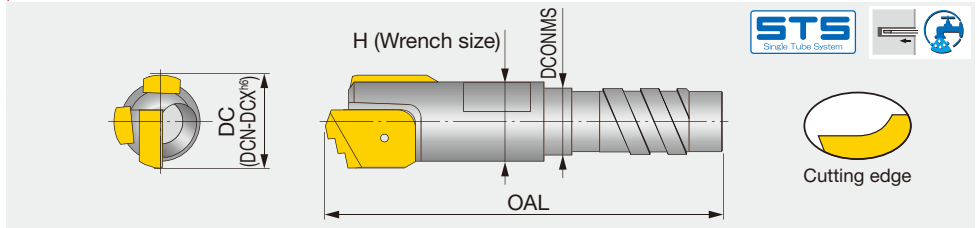

2-effective Drill
 4-effective Drill
 Indexable Drill
 Deep Hole Drill
 Reamer

P	Steel	★	
M	Stainless	★	
K	Cast iron	★	
N	Non-ferrous	★	
S	Superalloys	★	
H	Hard materials	★	

★ : First choice
☆ : Second choice

Standard products

Designation	Coated		Drill tube				
	DC		Designation	Dia. (mm)	OAL	DCONMS	H
MBU-0999-2 9.40	9.4	●	UMBB083	8.3	34	7.2	7
MBU-1199-1 11.00	11	●	UMBB100	10	34	8.6	9

● : Line up

Non-standard products (to be supplied on request)

When ordering

MBU-0899-1	xx.xx	1122
Drill head	Diameter (mm)	Grade

e.g. Designation for tool diameter $\varnothing 9$ mm: MBU-0899-1 9.00 1122

Designation	Coated		Drill tube				
	DCN	DCX	Designation	Dia. (mm)	OAL	DCONMS	H
MBU-0899-1 xx.xx	8	8.32	UMBB071	7.1	34	6	6
MBU-0899-2 xx.xx	8.33	8.65	UMBB071	7.1	34	6	6
MBU-0899-3 xx.xx	8.66	8.99	UMBB071	7.1	34	6	6
MBU-0999-1 xx.xx	9	9.32	UMBB083	8.3	34	7.2	7
MBU-0999-2 xx.xx	9.33	9.65	UMBB083	8.3	34	7.2	7
MBU-0999-3 xx.xx	9.66	9.99	UMBB083	8.3	34	7.2	7
MBU-1099-1 xx.xx	10	10.32	UMBB090	9	34	7.6	8
MBU-1099-2 xx.xx	10.33	10.65	UMBB090	9	34	7.6	8
MBU-1099-3 xx.xx	10.66	10.99	UMBB090	9	34	7.6	8
MBU-1199-1 xx.xx	11	11.32	UMBB100	10	34	8.6	9
MBU-1199-2 xx.xx	11.33	11.65	UMBB100	10	34	8.6	9
MBU-1199-3 xx.xx	11.66	11.99	UMBB100	10	34	8.6	9
MBU-1349-1 xx.xx	12	12.36	UMBB110	11	34	9.1	10
MBU-1349-2 xx.xx	12.37	12.73	UMBB110	11	34	9.1	10
MBU-1349-3 xx.xx	12.74	13.1	UMBB110	11	34	9.1	10
MBU-1349-4 xx.xx	13.11	13.49	UMBB110	11	34	9.1	10
MBU-1449-1 xx.xx	13.5	13.82	UMBB120	12	34	10.8	11
MBU-1449-2 xx.xx	13.83	14.15	UMBB120	12	34	10.8	11
MBU-1449-3 xx.xx	14.16	14.48	UMBB120	12	34	10.8	11
MBU-1449-4 xx.xx	14.49	14.79	UMBB120	12	34	10.8	11

STANDARD CUTTING CONDITIONS

See more information

e-catalog



Reference pages: Drill tube (STS) → **J156**

UTE STS

MBU type drill head

Brazed drill head with external 2-start or 4-start thread for single tube system (STS), tool diameter $\phi 12.6 - \phi 20$ mm, CICT = 1

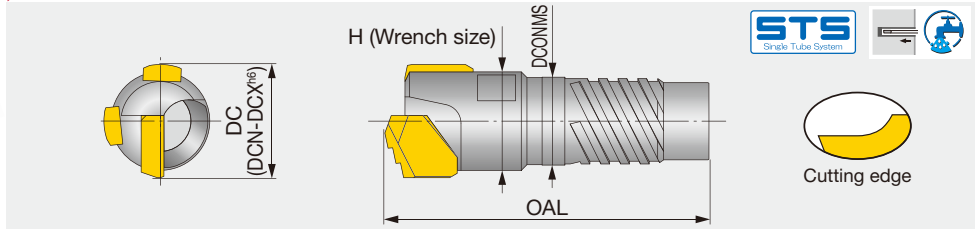

P	Steel	★
M	Stainless	
K	Cast iron	
N	Non-ferrous	
S	Superalloys	
H	Hard materials	

★ : First choice
☆ : Second choice

Standard products

Designation	DC	1122	Coated	Drill tube				
				Designation	Dia. (mm)	OAL	DCONMS	H
UTE-0094-1 12.90	12.9	●		ST0094	11	40	9.6	10

● : Line up

Non-standard products (to be supplied on request)

When ordering

UTE-0094-1	XX.XX	1122
Drill head	Diameter (mm)	Grade

e.g. Designation for tool diameter $\phi 12.92$ mm: UTE-0094-1 12.92 1122

Designation	DCN	DCX	Drill tube		OAL	DCONMS	H
			Designation	Dia. (mm)			
UTE-0094-1 xx.xx	12.6	12.92	ST0094	11	40	9.6	10
UTE-0094-2 xx.xx	12.93	12.99	ST0094	11	40	9.6	10
UTE-0094-3 xx.xx	13	13.25	ST0094	11	40	9.6	10
UTE-0094-4 xx.xx	13.26	13.6	ST0094	11	40	9.6	10
UTE-0095-1 xx.xx	13.61	13.93	ST0095	12	40	10.6	11
UTE-0095-2 xx.xx	13.94	13.99	ST0095	12	40	10.6	11
UTE-0095-3 xx.xx	14	14.26	ST0095	12	40	10.6	11
UTE-0095-4 xx.xx	14.27	14.6	ST0095	12	40	10.6	11
UTE-0096-1 xx.xx	14.61	14.93	ST0096	13	40	11.6	12
UTE-0096-2 xx.xx	14.94	15.26	ST0096	13	40	11.6	12
UTE-0096-3 xx.xx	15.27	15.59	ST0096	13	40	11.6	12
UTE-0097-1 xx.xx	15.6	15.96	ST0097	14	40	12.6	13
UTE-0097-2 xx.xx	15.97	16.32	ST0097	14	40	12.6	13
UTE-0097-3 xx.xx	16.33	16.7	ST0097	14	40	12.6	13
UTE-0098-1 xx.xx	16.71	17.03	ST0098	15	40	13.6	14
UTE-0098-2 xx.xx	17.04	17.36	ST0098	15	40	13.6	14
UTE-0098-3 xx.xx	17.37	17.7	ST0098	15	40	13.6	14
UTE-0099-1 xx.xx	17.71	18.09	ST0099	16	40	14.5	15
UTE-0099-2 xx.xx	18.1	18.48	ST0099	16	40	14.5	15
UTE-0099-3 xx.xx	18.49	18.9	ST0099	16	40	14.5	15
UTE-0000-1 xx.xx	18.91	19.26	ST0000	17	40	15.5	16
UTE-0000-2 xx.xx	19.27	19.62	ST0099	17	40	15.5	16
UTE-0000-3 xx.xx	19.63	20	ST0099	17	40	15.5	16

UTE Drill head : $\phi 12.6$ mm - $\phi 15.59$ mm, External 2-start thread
UTE Drill head : $\phi 15.6$ mm - $\phi 20$ mm, External 4-start thread

STANDARD CUTTING CONDITIONS

See more information

e-catalog



Reference pages: Drill tube (STS) → **J156**



BTU STS

BTU type drill head (Small diameter, 2 edges)

Brazed drill head with external 2-start thread for single tube system (STS),
tool diameter $\varnothing 12.6 - \varnothing 15.59$ mm, CICT = 2

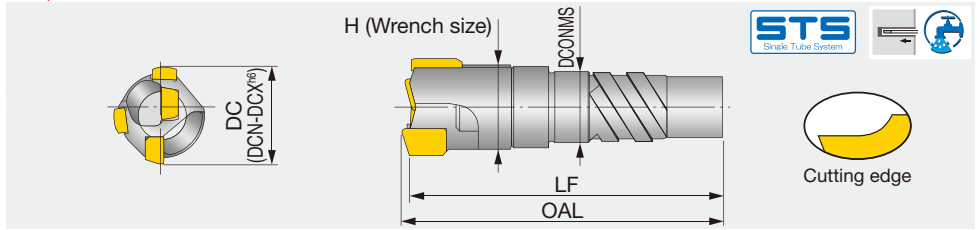

Non-standard products (to be supplied on request)

When ordering

BTU-00941

Drill head

XX.XX

Diameter (mm)

1122

Grade

e.g. Designation for tool diameter $\varnothing 13.1$ mm: **BTU-00941 13.10 1122**

Designation	DCN	DCX	Drill tube		OAL	LF	DCONMS	H
			Designation	Dia. (mm)				
BTU-00941 xx.xx	12.6	13.1	ST0094	11	43	41.9	9.6	10
BTU-00942 xx.xx	13.11	13.6	ST0094	11	43	41.9	9.6	10
BTU-00951 xx.xx	13.61	14.1	ST0095	12	43	41.8	10.6	11
BTU-00952 xx.xx	14.11	14.6	ST0095	12	43	41.8	10.6	11
BTU-00961 xx.xx	14.61	15.1	ST0096	13	43	41.7	11.6	12
BTU-00962 xx.xx	15.11	15.59	ST0096	13	43	41.7	11.6	12

STANDARD CUTTING CONDITIONS

See more information

e-catalog



Reference pages: Drill tube (STS) → **J156**

BTU type drill head (2 edges)

Brazed drill head with external 4-start thread for single tube system (STS),
tool diameter $\varnothing 15.6 - \varnothing 65$ mm, CICT = 3

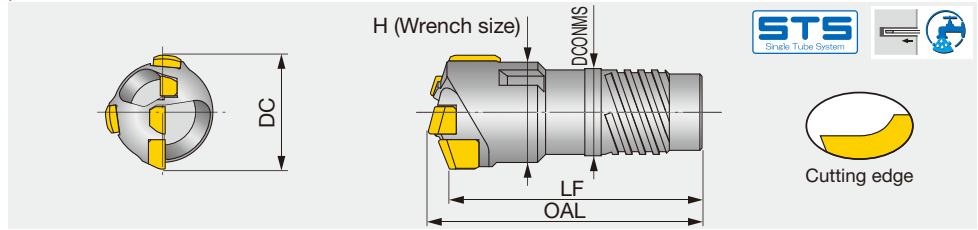

Standard products

P	Steel	★			
M	Stainless	★	★		
K	Cast iron			★	
N	Non-ferrous				★
S	Superalloys				
H	Hard materials			★	

★ : First choice
☆ : Second choice

Designation	DC	Coated			Drill tube					
		1132	2122	3132	Designation	Dia. (mm)	OAL	LF	DCONMS	H
BTU-00971 16.11	16.11	●			ST0097	14	43	40.3	12.6	-
BTU-00971 16.13	16.13	●			ST0097	14	43	40.3	12.6	-
BTU-002 19.26	19.26		●		ST0000	17	47	44	15.5	18
BTU-002 19.27	19.27	●			ST0000	17	47	44	15.5	18
BTU-002 19.28	19.28	●			ST0000	17	47	44	15.5	18
BTU-002 19.3	19.3	●			ST0000	17	47	44	15.5	18
BTU-011 20.21	20.21	●			ST00	18	52.5	49.4	16	18
BTU-011 20.28	20.28	●			ST00	18	52.5	49.4	16	18
BTU-021 22.1	22.1			●	ST01	20	56	52.8	18	20
BTU-022 23.6	23.6			●	ST01	20	56	52.6	18	21
BTU-032 25.26	25.26	●			ST02	22	57.5	54	19.5	24
BTU-032 25.28	25.28	●			ST02	22	57.5	54	19.5	24
BTU-032 25.66	25.66	●			ST02	22	57.5	54	19.5	24
BTU-032 25.67	25.67	●			ST02	22	57.5	54	19.5	24
BTU-032 25.68	25.68	●			ST02	22	57.5	54	19.5	24
BTU-032 26.4	26.4		●		ST02	22	57.5	54	19.5	24

● : Line up

STANDARD CUTTING CONDITIONS

See more information

e-catalog



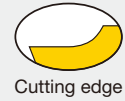
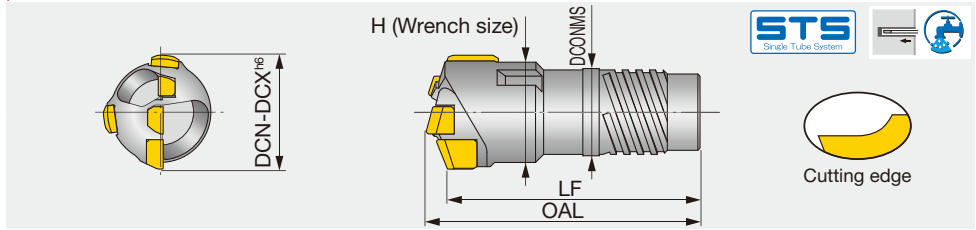

Non-standard products (to be supplied on request)

When ordering

BTU-00971	xx.xx	1122
Drill head	Diameter (mm)	Grade

e.g. Designation for tool diameter $\varnothing 16.2$ mm: **BTU-00971 16.20 1122**

Designation	DCN	DCX	Drill tube		OAL	LF	DCONMS	H
			Designation	Dia. (mm)				
BTU-00971 xx.xx	15.6	16.2	ST0097	14	43	40.3	12.6	-
BTU-00972 xx.xx	16.21	16.7	ST0097	14	43	40.3	12.6	14
BTU-00981 xx.xx	16.71	17.2	ST0098	15	43	40.3	13.6	15
BTU-00982 xx.xx	17.21	17.7	ST0098	15	43	40.3	13.6	15
BTU-00991 xx.xx	17.71	18.4	ST0099	16	47	44.2	14.5	15
BTU-00992 xx.xx	18.41	18.9	ST0099	16	47	44.1	14.5	-
BTU-001 xx.xx	18.91	19.2	ST0000	17	47	44.1	15.5	17
BTU-002 xx.xx	19.21	20	ST0000	17	47	44	15.5	18
BTU-011 xx.xx	20.01	20.9	ST00	18	52.5	49.4	16	18
BTU-012 xx.xx	20.91	21.8	ST00	18	52.5	49.4	16	19
BTU-021 xx.xx	21.81	22.9	ST01	20	56	52.8	18	20
BTU-022 xx.xx	22.91	24.1	ST01	20	56	52.6	18	21
BTU-031 xx.xx	24.11	25.2	ST02	22	57.5	54	19.5	23
BTU-032 xx.xx	25.21	26.4	ST02	22	57.5	54	19.5	24
BTU-041 xx.xx	26.41	27.5	ST03	24	57.5	53.8	21	25
BTU-042 xx.xx	27.51	28.7	ST03	24	57.5	53.8	21	26
BTU-051 xx.xx	28.71	29.8	ST04	26	63.5	59.5	23.5	27
BTU-052 xx.xx	29.81	31	ST04	26	63.5	59.3	23.5	28
BTU-061 xx.xx	31.01	32.1	ST05	28	63.5	59.4	25.5	29
BTU-062 xx.xx	32.11	33.3	ST05	28	63.5	59.1	25.5	30
BTU-071 xx.xx	33.31	34.8	ST06	30	63.5	59	28	32
BTU-072 xx.xx	34.81	36.2	ST06	30	63.5	58.9	28	33
BTU-081 xx.xx	36.21	37.3	ST07	33	73.5	68.7	30	34
BTU-082 xx.xx	37.31	38.4	ST07	33	73.5	68.5	30	35
BTU-083 xx.xx	38.41	39.6	ST07	33	73.5	68.3	30	36
BTU-091 xx.xx	39.61	40.6	ST08	36	73.5	68.2	33	37
BTU-092 xx.xx	40.61	41.8	ST08	36	73.5	68	33	38
BTU-093 xx.xx	41.81	43	ST08	36	73.5	67.8	33	39
BTU-101 xx.xx	43.01	44.3	ST09	39	75	69.5	36	41
BTU-102 xx.xx	44.31	45.6	ST09	39	75	69.3	36	42
BTU-103 xx.xx	45.61	47	ST09	39	75	69.1	36	43
BTU-111 xx.xx	47.01	48.5	ST10	43	75	68.8	39	44
BTU-112 xx.xx	48.51	50.1	ST10	43	75	68.7	39	46
BTU-113 xx.xx	50.11	51.7	ST10	43	75	68.5	39	47
BTU-121 xx.xx	51.71	53.2	ST11	47	82	75.2	43	49
BTU-122 xx.xx	53.21	54.7	ST11	47	82	75.2	43	50
BTU-123 xx.xx	54.71	56.2	ST11	47	82	75.2	43	51
BTU-131 xx.xx	56.21	58.4	ST12	51	84	77.4	47	54
BTU-132 xx.xx	58.41	60.6	ST12	51	84	76.9	47	55
BTU-133 xx.xx	60.61	62.8	ST12	51	84	76.8	47	57
BTU-134 xx.xx	62.81	65	ST12	51	84	76.5	47	59
BTU-133L xx.xx	60.61	62.8	ST13	56	84	76.8	51	57
BTU-134L xx.xx	62.81	65	ST13	56	84	76.5	51	59

STANDARD CUTTING CONDITIONS

See more information

e-catalog



Reference pages: Drill tube (STS) → **J156**

ETU DTS

ETU type drill head

Brazed drill head with external 4-start thread for double tube system (DTS), tool diameter $\varnothing 18.4 - \varnothing 65$ mm, CICT = 3

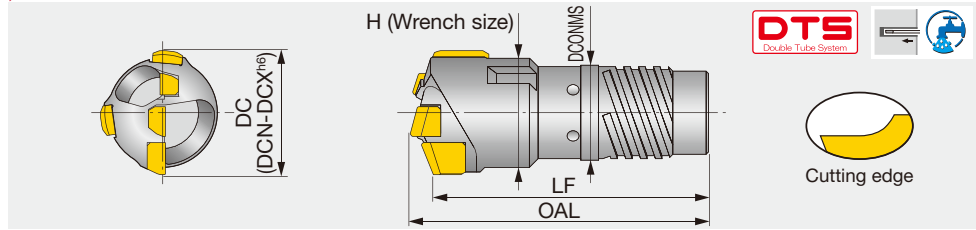

Non-standard products (to be supplied on request)

When ordering

ETU-001	XX.XX	1122
Drill head	Diameter (mm)	Grade

e.g. Designation for tool diameter $\varnothing 19.2$ mm: **ETU-001 19.20 1122**

Designation	DCN	DCX	Drill tube		OAL	LF	DCONMS	H
			Designation	Dia. (mm)				
ETU-001 xx.xx	18.4	19.2	OT00	18	50	47.1	16	17
ETU-002 xx.xx	19.21	20	OT00	18	50	47	16	18
ETU-011 xx.xx	20.01	20.9	OT01	20	56	52.8	18	18
ETU-012 xx.xx	20.91	21.8	OT01	20	56	52.7	18	19
ETU-021 xx.xx	21.81	22.9	OT02	22	56	52.8	19.5	20
ETU-022 xx.xx	22.91	24.1	OT02	22	56	52.6	19.5	21
ETU-031 xx.xx	24.11	25.2	OT03	24	57.5	54	21	23
ETU-032 xx.xx	25.21	26.4	OT03	24	57.5	54	21	24
ETU-041 xx.xx	26.41	27.5	OT04	26	60.5	56.8	23.5	25
ETU-042 xx.xx	27.51	28.7	OT04	26	60.5	56.8	23.5	26
ETU-051 xx.xx	28.71	29.8	OT05	28	63.5	59.5	25.5	27
ETU-052 xx.xx	29.81	31	OT05	28	63.5	59.3	25.5	28
ETU-061 xx.xx	31.01	32.1	OT06	31	63.5	59.4	28	29
ETU-062 xx.xx	32.11	33.3	OT06	31	63.5	59.2	28	30
ETU-071 xx.xx	33.31	34.8	OT07	33	70.5	66	30	32
ETU-072 xx.xx	34.81	36.2	OT07	33	70.5	65.8	30	33
ETU-081 xx.xx	36.21	37.3	OT08	36	73.5	68.7	33	34
ETU-082 xx.xx	37.31	38.4	OT08	36	73.5	68.5	33	35
ETU-083 xx.xx	38.41	39.6	OT08	36	73.5	68.3	33	36
ETU-091 xx.xx	39.61	40.6	OT09	39	73.5	68.2	36	37
ETU-092 xx.xx	40.61	41.8	OT09	39	73.5	68	36	38
ETU-093 xx.xx	41.81	43	OT09	39	73.5	67.9	36	39
ETU-101 xx.xx	43.01	44.3	OT10	43	75	69.5	39	41
ETU-102 xx.xx	44.31	45.6	OT10	43	75	69.3	39	42
ETU-103 xx.xx	45.61	47	OT10	43	75	69.1	39	43
ETU-111 xx.xx	47.01	48.5	OT11	47	79	72.9	43	44
ETU-112 xx.xx	48.51	50.1	OT11	47	79	72.8	43	46
ETU-113 xx.xx	50.11	51.7	OT11	47	79	72.5	43	47
ETU-121 xx.xx	51.71	53.2	OT12	51	82	75.3	47	49
ETU-122 xx.xx	53.21	54.7	OT12	51	82	75.5	47	50
ETU-123 xx.xx	54.71	56.2	OT12	51	82	75.3	47	51
ETU-131 xx.xx	56.21	58.4	OT13	56	84	77.4	51	54
ETU-132 xx.xx	58.41	60.6	OT13	56	84	76.9	51	55
ETU-133 xx.xx	60.61	62.8	OT13	56	84	77	51	57
ETU-134 xx.xx	62.81	65	OT13	56	84	76.6	51	59

STANDARD CUTTING CONDITIONS

See more information

e-catalog



Reference pages: Drill tube (DTS) → **J160**



ST STS

ST - for single tube system

Drill tube for single tube system (STS), internal thread type, 2-start thread (tool dia. $\leq \varnothing 15.59$ mm) or 4-start thread (tool dia. $\geq \varnothing 15.6$ mm)

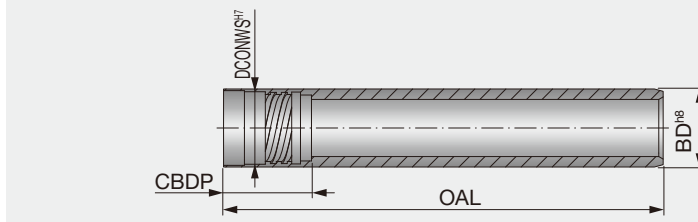

Designation	DCN-DCX	1600	OAL 2600	Special length	BD	DCONWS	CBDP	Designation	DCN-DCX	OAL Special length	BD	DCONWS	CBDP
ST0094	12.6 - 13.6	●	○	11	9.6	22	ST14	65 - 66.99	○	56	52	75	
ST0095	13.61 - 14.6	●	○	12	10.6	22	ST15	67 - 72.99	○	62	58	75	
ST0096	14.61 - 15.59	●	○	13	11.6	22	ST16	73 - 79.99	○	68	63	75	
ST0097	15.6 - 16.7	●	○	14	12.6	21	ST17	80 - 86.99	○	75	70	97	
ST0098	16.71 - 17.7	●	○	15	13.6	21	ST18	87 - 99.99	○	82	77	97	
ST0099	17.71 - 18.9	●	○	16	14.5	22	ST19	100 - 111.99	○	94	89	97	
ST0000	18.91 - 20	●	○	17	15.5	22	ST20	112 - 123.99	○	106	101	118	
ST00	20.01 - 21.8	●	○	18	16	27.5	ST21	124 - 135.99	○	118	113	118	
ST01	21.81 - 24.1	●	○	20	18	30	ST22	136 - 147.99	○	130	125	118	
ST02	24.11 - 26.4	●	○	22	19.5	30	ST23	148 - 159.99	○	142	137	139	
ST03	26.41 - 28.7	●	○	24	21	30	ST24	160 - 171.99	○	154	149	139	
ST04	28.71 - 31	●	○	26	23.5	33	ST25	172 - 183.99	○	166	161	139	
ST05	31.01 - 33.3	●	○	28	25.5	33	ST26	184 - 195.99	○	178	173	144	
ST06	33.31 - 36.2	●	○	30	28	33	ST27	196 - 207.99	○	190	185	144	
ST07	36.21 - 39.6	●	○	33	30	40	ST28	208 - 219.99	○	202	197	144	
ST08	39.61 - 43	●	○	36	33	40	ST29	220 - 231.99	○	214	208	164	
ST09	43.01 - 47	●	○	39	36	40	ST30	232 - 243.99	○	226	220	164	
ST10	47.01 - 51.7	●	○	43	39	40	ST31	244 - 255.99	○	238	232	164	
ST11	51.71 - 56.2	●	○	47	43	44	ST32	256 - 267.99	○	250	244	184	
ST12	56.21 - 60.6	●	○	51	47	44	ST33	268 - 279.99	○	262	256	184	
ST13	60.61 - 65	●	○	56	51	44	ST34	280 - 291.99	○	274	268	184	

Please specify the length (OAL) when ordering.
e.g. For $\varnothing 60$ mm drill diameter / 2600 mm drill tube length: ST12X2600
The lengths that are not in the above will be available upon request.

● : Line up
○ : Item to be customized

UMBB STS

UMBB - for single tube system with MBU

Drill tube with internal single-start thread for MBU drill head

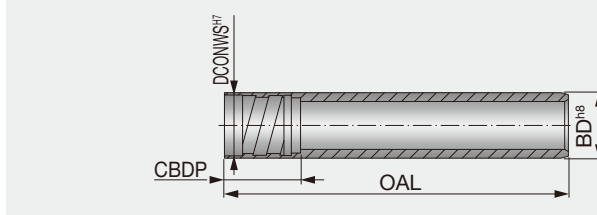

Designation	DCN-DCX	OAL Special length	BD	DCONWS	CBDP
UMBB071	8 - 8.99	○	7.1	6	13.5
UMBB083	9 - 9.99	○	8.3	7.2	13.5
UMBB090	10 - 10.99	○	9	7.6	13.5
UMBB100	11 - 11.99	○	10	8.6	13.5
UMBB110	12 - 13.49	○	11	9.1	13.5
UMBB120	13.5 - 14.79	○	12	10.8	13.5

Please specify the length (OAL) when ordering.
e.g. For $\varnothing 11$ mm drill diameter / 1000 mm drill tube length: UMBB100X1000

○ : Item to be customized

Reference pages: ST: Drill head → **J116** (TRI-FINE STS-EX), **J121** (FINE-BEAM STS-EX), **J129** (UNIDEX STS-EX),
J151 (UTE), **J152 - J154** (BTU)
UMBB: Drill head → **J150** (MBU)

■ Tube length for special drills

Drill tubes with non-standard lengths will be available upon request. Please use the guide below to calculate the drill tube length.

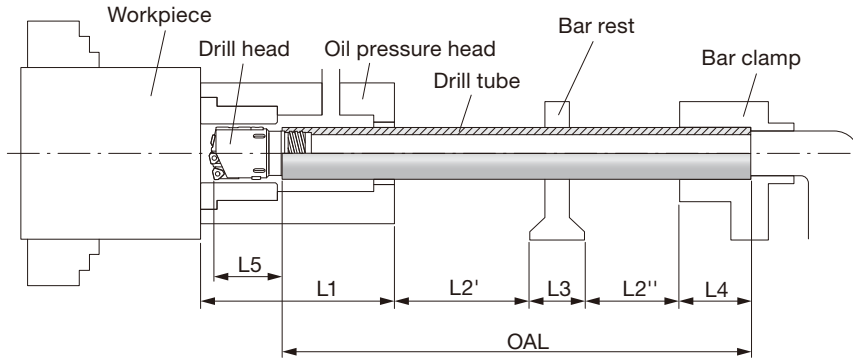

OAL = Drill tube overall length
 L1 = Oil pressure head length
 L2 = Drilling depth (L2' + L2'')
 L3 = Bar rest length
 L4 = Drill tube clamp length
 L5 = Length from drill tube tip and peripheral edge tip

$$\text{Drill tube length OAL} = L1 + L2 + L3 + L4 - L5$$

TRI-FINE



DCN-DCX	L5
16 - 16.7	34
16.71 - 17.7	34
17.71 - 18.9	34
18.91 - 20	34
20.01 - 21.8	32.5
21.81 - 21.99	33.5
22 - 24.1	35.5
24.11 - 26.4	35.5
26.41 - 28	35.5

FINE-BEAM



DCN-DCX	L5
25 - 28.7	40
28.71 - 33.3	42
33.31 - 36.2	47
36.21 - 39.6	50
39.61 - 43	55
43.01 - 51.7	60
51.71 - 56.2	66
56.21 - 65	71

UNIDEX



DCN-DCX	L5
38 - 43	45
43.01 - 51.7	55
51.71 - 56.2	56
56.21 - 65	66
65 - 79.99	75
80 - 111.99	83
112 - 147.99	87
148 - 183.99	86
184 - 255.99	101
256 - 291.99	106

MBU



DCN-DCX	L5
8 - 8.32	18
8.33 - 8.65	18
8.66 - 8.99	18
9 - 9.32	18
9.33 - 9.65	18
9.66 - 9.99	18
10 - 10.32	18
10.33 - 10.65	18
10.66 - 10.99	18
11 - 11.32	18
11.33 - 11.65	18
11.66 - 11.99	18
12 - 12.36	18
12.37 - 12.73	18
12.74 - 13.1	18
13.11 - 13.49	18
13.5 - 13.82	18
13.83 - 14.15	18
14.16 - 14.48	18
14.49 - 14.79	18

UTE



DCN-DCX	L5
12.6 - 12.92	19
12.93 - 12.99	19
13 - 13.25	19
13.26 - 13.6	19
13.61 - 13.93	19
13.94 - 13.99	19
14 - 14.26	19
14.27 - 14.6	19
14.61 - 14.93	19
14.94 - 15.26	19
15.27 - 15.59	19
15.6 - 15.96	20
15.97 - 16.32	20
16.33 - 16.7	20
16.71 - 17.03	20
17.04 - 17.36	20
17.37 - 17.7	20
17.71 - 18.09	19
18.1 - 18.48	19
18.49 - 18.9	19
18.91 - 19.26	19
19.27 - 19.62	19
19.63 - 20	19

BTU



DCN-DCX	L5
12.6 - 17.7	20
17.71 - 19.2	23
19.21 - 21.8	22
21.81 - 24.1	23
24.11 - 28.7	24
28.71 - 33.3	27
33.31 - 36.2	26
36.21 - 40.6	29
40.61 - 43	28
43.01 - 47	30
47.01 - 51.7	29
51.71 - 56.2	32
56.21 - 58.4	34
58.41 - 65	33



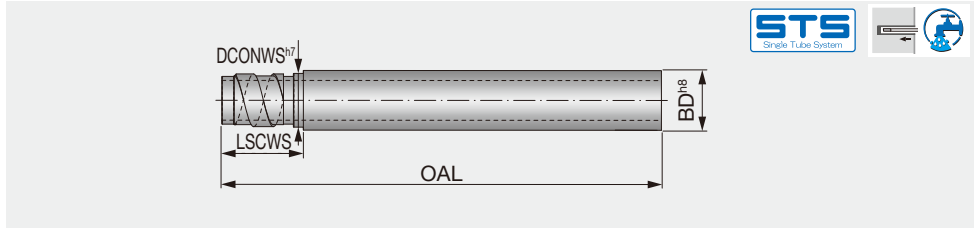

Designation	DCN-DCX	OAL	BD	DCONWS	LSCWS	Designation	DCN-DCX	OAL	BD	DCONWS	LSCWS
		Special length						Special length			
UB13-1	15.51 - 16	○	13	12.4	23	UB62	68 - 74.99	○	62	59	41
UB13-2	16.01 - 16.5	○	13	12.7	23	UB68	75 - 80.99	○	68	65	71
UB14-1	16.51 - 17.25	○	14	13.4	23	UB75	81 - 90.99	○	75	71	71
UB14-2	17.26 - 18	○	14	13.7	23	UB82	91 - 98.99	○	82	79	71
UB15	18.01 - 19	○	15	14.4	23	UB94	99 - 110.99	○	94	90	71
UB16.5	19.01 - 19.99	○	16.5	15.4	23	UB106	111 - 122.99	○	106	102	71
UB18	20 - 21.99	○	18	16.5	26	UB118	123 - 134.99	○	118	114	71
UB20	22 - 24.99	○	20	19	26	UB130	135 - 148.99	○	130	126	71
UB22	25 - 26.99	○	22	20	26	UB142	149 - 161.99	○	142	139	71
UB24	27 - 29.99	○	24	22	26	UB154	162 - 173.99	○	154	151	86
UB26	30 - 31.99	○	26	24	26	UB166	174 - 185.99	○	166	163	86
UB28	32 - 33.99	○	28	26	26	UB178	186 - 197.99	○	178	175	86
UB30	34 - 36.99	○	30	27	41	UB190	198 - 209.99	○	190	187	86
UB33	37 - 39.99	○	33	30	41	UB202	210 - 221.99	○	202	199	86
UB36	40 - 43.99	○	36	33	41	UB214	222 - 233.99	○	214	211	86
UB39	44 - 46.99	○	39	37	41	UB226	234 - 245.99	○	226	223	86
UB43	47 - 51.99	○	43	41	41	UB238	246 - 257.99	○	238	235	86
UB47	52 - 56.99	○	47	44	41	UB250	258 - 269.99	○	250	247	121
UB51	57 - 60.99	○	51	49	41	UB262	270 - 281.99	○	262	259	121
UB56	61 - 67.99	○	56	53	41	UB274	282 - 293.99	○	274	271	121

Please specify the length (OAL) when ordering.
e.g. For ø60 mm drill diameter / 2600 mm drill tube length: UB51X2600

○ : Item to be customized

■ Tube length for special drills

Please use the guide below to calculate the drill tube length.

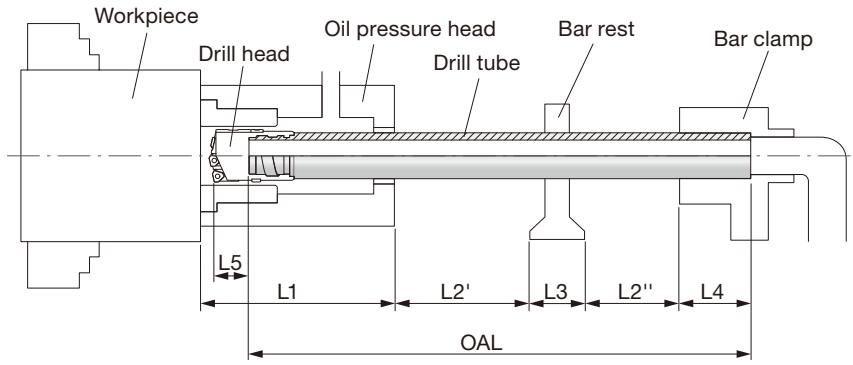

- OAL = Drill tube overall length
- L1 = Oil pressure head length
- L2 = Drilling depth (L2' + L2'')
- L3 = Bar rest length
- L4 = Drill tube clamp length
- L5 = Length from drill tube tip and peripheral edge tip

$$\text{Drill tube length OAL} = L1 + L2 + L3 + L4 - L5$$

TRI-FINE



DCN-DCX	L5
16 - 16.5	31.5
16.51 - 17.25	31.5
17.26 - 18	31.5
18.01 - 19	31.5
19.01 - 19.99	31.5
20 - 21.99	33
22 - 24.99	35
25	35
25.01 - 26.99	40
27 - 28	40

FINE-BEAM



DCN-DCX	L5
25 - 29.99	45
30 - 33.99	50
34 - 36.99	50
37 - 39.99	55
40 - 43.99	60
44 - 51.99	65
52 - 56.99	70
57 - 65	75

UNIDEX



DCN-DCX	L5
38 - 43.99	40
44 - 51.99	50
52 - 56.99	60
57 - 67.99	70
68 - 161.99	80
162 - 257.99	105
258 - 293.99	90

Grade
Insert
Ext. Toolholder
Int. Toolholder
Threading
Grooving
Miniature tool
Milling cutter
Endmill
Drilling tool
Tooling System
User's Guide
Index

A
B
C
D
E
F
G
H
I
J
K
L
M

OT & IT DTS

OT & IT - for double tube system

Outer tube and inner tube for double tube system (DTS)

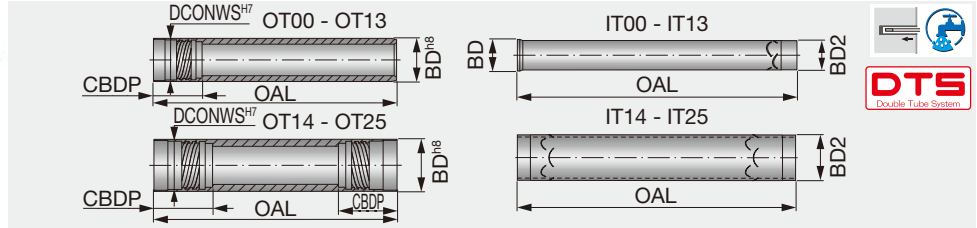

Outer tube (OT)

Designation	DCN-DCX	OAL Special length	BD	DCONWS	CBDP
OT00	18.4 - 20	○	18	16	27.5
OT01	20.01 - 21.8	○	19.5	18	30
OT02	21.81 - 24.1	○	21.5	19.5	30
OT03	24.11 - 26.4	○	23.5	21	30
OT04	26.41 - 28.7	○	26	23.5	33
OT05	28.71 - 31	○	28	25.5	33
OT06	31.01 - 33.3	○	30.5	28	33
OT07	33.31 - 36.2	○	33	30	40
OT08	36.21 - 39.6	○	35.5	33	40
OT09	39.61 - 43	○	39	36	40
OT10	43.01 - 47	○	42.5	39	40
OT11	47.01 - 51.7	○	46.5	43	44
OT12	51.71 - 56.2	○	51	47	44
OT13	56.21 - 65	○	55.5	51	44
OT14	65 - 66.99	○	56	52	75
OT15	70 - 72.99	○	62	58	75
OT16	73 - 79.99	○	68	63	75
OT17	80 - 86.99	○	75	70	97
OT18	87 - 99.99	○	82	77	97
OT19	100 - 111.99	○	94	89	97
OT20	112 - 123.99	○	106	101	118
OT21	124 - 135.99	○	118	113	118
OT22	136 - 147.99	○	130	125	118
OT23	148 - 159.99	○	142	137	139
OT24	160 - 171.99	○	154	149	139
OT25	172 - 183.99	○	166	161	139

Inner tube (IT)

Designation	DCN-DCX	OAL Special length	BD	BD2
IT00	18.4 - 20	○	12	10
IT01	20.01 - 21.8	○	14	12
IT02	21.81 - 24.1	○	15	13
IT03	24.11 - 26.4	○	16	14
IT04	26.41 - 28.7	○	18	16
IT05	28.71 - 31	○	20	18
IT06	31.01 - 33.3	○	22	20
IT07	33.31 - 36.2	○	24	22
IT08	36.21 - 39.6	○	26	24
IT09	39.61 - 43	○	29	27
IT10	43.01 - 47	○	32	30
IT11	47.01 - 51.7	○	35	32
IT12	51.71 - 56.2	○	39	36
IT13	56.21 - 65	○	43	40
IT14	65 - 66.99	○	-	40
IT15	70 - 72.99	○	-	44
IT16	73 - 79.99	○	-	48
IT17	80 - 86.99	○	-	54
IT18	87 - 99.99	○	-	60
IT19	100 - 111.99	○	-	70
IT20	112 - 123.99	○	-	80
IT21	124 - 135.99	○	-	80
IT22	136 - 147.99	○	-	95
IT23	148 - 159.99	○	-	100
IT24	160 - 171.99	○	-	120
IT25	172 - 183.99	○	-	130

Please specify the length (OAL) when ordering.

e.g. For ø60 mm drill diameter / 1070 mm drill outer tube length: OT13X1070

Please choose the inner tube length according to the guide below:

- ▶ tool diameter: ø18.40 - ø65.00 mm (OT00 - OT13) Inner tube length = Outer tube length + 30 mm
- ▶ tool diameter: ø65.00 - ø123.99 mm (OT14 - OT20) Inner tube length = Outer tube length + 190 mm
- ▶ tool diameter: ø124.00 - ø183.99 mm (OT21 - OT25) Inner tube length = Outer tube length + 220 mm

○ : Item to be customized

Reference pages: Drill head → **J118** (TRI-FINE DTS), **J123** (FINE-BEAM DTS), **J141 - J145** (UNIDEX DTS), **J155** (ETU)

Tube length for special drills

Please use the guide below to calculate the drill tube length.

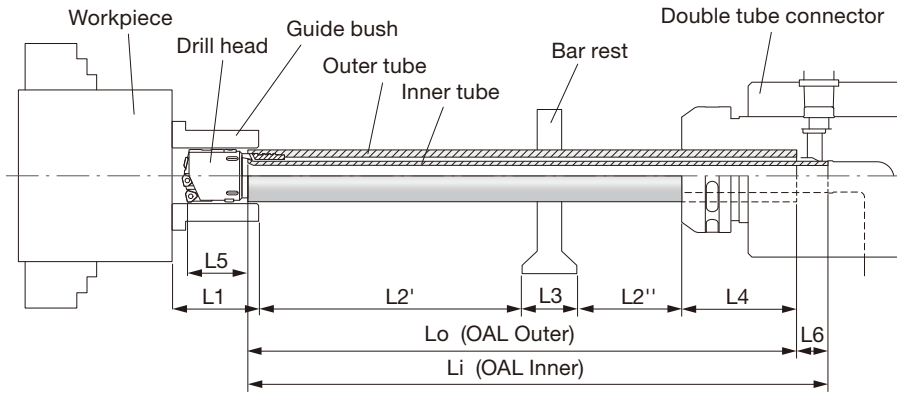

- Lo = Outer tube overall length
- Li = Inner tube overall length
- L1 = Guide bush length (or pilot hole depth)
- L2 = Drilling depth (L2' + L2'')
- L3 = Bar rest length
- L4 = Length of outer tube in connector*
- L5 = Length from drill tube tip and peripheral edge tip
- L6 = Difference between outer tube length and inner tube length**

$$\text{Outer tube overall length } Lo \approx L1 + L2 + L3 + L4 - L5$$

$$\text{Inner tube overall length } Li = Lo + L6$$

DTC	L4*	L6**
DTC 4R (OT00 - OT13)	120	30
DTC 5R (OT14 - OT20)	0	190
DTC 6R (OT212 - OT25)	0	220

(mm)

For smooth drill entry, make sure that the drill head is inside the guide bushing (or pilot hole) all the way up to 5 mm over the outer tube.

TRI-FINE



DCN-DCX	L5
18.4 - 20	31.5
20.01 - 21.8	33.5
21.81 - 21.99	33.5
22 - 24.1	35.5
24.11 - 25	35.5
25.01 - 26.4	37.5
26.41 - 28	37.5

FINE-BEAM



DCN-DCX	L5
25 - 26.4	40
26.41 - 31	42
31.01 - 33.3	47
33.31 - 36.2	50
36.21 - 39.6	55
39.61 - 47	60
47.01 - 51.7	66
51.71 - 65	71

UNIDEX



DCN-DCX	L5
38 - 43	45
43.01 - 47	55
47.01 - 51.7	51
51.71 - 56.2	56
56.21 - 65	66
65 - 79.99	75
80 - 111.99	83
112 - 147.99	87
148 - 183.99	86

ETU



DCN-DCX	L5
18.4 - 20	20
20.01 - 24.1	23
24.11 - 28.7	24
28.71 - 33.3	27
33.31 - 36.2	26
36.21 - 40.6	29
40.61 - 43	28
43.01 - 47	30
47.01 - 51.7	29
51.71 - 56.2	32
56.21 - 58.4	34
58.41 - 65	33

Conversion adapter

Adapter for external thread - internal thread conversion

An adapter to connect with a smaller tube diameter is also available upon request.

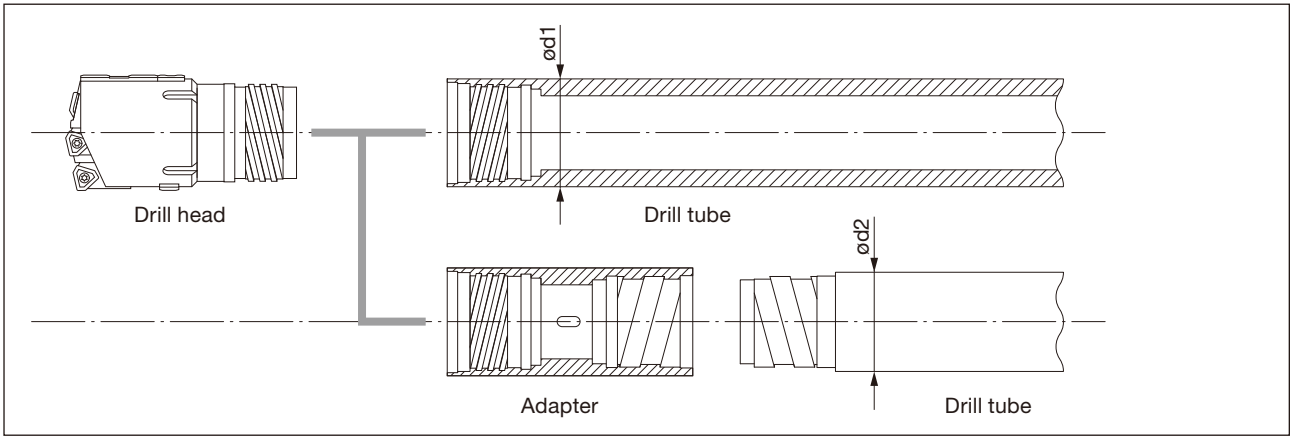

$\varnothing d1$: Outer diameter of the tube that is applicable for the drill head
 $\varnothing d2$: Outer diameter of the tube that is connected with the adapter

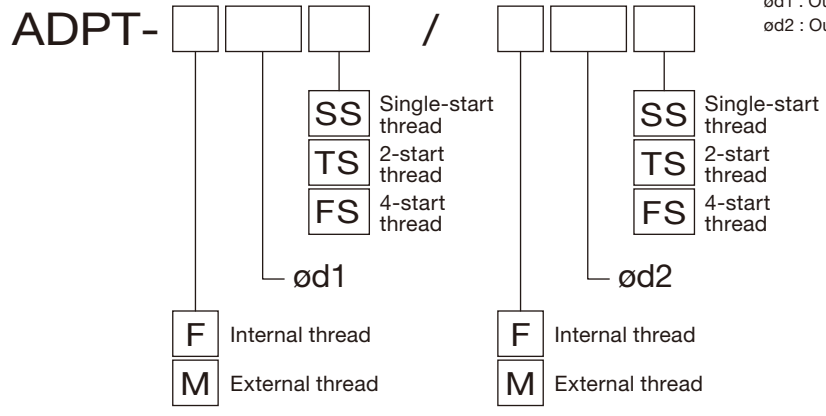

Designation example

For the conversion from ST11 to UB47

ADPT-F47FS / F47SS

↑ ↑
 ST11 UB47

HF Drill : Indexable drill for deep hole

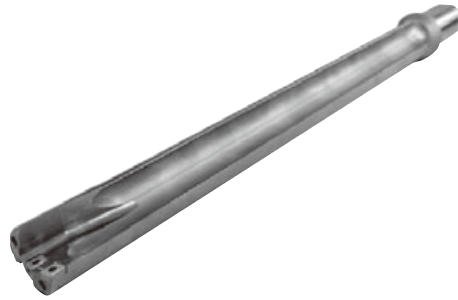

Economical for middle range deep hole drilling

- Tool diameter range: $\phi 30$ - $\phi 63$ mm (*)
- Drilling depth: 6xD - 14xD
- Shortened drilling time when using conventional machine

Effective machining on conventional machines

- Recommended for use on Horizontal M/C
- Can also be used on turning machine

Good chip evacuation

- FBM inserts enable best chip control
- Unique head design eliminates chip jamming
- Curved flute design ensures good chip evacuation

Easy to use, rigid drill body

- Direct mount inserts, no diameter adjustment necessary
- Body is made from heat treated tool steel

High quality surface finish

- Burnishing effect improves surface finish
- Possible to eliminate finish process

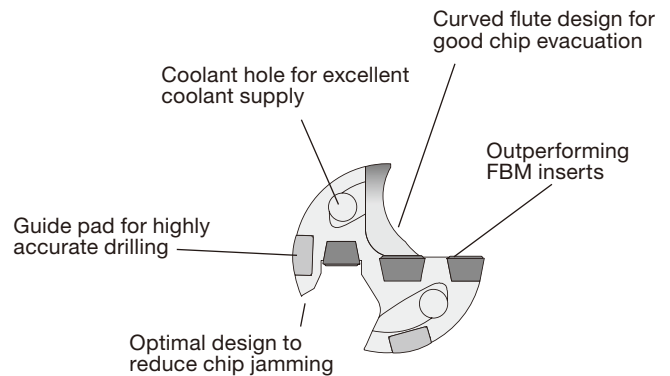

PRACTICAL EXAMPLE

Cutting conditions

Tool diameter DC: $\phi 30$ mm
 Drilling depth: 200 mm
 Workpiece material: S45C
 Cutting speed Vc: 100 m/min
 Feed f: 0.1 mm/rev
 Machine: BT50 M/C

No spiral marks caused by chips
 Burnishing effect by guide pads improves surface finish

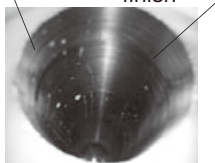

BT50 M/C Machining data

Excellent chip evacuation ensures the stable drilling on M/C.

Cutting speed Vc (m/min)

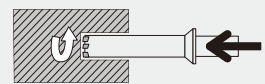
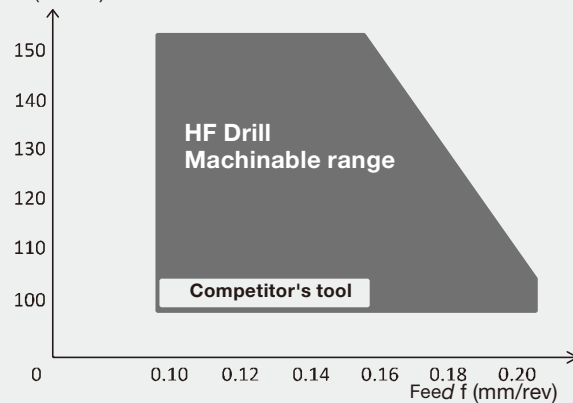

- Water-soluble coolant
- Pressure: 1.5 MPa
- Through spindle

Tool diameter DC: $\phi 30$ mm
 Drilling depth: 200 mm
 Workpiece material: S45C
 Cutting speed Vc: 100 - 150 m/min
 Feed f: 0.1 - 0.2 mm/rev
 Machine: BT50 Horizontal M/C (Max 11 kW)

Cautionary points in use

To start the tool, a pilot hole is required. (tolerance: + 0.1 to 0.15 mm)

Tool diameter DC (mm)	Pilot hole length H (mm)
$\phi 30 \sim \phi 39$	$10 \leq$
$\phi 39.01 \sim \phi 45$	$12.5 \leq$
$\phi 45.01 \sim \phi 57$	$15 \leq$
$\phi 57.01 \sim \phi 63$	$17.5 \leq$

- The pilot hole should ideally have a flat bottom, but generally an indexable drill is acceptable to create a pilot hole if the inner insert touches the bottom last.
- DrillForce-Meister series or TDX drills are recommended for a pilot hole drilling.



REAMMEISTER

TRM

Exchangeable head reamer, L/D = 1.5, 3, 5, 8

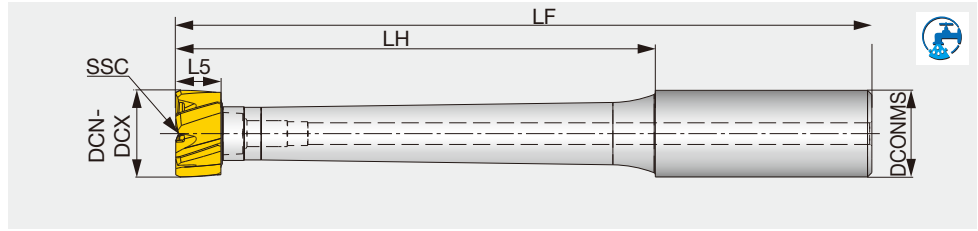

Designation	DCN	DCX	SSC	L/D	DCONMS	L5	LF	LH
TRM-T5-R16-1.5	11.5	13.5	T5	1.5	16	9.3	77.8	29.8
TRM-T6-R16-1.5	13.501	16	T6	1.5	16	9.4	81.5	33.5
TRM-T7-R20-1.5	16.001	20	T7	1.5	20	10.6	90.7	40.7
TRM-T8-R20-1.5	20.001	25.999	T8	1.5	20	12.8	101	51
TRM-T9-R32-1.5	26	32	T9	1.5	32	12.8	120.9	60.9
TRM-T5-R16-3	11.5	13.5	T5	3	16	9.3	97.8	49.8
TRM-T6-R16-3	13.501	16	T6	3	16	9.4	105.4	57.4
TRM-T7-R20-3	16.001	20	T7	3	20	10.6	120.6	70.6
TRM-T8-R20-3	20.001	25.999	T8	3	20	12.8	137.8	87.8
TRM-T9-R32-3	26	32	T9	3	32	12.8	167.1	107.1
TRM-T5-R16-5	11.5	13.5	T5	5	16	9.3	125	77
TRM-T6-R16-5	13.501	16	T6	5	16	9.4	137.4	89.4
TRM-T7-R20-5	16.001	20	T7	5	20	10.6	160.6	110.6
TRM-T8-R20-5	20.001	25.999	T8	5	20	12.8	187.8	137.8
TRM-T9-R32-5	26	32	T9	5	32	12.8	231.1	171.1
TRM-T5-R16-8	11.5	13.5	T5	8	16	9.3	165.5	117.5
TRM-T6-R16-8	13.501	16	T6	8	16	9.4	185.4	137.4
TRM-T7-R20-8	16.001	20	T7	8	20	10.6	220.6	170.6
TRM-T8-R20-8	20.001	25.999	T8	8	20	12.8	262.8	212.8
TRM-T9-R32-8	26	32	T9	8	32	12.8	327.1	267.1
TRMU-T5-R0.625-1.5	11.5	13.5	T5	1.5	15.875	9.3	77.7	29.7
TRMU-T6-R0.625-1.5	13.501	16	T6	1.5	15.875	9.4	81.5	33.5
TRMU-T7-R0.75-1.5	16.001	20	T7	1.5	19.05	10.6	90.7	40.6
TRMU-T8-R0.75-1.5	20.001	25.999	T8	1.5	19.05	12.8	101.1	51.1
TRMU-T9-R1.25-1.5	26	32	T9	1.5	31.75	12.8	120.9	61.0
TRMU-T5-R0.625-3	11.5	13.5	T5	3	15.875	9.3	97.8	49.8
TRMU-T6-R0.625-3	13.501	16	T6	3	15.875	9.4	105.4	57.4
TRMU-T7-R0.75-3	16.001	20	T7	3	19.05	10.6	120.4	70.6
TRMU-T8-R0.75-3	20.001	25.999	T8	3	19.05	12.8	137.7	87.6
TRMU-T9-R1.25-3	26	32	T9	3	31.75	12.8	167.1	106.9
TRMU-T5-R0.625-5	11.5	13.5	T5	5	15.875	9.3	125.0	77.0
TRMU-T6-R0.625-5	13.501	16	T6	5	15.875	9.4	137.4	89.4
TRMU-T7-R0.75-5	16.001	20	T7	5	19.05	10.6	160.5	110.5
TRMU-T8-R0.75-5	20.001	25.999	T8	5	19.05	12.8	187.7	137.7
TRMU-T9-R1.25-5	26	32	T9	5	31.75	12.8	231.1	171.2
TRMU-T5-R0.625-8	11.5	13.5	T5	8	15.875	9.3	165.4	117.3
TRMU-T6-R0.625-8	13.501	16	T6	8	15.875	9.4	185.4	137.4
TRMU-T7-R0.75-8	16.001	20	T7	8	19.05	10.6	220.5	170.7
TRMU-T8-R0.75-8	20.001	25.999	T8	8	19.05	12.8	262.9	212.9
TRMU-T9-R1.25-8	26	32	T9	8	31.75	12.8	327.2	267.0

Key and screw are included.

Maximum effective reaming depth = Head diameter(mm) x L/D ratio.

Ex. For a reamer with $\phi 12$ mm: $12 \text{ mm} \times 3D = 36 \text{ mm}$

SPARE PARTS



Designation	Screw	Key
TRM-T5-R16-1.5	SCR-TRM-T5	K-TRM-T5
TRM-T6-R16-1.5	SCR-TRM-T6	K-TRM-T6
TRM-T7-R20-1.5	SCR-TRM-T7	K-TRM-T7
TRM-T8-R20-1.5	SCR-TRM-T8	K-TRM-T8
TRM-T9-R32-1.5	SCR-TRM-T9	K-TRM-T9
TRM-T5-R16-3	SCR-TRM-T5	K-TRM-T5
TRM-T6-R16-3	SCR-TRM-T6	K-TRM-T6
TRM-T7-R20-3	SCR-TRM-T7	K-TRM-T7
TRM-T8-R20-3	SCR-TRM-T8	K-TRM-T8
TRM-T9-R32-3	SCR-TRM-T9	K-TRM-T9
TRM-T5-R16-5	SCR-TRM-T5	K-TRM-T5
TRM-T6-R16-5	SCR-TRM-T6	K-TRM-T6
TRM-T7-R20-5	SCR-TRM-T7	K-TRM-T7
TRM-T8-R20-5	SCR-TRM-T8	K-TRM-T8
TRM-T9-R32-5	SCR-TRM-T9	K-TRM-T9
TRM-T5-R16-8	SCR-TRM-T5	K-TRM-T5
TRM-T6-R16-8	SCR-TRM-T6	K-TRM-T6
TRM-T7-R20-8	SCR-TRM-T7	K-TRM-T7
TRM-T8-R20-8	SCR-TRM-T8	K-TRM-T8
TRM-T9-R32-8	SCR-TRM-T9	K-TRM-T9
TRMU-T5-R0.625-1.5	SCR-TRM-T5	K-TRM-T5
TRMU-T6-R0.625-1.5	SCR-TRM-T6	K-TRM-T6
TRMU-T7-R0.75-1.5	SCR-TRM-T7	K-TRM-T7
TRMU-T8-R0.75-1.5	SCR-TRM-T8	K-TRM-T8
TRMU-T9-R1.25-1.5	SCR-TRM-T9	K-TRM-T9
TRMU-T5-R0.625-3	SCR-TRM-T5	K-TRM-T5
TRMU-T6-R0.625-3	SCR-TRM-T6	K-TRM-T6
TRMU-T7-R0.75-3	SCR-TRM-T7	K-TRM-T7
TRMU-T8-R0.75-3	SCR-TRM-T8	K-TRM-T8
TRMU-T9-R1.25-3	SCR-TRM-T9	K-TRM-T9
TRMU-T5-R0.625-5	SCR-TRM-T5	K-TRM-T5
TRMU-T6-R0.625-5	SCR-TRM-T6	K-TRM-T6
TRMU-T7-R0.75-5	SCR-TRM-T7	K-TRM-T7
TRMU-T8-R0.75-5	SCR-TRM-T8	K-TRM-T8
TRMU-T9-R1.25-5	SCR-TRM-T9	K-TRM-T9
TRMU-T5-R0.625-8	SCR-TRM-T5	K-TRM-T5
TRMU-T6-R0.625-8	SCR-TRM-T6	K-TRM-T6
TRMU-T7-R0.75-8	SCR-TRM-T7	K-TRM-T7
TRMU-T8-R0.75-8	SCR-TRM-T8	K-TRM-T8
TRMU-T9-R1.25-8	SCR-TRM-T9	K-TRM-T9

Grade

A

Insert

B

Ext. Toolholder

C

Int. Toolholder

D

Threading

E

Grooving

F

Miniature tool

G

Milling cutter

H

Endmill

I

Drilling tool

J

Tooling System

K

User's Guide

L

Index

M

Reference pages: Head → **J166**, Standard cutting conditions → **J167**

REAMER HEAD

HRM-AS (for blind holes)

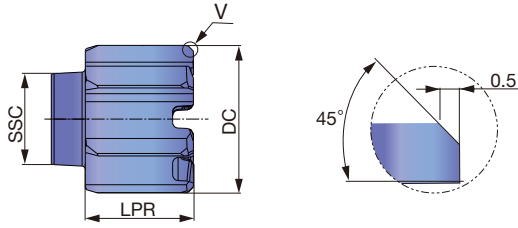

HRM-BL (for through holes)

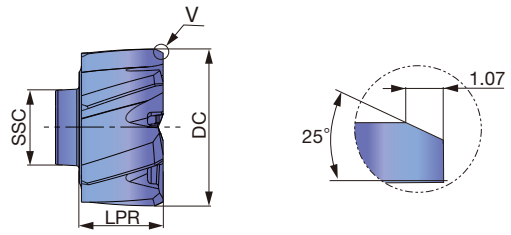

Designation	DC	AH725	SSC	LPR	CICT	Edge type	Flute type
HRM-11.501-AS-T5	11.501	●	T5	9.3	6	A	S
HRM-12.000-AS-T5	12	●	T5	9.3	6	A	S
HRM-12.700-AS-T5	12.7	●	T5	9.3	6	A	S
HRM-13.000-AS-T5	13	●	T5	9.3	6	A	S
HRM-13.500-AS-T5	13.5	●	T5	9.3	6	A	S
HRM-14.000-AS-T6	14	●	T6	9.4	6	A	S
HRM-15.000-AS-T6	15	●	T6	9.4	6	A	S
HRM-15.875-AS-T6	15.875	●	T6	9.4	6	A	S
HRM-16.000-AS-T6	16	●	T6	9.4	6	A	S
HRM-16.001-AS-T7	16.001	●	T7	10.6	6	A	S
HRM-17.000-AS-T7	17	●	T7	10.6	6	A	S
HRM-18.000-AS-T7	18	●	T7	10.6	6	A	S
HRM-19.000-AS-T7	19	●	T7	10.6	6	A	S
HRM-19.050-AS-T7	19.05	●	T7	10.6	6	A	S
HRM-20.000-AS-T7	20	●	T7	10.6	6	A	S
HRM-20.001-AS-T8	20.001	●	T8	12.8	8	A	S
HRM-21.000-AS-T8	21	●	T8	12.8	8	A	S
HRM-22.000-AS-T8	22	●	T8	12.8	8	A	S
HRM-23.000-AS-T8	23	●	T8	12.8	8	A	S
HRM-24.000-AS-T8	24	●	T8	12.8	8	A	S
HRM-25.000-AS-T8	25	●	T8	12.8	8	A	S
HRM-25.400-AS-T8	25.4	●	T8	12.8	8	A	S
HRM-26.000-AS-T9	26	●	T9	12.8	8	A	S
HRM-27.000-AS-T9	27	●	T9	12.8	8	A	S
HRM-28.000-AS-T9	28	●	T9	12.8	8	A	S
HRM-29.000-AS-T9	29	●	T9	12.8	8	A	S
HRM-30.000-AS-T9	30	●	T9	12.8	8	A	S
HRM-31.000-AS-T9	31	●	T9	12.8	8	A	S
HRM-31.750-AS-T9	31.75	●	T9	12.8	8	A	S
HRM-32.000-AS-T9	32	●	T9	12.8	8	A	S

Package quantity = 1 pcs.
●: Line up

Head diameter range	Tool diameter tolerance	Hole diameter tolerance*
ø11.500 - ø18.000	+0.015 / +0.011	+0.018 / 0
ø18.001 - ø30.000	+0.017 / +0.013	+0.021 / 0
ø30.001 - ø32.000	+0.021 / +0.016	+0.025 / 0

*Just for reference

All standard heads are designed to achieve H7 hole tolerance. Head diameters are produced so that the hole diameter achieved is close to the max tolerance limit.

Designation	DC	AH725	SSC	LPR	CICT	Edge type	Flute type
HRM-11.501-BL-T5	11.501	●	T5	9.3	6	B	L
HRM-12.000-BL-T5	12	●	T5	9.3	6	B	L
HRM-12.700-BL-T5	12.7	●	T5	9.3	6	B	L
HRM-13.000-BL-T5	13	●	T5	9.3	6	B	L
HRM-13.500-BL-T5	13.5	●	T5	9.3	6	B	L
HRM-14.000-BL-T6	14	●	T6	9.4	6	B	L
HRM-15.000-BL-T6	15	●	T6	9.4	6	B	L
HRM-15.875-BL-T6	15.875	●	T6	9.4	6	B	L
HRM-16.000-BL-T6	16	●	T6	9.4	6	B	L
HRM-16.001-BL-T7	16.001	●	T7	10.6	6	B	L
HRM-17.000-BL-T7	17	●	T7	10.6	6	B	L
HRM-18.000-BL-T7	18	●	T7	10.6	6	B	L
HRM-19.000-BL-T7	19	●	T7	10.6	6	B	L
HRM-19.050-BL-T7	19.05	●	T7	10.6	6	B	L
HRM-20.000-BL-T7	20	●	T7	10.6	6	B	L
HRM-20.001-BL-T8	20.001	●	T8	12.8	8	B	L
HRM-21.000-BL-T8	21	●	T8	12.8	8	B	L
HRM-22.000-BL-T8	22	●	T8	12.8	8	B	L
HRM-23.000-BL-T8	23	●	T8	12.8	8	B	L
HRM-24.000-BL-T8	24	●	T8	12.8	8	B	L
HRM-25.000-BL-T8	25	●	T8	12.8	8	B	L
HRM-25.400-BL-T8	25.4	●	T8	12.8	8	B	L
HRM-26.000-BL-T9	26	●	T9	12.8	8	B	L
HRM-27.000-BL-T9	27	●	T9	12.8	8	B	L
HRM-28.000-BL-T9	28	●	T9	12.8	8	B	L
HRM-29.000-BL-T9	29	●	T9	12.8	8	B	L
HRM-30.000-BL-T9	30	●	T9	12.8	8	B	L
HRM-31.000-BL-T9	31	●	T9	12.8	8	B	L
HRM-32.000-BL-T9	32	●	T9	12.8	8	B	L

Package quantity = 1 pcs.
●: Line up

Head diameter range	Tool diameter tolerance	Hole diameter tolerance*
ø11.500 - ø18.000	+0.015 / +0.011	+0.018 / 0
ø18.001 - ø30.000	+0.017 / +0.013	+0.021 / 0
ø30.001 - ø32.000	+0.021 / +0.016	+0.025 / 0

*Just for reference

All standard heads are designed to achieve H7 hole tolerance. Head diameters are produced so that the hole diameter achieved is close to the max tolerance limit.

STANDARD CUTTING CONDITIONS

Conversion table for feed per tooth

ISO	Workpiece materials	Hardness	Cutting speed Vc (m/min)	Feed: fz(mm/t)			
				AS: Straight flute (for blind holes)		BL: Left hand flute (for through holes)	
				ø11.5 - ø16	ø16 - ø32	ø11.5 - ø16	ø16 - ø32
P	Low carbon steel (C<0.3) SS400, SM490, S25C, E275A, etc.	- 200 HB	80 - 200	0.05 - 0.18	0.05 - 0.20	0.05 - 0.2	0.05 - 0.27
	Carbon steel (C>0.3) S45C, S55C, C45, C55, etc.	- 300 HB	80 - 150	0.05 - 0.15	0.05 - 0.18	0.05 - 0.18	0.05 - 0.25
	Low alloy steel (C<0.3) SCM415, etc.	- 200 HB	80 - 200	0.05 - 0.18	0.05 - 0.20	0.05 - 0.2	0.05 - 0.27
	Alloy steel (C>0.3) SCM440, SCr420, 42CrMo4, 20Cr4 etc.	- 300 HB	50 - 150	0.03 - 0.10	0.05 - 0.13	0.05 - 0.13	0.05 - 0.17
M	Stainless steel (Austenitic) SUS304, SUS316, X5CrNi18-9, X5CrNiMo17-12-3, etc.	- 200 HB	20 - 40	0.03 - 0.10	0.03 - 0.13	0.05 - 0.13	0.05 - 0.17
	Stainless steel (Martensitic and ferritic) SUS430, SUS416, X6Cr17, etc.	- 200 HB	20 - 40	0.03 - 0.10	0.03 - 0.13	0.05 - 0.13	0.05 - 0.17
	Stainless steel (Precipitation hardening) SUS630, X5CrNiCuNb16-4 etc.	-	20 - 40	0.03 - 0.10	0.03 - 0.13	0.05 - 0.13	0.05 - 0.17
K	Gray cast iron FC250, GG25, 250 etc.	150 - 250 HB	100 - 250	0.05 - 0.18	0.05 - 0.20	0.05 - 0.2	0.05 - 0.27
	Ductile cast iron FCD700, etc.	150 - 250 HB	80 - 200	0.05 - 0.15	0.05 - 0.18	0.05 - 0.18	0.05 - 0.25
N	Aluminum alloy	-	100 - 300	0.05 - 0.18	0.05 - 0.20	0.05 - 0.2	0.05 - 0.27
S	High temp. alloy Inconel718 etc.	- 40 HRC	15 - 50	0.03 - 0.06	0.03 - 0.08	0.05 - 0.1	0.05 - 0.13
	Titanium alloy Ti-6Al-4V etc.	- 40 HRC	30 - 60	0.03 - 0.10	0.03 - 0.13	0.05 - 0.13	0.05 - 0.17
H	Hardened steel	- 50 HRC	50 - 100	0.03-0.08	0.03 - 0.1	0.05-0.12	0.05 - 0.15

Conversion table for feed per revolution

ISO	Workpiece materials	Hardness	Cutting speed Vc (m/min)	Feed: f (mm/rev)					
				AS: Straight flute (for blind holes)			BL: Left hand flute (for through holes)		
				ø11.5 - ø16 6 flutes	ø16.001 - ø20 6 flutes	ø20.001 - ø32 8 flutes	ø11.5 - ø16 6 flutes	ø16.001 - ø20 6 flutes	ø20.001 - ø32 8 flutes
P	Low carbon steel (C<0.3) SS400, SM490, S25C, E275A, etc.	- 200 HB	80 - 200	0.3 - 1.08	0.3 - 1.2	0.4 - 1.6	0.3 - 1.2	0.3 - 1.62	0.4 - 2.16
	Carbon steel (C>0.3) S45C, S55C, C45, C55, etc.	- 300 HB	80 - 150	0.3 - 0.9	0.3 - 1.08	0.4 - 1.44	0.3 - 1.08	0.3 - 1.5	0.4 - 2
	Low alloy steel (C<0.3) SCM415, etc.	- 200 HB	80 - 200	0.3 - 1.08	0.3 - 1.2	0.4 - 1.6	0.3 - 1.2	0.3 - 1.2	0.4 - 2.16
	Alloy steel (C>0.3) SCM440, SCr420, 42CrMo4, 20Cr4 etc.	- 300 HB	50 - 150	0.18 - 0.6	0.3 - 0.78	0.4 - 1.04	0.3 - 0.78	0.3 - 1.02	0.4 - 1.36
M	Stainless steel (Austenitic) SUS304, SUS316, X5CrNi18-9, X5CrNiMo17-12-3, etc.	- 200 HB	20 - 40	0.18 - 0.6	0.18 - 0.78	0.24 - 1.04	0.3 - 0.78	0.3 - 1.02	0.4 - 1.36
	Stainless steel (Martensitic and ferritic) SUS430, SUS416, X6Cr17, etc.	- 200 HB	20 - 40	0.18 - 0.6	0.18 - 0.78	0.24 - 1.04	0.3 - 0.78	0.3 - 1.02	0.4 - 1.36
	Stainless steel (Precipitation hardening) SUS630, X5CrNiCuNb16-4 etc.	-	20 - 40	0.18 - 0.6	0.18 - 0.78	0.24 - 1.04	0.3 - 0.78	0.3 - 1.02	0.4 - 1.36
K	Gray cast iron FC250, GG25, 250 etc.	150 - 250 HB	100 - 250	0.3 - 1.08	0.3 - 1.2	0.4 - 1.6	0.3 - 1.2	0.3 - 1.62	0.4 - 2.16
	Ductile cast iron FCD700, etc.	150 - 250 HB	80 - 200	0.3 - 0.9	0.3 - 1.08	0.4 - 1.44	0.3 - 1.8	0.3 - 1.62	0.4 - 2
N	Aluminum alloy	-	100 - 300	0.3 - 1.08	0.3 - 1.2	0.4 - 1.6	0.3 - 1.2	0.3 - 1.62	0.4 - 2.16
S	High temp. alloy Inconel718 etc.	- 40 HRC	15 - 50	0.18 - 0.36	0.18 - 0.48	0.24 - 0.64	0.3 - 0.6	0.3 - 0.78	0.4 - 1.04
	Titanium alloy Ti-6Al-4V etc.	- 40 HRC	30 - 60	0.18 - 0.6	0.18 - 0.78	0.24 - 1.04	0.3 - 0.78	0.3 - 1.02	0.4 - 1.36
H	Hardened steel Over 40HRC etc.	- 50 HRC	50 - 100	0.18 - 0.48	0.18 - 0.6	0.24 - 0.8	0.3 - 0.72	0.3 - 0.9	0.4 - 1.2



Alphanumeric Index

Drilling

Designation	Product name	Page
A		
AOMT030204-N-□□DT	DrillMeister insert for special chamfering tool	J024
AOMT060204-C45	DrillMeister insert for special chamfering tool	J024
B		
BTU-...	Brazed drill head for STS	J152 - J154
C		
CDS-...	Solid drill for cast iron and aluminium alloy	J043
D		
DMC...	DrillMeister high precision machining head	J028, J029
DMF...	DrillMeister flat geometry head	J030
DMN...	DrillMeister non-ferrous metals drilling head	J032
DMH...	DrillMeister high strength cutting edge head	J031
DMP...	DrillMeister general purpose head	J025 - J027
DMX□□□□FL	Solid drill for cast iron and aluminium alloy, L/D=5	J056
DMX□□□□FM	Solid drill for cast iron and aluminium alloy, L/D=3	J056
DMX□□□□FS	Solid drill for cast iron and aluminium alloy, L/D=2	J055
DMX□□□□M	Solid drill for steel, L/D=3	J055
DMX□□□□S	Solid drill for steel, L/D=2	J054
DP...	Pilot drill for TDP	J088
DSE□□□□F02	GigaPowerDrill solid drill without coolant hole L/D=2	J051
DSE□□□□F03	GigaPowerDrill solid drill without coolant hole L/D=3	J052
DSM-CP140	GigaMiniDrill centering drill	J042
DSM-CP90	GigaMiniDrill centering drill	J042
DSM□□□□G...	GigaMiniDrill small diameter solid drill	J041
DSW□□□□-□□□□-□□DE3	SolidDrill without coolant hole L/D=3	J044
DSW□□□□-□□□□-□□DE5	SolidDrill without coolant hole L/D=5	J045
DSW□□□□-□□□□-□□DI5	SolidDrill with coolant hole L/D=5	J046
DSW□□□□-□□□□-□□DI8	SolidDrill with coolant hole L/D=8	J047
DSQ□□□□-□□□□-□□E3	Solid4FlutesDrill solid drill with coolant hole L/D=3	J057
DSQ□□□□-□□□□-□□E5	Solid4FlutesDrill solid drill with coolant hole L/D=5	J057
DSX□□□□□F03	GigaJetDrill solid drill with coolant hole L/D=8	J049
DSX□□□□□F05	GigaJetDrill solid drill with coolant hole L/D=5	J050
DSX□□□□□F08	GigaJetDrill solid drill with coolant hole L/D=8	J051
E		
ETU-...	Brazed drill head for DTS	J155
EZ...	TungDrill-Twisted · TungSix-Drill eccentric sleeve	J080
F		
FBH□□□□□□R-HF-P	FineBeam insert for peripheral cutting edge	J127
FBH□□□□□□R-G-P	DeepTri-Drill, FineBeam insert for peripheral cutting edge	J109, J127
FBM□□□□□□L-G-C	DeepTri-Drill, FineBeam insert for central cutting edge	J108, J126
FBM□□□□□□L-HF-C	FineBeam insert for central cutting edge	J126
FBM□□□□□□R-HF-I	FineBeam insert for intermediate cutting edge	J126
FBM□□□□□□R-DL-I	DeepTri-Drill, FineBeam insert for intermediate cutting edge	J109, J126
FBM□□□□□□R-G-I	DeepTri-Drill, FineBeam insert for intermediate cutting edge	J109, J126
FDC□□□□□L	Solid drill for cast iron and aluminium alloy, L/D=8	J054
FDC□□□□□S	Solid drill for cast iron and aluminium alloy, L/D=5	J053

Designation	Product name	Page
FDS1100	Solid drill for pre-drilling of tapping hole, L/D=2	J056
FNBM-□□D-...	FineBeam drill head for DTS, external quadruple thread	J123
FNBM-□□N-...	FineBeam drill head for STS, internal single thread	J122
FNBM-□□S-...	FineBeam drill head for STS, external quadruple thread	J121
FNTR-□□D-...	Tri-Fine drill head for DTS, external quadruple thread	J118
FNTR-□□N-...	Tri-Fine drill head for STS, internal single thread	J117
FNTR-□□S-...	Tri-Fine drill head for STS, internal quadruple thread	J116
FNTR-00□□S-...	Tri-Fine drill head for STS, internal quadruple thread	J116
FNTR-16.5N-...	Tri-Fine drill head for STS, internal single thread	J117
G		
GP...	Guide pad	J110, J120, J128, J147
H		
HRM-□□.□□□□-AS-T...	ReamMeister head with straight flute for blind holes	J166
HRM-□□.□□□□-BL-T...	ReamMeister head with left hand flute for through holes	J166
I		
IT...	DTS inner tube	J160
K		
KHS-TID10-19.99	DrillMeister head clamping key	J033
KUDTS□□E-...	Unidex adjustable diameter drill head for DTS, external quadruple thread	J141, J143, J145
KUSTS□□-...	Unidex adjustable diameter drill head for STS, external single thread	J130, J133, J136, J139
KUSTS□□E-...	Unidex adjustable diameter drill head for STS, external quadruple thread	J129, J132, J135, J138
L		
LOGT060204R-NDJ	DeepTri-Drill insert	J107
LPMT03X206R-D4	Drilling insert	J089
LPMT05X204-D4	Drilling insert	J089
M		
MBU-...	Brazed drill head for STS, external single thread	J150
MCTR□□.□□XM□□-10	DeepTri-Drill for lathes and machining centers L/D=10	J094
MCTR□□.□□XM□□-15	DeepTri-Drill for lathes and machining centers L/D=15	J096
MCTR□□.□□XM□□-20	DeepTri-Drill for lathes and machining centers L/D=20	J097
MCTR□□.□□XM□□-25	DeepTri-Drill for lathes and machining centers L/D=25	J098
MCTR□□.□□XM□□A-15	DeepTri-Drill for lathes and machining centers L/D=15	J096
MCTR□□.□□XM25A-10	DeepTri-Drill for lathes and machining centers L/D=10	J094
MCTR□□.□□XM25A-25	DeepTri-Drill for lathes and machining centers L/D=25	J098
MCTR□□.□□XU25.4-10	DeepTri-Drill for lathes and machining centers L/D=10	J094
MCTR□□.□□XU25.4-15	DeepTri-Drill for lathes and machining centers L/D=15	J096
MCTR□□.□□XU25.4-25	DeepTri-Drill for lathes and machining centers L/D=25	J098
MCTR□□.□□XU31.75-10	DeepTri-Drill for lathes and machining centers L/D=10	J094
MCTR□□.□□XU31.75-15	DeepTri-Drill for lathes and machining centers L/D=15	J096
MCTR□□.□□XU31.75-25	DeepTri-Drill for lathes and machining centers L/D=25	J098
MCTR□□.□□XFM□□-8	DeepTri-Drill for lathes and machining centers L/D=8	J094

Designation	Product name	Page
MCTR□□.□□XFM40-10	DeepTri-Drill for lathes and machining centers L/D=10	J095
MCTR□□.□□XFM40-15	DeepTri-Drill for lathes and machining centers L/D=15	J097
MCTR□□.□□XFU31.75-10	DeepTri-Drill for lathes and machining centers L/D=10	J095
MCTR□□.□□XFU31.75-15	DeepTri-Drill for lathes and machining centers L/D=15	J097
MCTR□□.□□XFU31.75-25	DeepTri-Drill for lathes and machining centers L/D=25	J099
MCTR□□.00XM□□-35	DeepTri-Drill for lathes and machining centers L/D=35	J100
MCTR□□.00XM□□-40	DeepTri-Drill for lathes and machining centers L/D=40	J100
MCTR12.00XM20-45	DeepTri-Drill for lathes and machining centers L/D=45	J100
MCTR17.45XU25.4A-10	DeepTri-Drill for lathes and machining centers L/D=10	J094
MCTR17.45XU25.4A-15	DeepTri-Drill for lathes and machining centers L/D=15	J096
MCTR17.45XU25.4A-25	DeepTri-Drill for lathes and machining centers L/D=25	J098
MCTR26.97XU31.75X-10	DeepTri-Drill for lathes and machining centers L/D=10	J094
MCTR26.97XU31.75X-15	DeepTri-Drill for lathes and machining centers L/D=15	J096
MCTR26.97XU31.75X-25	DeepTri-Drill for lathes and machining centers L/D=25	J098
MCTR30.00XFM40-25	DeepTri-Drill for lathes and machining centers L/D=25	J099
MCTRCH□□.□□XU25.4-25	DeepTri-Drill for lathes and machining centers. cross hole, L/D=25	J099
MCTRCH□□.00XM□□-25	DeepTri-Drill for lathes and machining centers. cross hole, L/D=25	J099
MCTRCH□□.00XM25A-25	DeepTri-Drill for lathes and machining centers. cross hole, L/D=25	J099
MCTRCH23.80XU31.75-25	DeepTri-Drill for lathes and machining centers. cross hole, L/D=25	J099
N		
NPMX080308R-G	Unidex insert	J146
NPMX080304R-B	Unidex insert	J146
O		
OT...	DTS outer tube	J160
S		
SHIMSET-GP0...	DeepTri-Drill, Tri-Fine, FineBeam, shim for fine adjustments of hole diameters	J111
SLJ□□□□L□□□□NA	Brazed gundrill	J113
SMF...	DrillForce-Meister flat geometry drill head	J038
SMP...	DrillForce-Meister general purpose drill head	J037
SMP□□□-□□□-GH	DrillForce-Meister regrinding holder	J039
SPM□□□□08ER-D	Drilling insert	J089
SPM□□□□ERD	Drilling insert	J089
SPMT060204-DS	Drilling insert	J089
SPMP831DS	Drilling insert	J089
ST...	Drill tube for STS, internal quadruple thread	J156
ST00...	Drill tube for STS, internal double/quadruple thread	J156
T		
TDB□□-□□F50-2.5	TungDrill-Big drill body	J081, J084
TDP□□-...	Indexable drill with pilot drill	J088
TDS□□□F□□-2	TungSix-Drill flat, L/D=2	J061
TDS□□□F□□-3	TungSix-Drill flat, L/D=3	J062
TDS□□□F□□-4	TungSix-Drill flat, L/D=4	J063
TDSCA□□-...	TungDrill-Big cartridge set, adjustable tool diameter	J081
TDSU□□□F□□-3	TungSix-Drill flat, L/D=3	J062
TDX□□□F□□-2	TungDrill-Twisted flat, L/D = 2	J068, J069
TDX□□□F□□-3	TungDrill-Twisted flat, L/D = 3	J070, J071
TDX□□□F□□-4	TungDrill-Twisted flat, L/D = 4	J072, J073
TDX□□□F□□-5	TungDrill-Twisted flat, L/D = 5	J074, J075
TDXCA□□-...	TungDrill-Bigcartridge set, adjustable tool diameter	J084
TDXCF□□□L...	TungDrill-Twisted · TungSix-Drill chamfering tool	J066, J079
TID□□□F□□-1.5	DrillMeister head exchangeable drill, flange type, L/D=1.5	J012
TID□□□F□□-3	DrillMeister head exchangeable drill, flange type, L/D=3	J014
TID□□□F□□-5	DrillMeister head exchangeable drill, flange type, L/D=5	J017
TID□□□F□□-8	DrillMeister head exchangeable drill, flange type, L/D=8	J020
TID□□□R□-2E	DrillMeister head exchangeable drill, round shank, L/D=2	J013
TID□□□R□-3.5	DrillMeister head exchangeable drill, round shank, L/D=3.5	J016
TID□□□R□-6	DrillMeister head exchangeable drill, round shank, L/D=6	J019
TID□□□R□-8	DrillMeister head exchangeable drill, round shank, L/D=8	J021
TID□□□R□□-2E	DrillMeister head exchangeable drill, round shank, L/D=2	J013
TID□□□R□□-3.5	DrillMeister head exchangeable drill, round shank, L/D=3.5	J016
TID□□□R□□-6	DrillMeister head exchangeable drill, round shank, L/D=6	J019
TID□□□R□□-8	DrillMeister head exchangeable drill, round shank, L/D=8	J021
TID□□□R□□-12	DrillMeister head exchangeable drill, round shank, L/D=12	J022
TID□□□R06-3	AddMeisterDrill head exchangeable drill, round shank, L/D=3	J011
TID□□□R06-5	AddMeisterDrill head exchangeable drill, round shank, L/D=5	J011
TIDC□□□C□-3	DrillMeister head exchangeable drill, straight flute L/D=3	J015
TIDC□□□C□-5	DrillMeister head exchangeable drill, straight flute L/D=5	J018
TIDC□□□C□□-3	DrillMeister head exchangeable drill, straight flute L/D=3	J015

Designation	Product name	Page
TIDC□□□C□□-5	DrillMeister head exchangeable drill, straight flute L/D=5	J018
TIDCF□□□-W...	DrillMeister chamfering holder	J023
TIS□□□F□□-3	DrillForce-Meister head exchangeable drill L/D=3	J034
TIS□□□F□□-5	DrillForce-Meister head exchangeable drill L/D=5	J035
TIS□□□F□□-8	DrillForce-Meister head exchangeable drill L/D=8	J036
TOHT□□□□□□R-NDJ	DeepTri-Drill, Tri-Fine insert	J107, J119
TOHT□□□□□□R-NDL	DeepTri-Drill, Tri-Fine insert	J108, J119
TPM□□□ZERD	Drilling insert	J089
TPMP83ZDS	Drilling insert	J089
TPMX□□□□□□R-B	Unidex insert	J146
TPMX□□□□□□R-BG	Unidex insert	J146
TPMX□□□□□□R-DT	Unidex insert	J146
TPMX□□□□□□R-G	Unidex insert	J146
TRLG□□.□□X□□□□-...	DeepTri-Drill for gundrill machines	J101, J102
TRLG□□.□□X800-...	DeepTri-Drill for gundrill machines	J101, J102
TRLG29.36X1828-FU31.75	DeepTri-Drill for gundrill machines	J104
TRLG30.00X□□□□-FM40	DeepTri-Drill for gundrill machines	J104
TRLG30.00X1650-FU38.1	DeepTri-Drill for gundrill machines	J104
TRLGCH□□.□□X□□□□-...	DeepTri-Drill for gundrill machines, cross hole	J103
TRM-T□-R□□-1.5	ReamMeister Indexable reamers	J164
TRM-T□-R□□-3	ReamMeister Indexable reamers	J164
TRM-T□-R□□-5	ReamMeister Indexable reamers	J164
TRM-T□-R□□-8	ReamMeister Indexable reamers	J164
TRMU-T□-R□.□□-1.5	ReamMeister Indexable reamers	J164
TRMU-T□-R□.□□-3	ReamMeister Indexable reamers	J164
TRMU-T□-R□.□□-5	ReamMeister Indexable reamers	J164
TRMU-T□-R□.□□-8	ReamMeister Indexable reamers	J164
TRMU-T□-R0.625-1.5	ReamMeister Indexable reamers	J164
TRMU-T□-R0.625-3	ReamMeister Indexable reamers	J164
TRMU-T□-R0.625-5	ReamMeister Indexable reamers	J164
TRMU-T□-R0.625-8	ReamMeister Indexable reamers	J164
U		
UB...	Drill tube for STS, external single thread	J158
UMBB...	Drill tube for MBU, internal single thread	J156
UTE-...	Brazed drill head for STS, external double/quadruple thread	J151
W		
WCMT□□□□□□-D□	Drilling insert	J089
WPMT□□□□□□-D3	TDP insert	J088
WWMU□□□□□□R-DJ	TungSix-Drill insert	J064, J082
WWMU□□□□□□R-DS	TungSix-Drill insert	J065, J082
X		
XCGT060300-□□DT	DrillMeister chamfering insert	J024
XHGR090300-45A	DrillMeister chamfering insert	J024
XHGR090300-60A	DrillMeister chamfering insert	J024
XHGT090300-30A	DrillMeister chamfering insert	J024
XHGX090700R-45A	Insert for TDxcf chamfering tool	J067, J079
XPMT□□□□□□R-DG	TungDrill-Twister, TungDrillBig insert	J077, J086
XPMT□□□□□□R-DJ	TungDrill-Twister, TungDrillBig insert	J076, J085
XPMT□□□□□□R-DS	TungDrill-Twister, TungDrillBig insert	J076, J085
XPMT□□□□□□R-DW	TungDrill-Twister, TungDrillBig insert	J077, J085
Z		
ZSGT060204R-NDJ	DeepTri-Drill insert	J107



JosS d.o.o.

Sokolska 45, 2000

Maribor, Slovenia

+386 2 421 57 20

+386 41 705 509

joss@joss.si

www.joss.si